

LED 3
LIGHT SOLUTIONS

Kreates

Krea Design progetta e costruisce apparecchi di illuminazione da oltre 50 anni.

Krea Design applica le tecnologie più avanzate del settore aggiornando costantemente le sua produzioni alle norme di sicurezza più attuali con consapevole assunzione del rischio, grande impegno del progetto, serietà di costruzione e cura nella fase di assemblaggio. Krea Design persegue il proprio motto di organizzazione ed efficienza nel suo significato più profondo che comporta:

- Professionalità dei propri uomini
- Adozione di tecnologie avanzate
- Flessibilità produttiva
- Versatilità commerciale
- Lungimiranza imprenditoriale

Tutti questi presupposti hanno creato l'ambiente ideale per maturare l'azienda al punto di presentare sul mercato questo catalogo **LED Light Solutions 3** che vuole essere, oltre che un valido strumento di vendita, anche la rappresentazione del proprio potenziale.

Krea Design designs and manufactures lighting fittings from more than 50 years.

Krea Design applies the most advanced technologies of lighting field adjoining constantly its productions to the newest security rules with conscious engagement of the risk, great obligation of the project, seriousness of construction and care on assembling. Krea Design follows its own motto of organization and efficiency in its deep meaning:

- Professionalism of its staff
- Adoption of the most advanced technologies
- Productive flexibility
- Commercial versatility
- Business far-sight

All these points have created the right environment to realize the company able to present on the market this catalogue **LED Light Solutions 3** that wants to be, both a valid selling instrument, and the symbol of its own potential.

Krea Design projeté et fabrique appareils d'illumination depuis 50 ans.

Krea Design appliqué les technologies de pointe de son secteur, en conformant constamment ses productions aux normes de sécurité les plus actuelles, avec une prise de risque consciente, un grand sérieux de conception et de construction et un soin minutieux durant l'assemblage.

Krea design est toujours fidèle à sa devise l'organisation et de performance dans sa signification qui comporte:

- le professionnalisme de son équipe
- l'adoption de technologies de pointe
- une flexibilité de production
- une souplesse commerciale
- une clairvoyance d'entrepreneur

Des critères qui ont permis de créer l'environnement idéal pour permettre à la société de présenter sur le marché ce catalogue **LED Light Solutions 3** qui désire être non seulement un instrument de vente valable, mais aussi de symbole de son potentiel.

Krea Design proyecta y fabrica aparatos de iluminación desde hace más de 50 años.

Krea Design aplica las más avanzadas tecnologías del sector actualizando constantemente su producción conforme a las normas de seguridad vigentes con una consciente asunción de riesgo, gran compromiso con el proyecto, seriedad en la fabricación y precisión en la fase de montaje. Krea Design persigue el principio expresado en su lema de organización y eficiencia en su más profundo sentido, que implica:

- La profesionalidad de sus trabajadores
- La adopción de tecnologías avanzadas
- La flexibilidad productiva
- La versatilidad comercial
- La previsión empresarial

Todos estos presupuestos han creado el ambiente ideal para la maduración de la empresa que la ha conducido a presentar al mercado este catálogo **LED Light Solutions 3** que pretende ser no sólo un válido instrumento de ventas sino también la representación de su propio potencial.













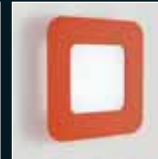

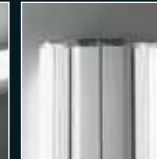



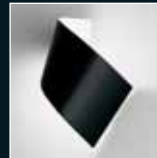









Krea Design seit über 50 Jahren Leuchten entwirft und produziert.

Krea Design setzt fortschrittlichste Technik ein und passt die Produktion kontinuierlich den neuesten technologischen Erkenntnissen und Sicherheitsvorschriften an; Gründlichkeit bei der Produktentwicklung und Konstruktion sowie besondere Sorgfalt bei der Verarbeitung und Montage zeichnen das Unternehmen und seine Produkte aus. Krea Design stellt höchste Ansprüche an seine Organisation sowie deren Effizienz und folgt dieser Unternehmensphilosophie umfassend, und zwar durch:

- Professionalität der Mitarbeiter
- Einsatz fortschrittlichster Technologien
- Flexibilität in der Produktion
- Marktgerechten Vertrieb
- Unternehmerische Weitsicht

Die stetige Umsetzung dieser Leitgedanken hat die Voraussetzungen für die Entwicklung des Unternehmens und seines Produktsortiments geschaffen, das in dem vorliegenden neuen Katalog präsentiert wird. Dieser Katalog **LED Light Solutions 3** soll ein nützliches Verkaufsinstrument sein, über das Unternehmen, das Produktprogramm und dessen Potential informieren.

Applique interni/esterni - Wall lights indoor/outdoor

								
Tab Led 18	Tab 1 Led 22	Tab 2 28	Tab Maxi 30	Forma 32	Split 34	Duo AP 42	Ergo 60 46	Ti-light AP 48
								
Retrò AP 66	Segno 68	Gina 70	Lollo 72	Aurora 74	Vip 76	Vela 78	Sirya 80	Trilyum AP 82
								
Domo 100	Equos 102	Rol 108	Plan 110	Biplan 114	Blik 116	Star C 120	Star L 124	Step 1 126
								
Kros 144	Asso 146	Polo 148	Riga 148					

Plafoniere interni/esterni - Ceiling bowls indoor/outdoor

								
Tab led 18	Tab Maxi 30	Tuttotondo/P 154	Yoyo/P 160	Cosmo/P 164	Vip 500 166	Duo DK AP 168	Split DK 170	Flash P 172
								
Mega metal 206	Gamma 208	Gamma metal 212	Beta 216	Delta 218	Griffe 220	Alma 224	Regolo 228	Quadro 230

Testaletto - Bead head units

		
Smart 250	Smart 1 250	Fly 254

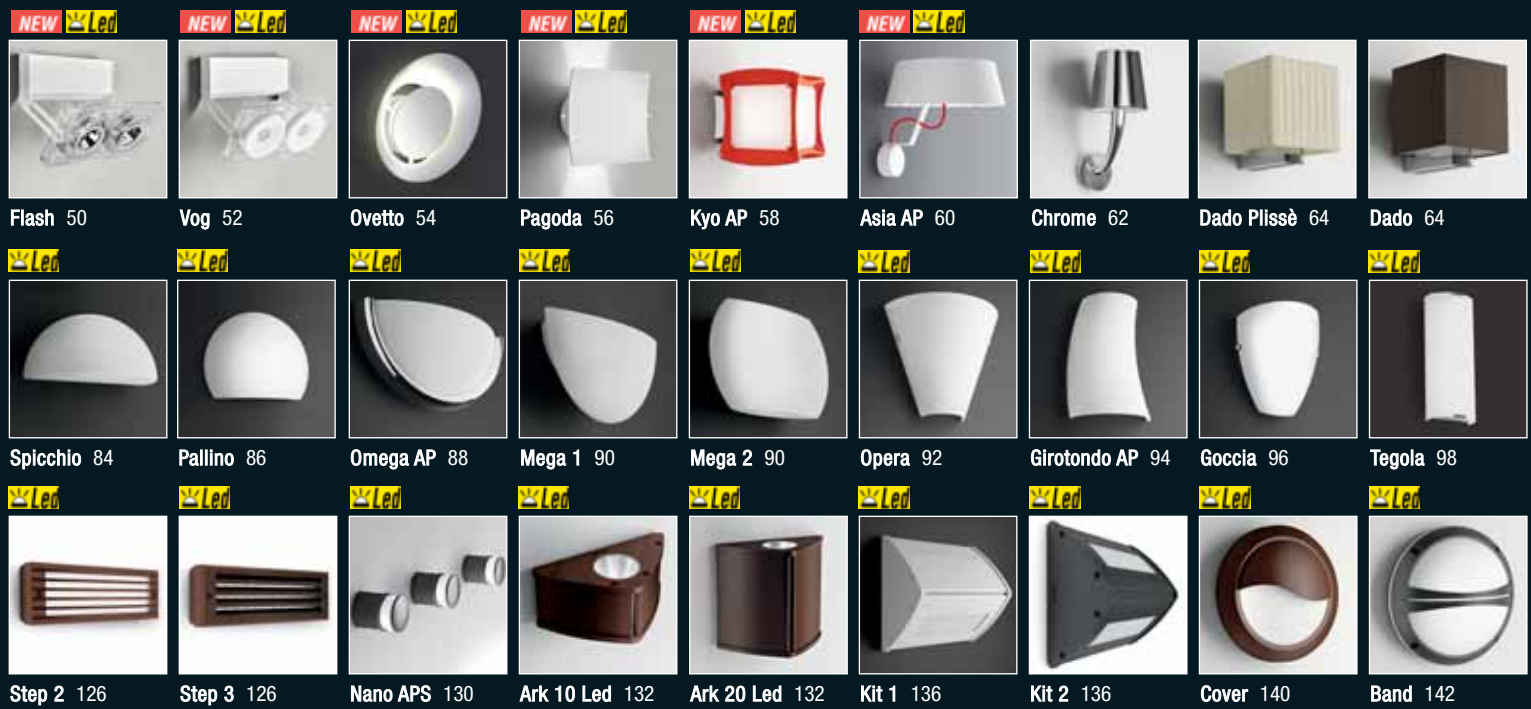

14 applique interni/esterni
wall lights indoor/outdoor

150 plafoniere interni/esterni
ceiling bowls indoor/outdoor

248 testataletto
bed head units

258 sospensioni
suspensions

















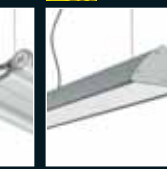

344 lampade
lamps

384 lampioni ed incassi
bollards & recessed lights











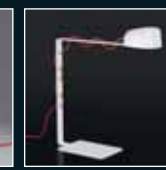

450 indice
index

NEW Nuovo prodotto New product
LED Versione LED LED version
RGB Versione RGB RGB version

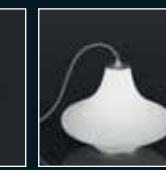
Sospensioni - Suspensions

 Tuttotondo 262	 Yoyo 268	 Tab S led 274	 Mono 278	 Mono DK 283	 Duo 284	 Duo DK 289	 360 LC 290	 Filo IP65 294
 Asia 320	 Open 324	 Nordica 328	 Girotondo 330	 Artika 332	 Work 334	 Railroad 336	 Trilyum 340	 Zeus 342

Lampade - Lamps

 Cosmo 348	 Cosmo T 350	 Kyo 352	 Asia 354	 Cut-off 356	 Avalon 358	 Alice 360	 July 362	 Girotondo G 364
 Trilyum 378	 Trilyum T 378	 Duo T 380	 Tris 382					

Lampioni ed incassi - Bollards & recessed lights

 Paloled 388	 Kuba-Kubamini 390	 Kuba 60-90 392	 Inka 1 394	 Inka 2 394	 Inka 3 394	 Inka 1/60-90 398	 Step 1/30-60 400	 Step 2/30-60 400
 Visor 422	 Park 424	 Plaza 428	 Box 432	 Polo 60-100 438	 Alfa 440	 Alfa 440	 B4 446	 B8 446

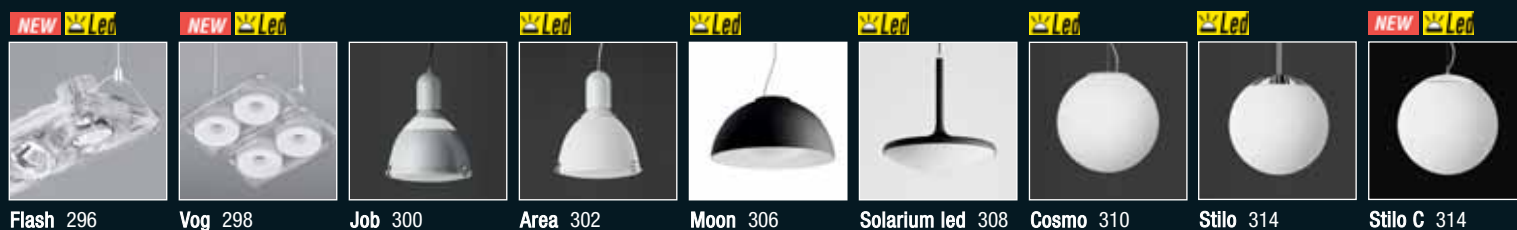

Flash 296 Vog 298 Job 300 Area 302 Moon 306 Solarium led 308 Cosmo 310 Stilo 314 Stilo C 314

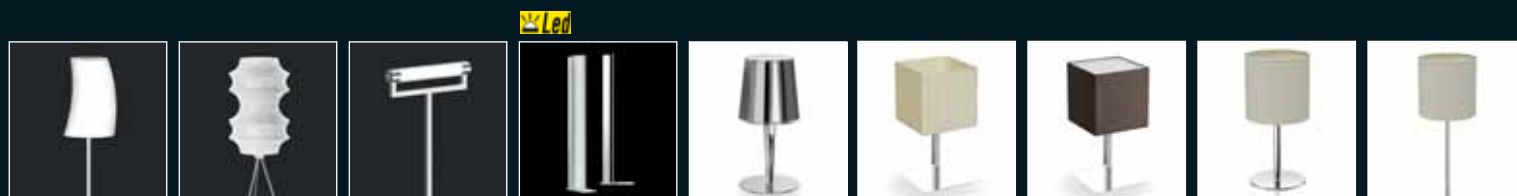

Girotondo T 364 Nordica T2 366 TI light T 368 Vitrum 370 Chrome G 372 Dado plissé G 374 Dado G 374 Retrò G 376 Retrò T 376

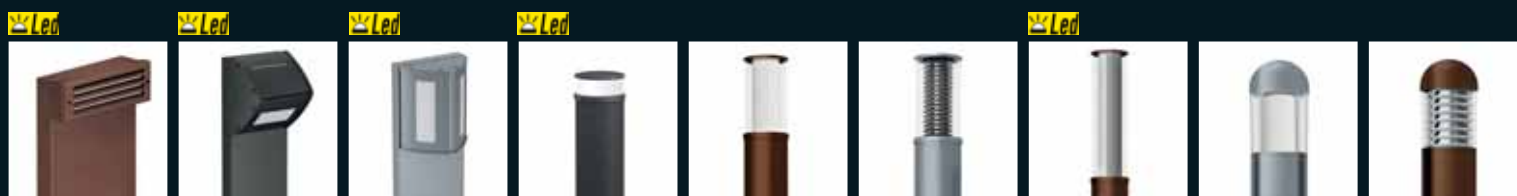

Step 3/30-60 400 Kit 1/60-100 404 Kit 2/60-100 404 Nano 408 Isy 410 Grill 412 Faro 414 Best 418 Land 420

NEW Nuovo prodotto *New product*
LED Versione LED *LED version*
RGB Versione RGB *RGB version*

14 applique interni/esterni
wall lights indoor/outdoor

150 plafoniere interni/esterni
ceiling bowls indoor/outdoor

248 testaletto
bed head units

258 sospensioni
suspensions

344 lampade
lamps

384 lampioni ed incassi
bollards & recessed lights

450 indice
index

PUNTI DI FORZA

Da sempre, la celerità d'evasione degli ordini accompagna la filosofia di Krea Design, aspetto che si evince anche nei tempi brevissimi necessari per redigere un'offerta commerciale o per valutare una richiesta speciale.

Le risposte al cliente sono sempre rapide e tempestive, sempre attente alle reali esigenze e con un'attenta valutazione delle problematiche tecniche.

Lo staff commerciale, unitamente all'ufficio tecnico e alla progettazione, è in grado di soddisfare anche le richieste speciali come, ad esempio, la realizzazione di piccole serie di apparecchi "su misura". Questa capacità, ben oltre la semplice personalizzazione del colore o della finitura, ci permette di produrre modelli su esclusivo disegno del cliente.

STRONG POINTS

Speed in fulfilling orders has always been part of the Krea Design philosophy, a feature that is also evident in the short time needed to draw up an estimate or evaluate a special request.

Replies to clients are always fast and timely, always attentive to their real needs and with a careful evaluation of technical problems.

The commercial staff, together with the technical office and design team, is always able to satisfy special requests, such as the creation of small series of "custom made" fittings.

This ability, which goes far beyond the mere personalization of colours or finishes, allows us to produce models to the client's exclusive design.

POINTS FORTS

La rapidité d'exécution des commandes accompagne depuis toujours la philosophie de Krea Design. C'est un aspect qui se remarque également dans les délais très brefs nécessaires pour rédiger l'offre commerciale ou pour évaluer une demande particulière. Les réponses données au client sont toujours rapides et opportunes, toujours attentives aux exigences réelles et accompagnées d'une évaluation attentive des problèmes techniques.

L'équipe commerciale épaulée par le bureau technique et de conception, est en mesure de satisfaire même des demandes spéciales comme par exemple la réalisation de petites séries d'appareils "sur mesure". Cette capacité, bien au-delà de la simple personnalisation de la couleur ou de la finition, nous permet de produire des modèles en suivant le dessin exclusif du client.

PUNTOS FUERTES

Desde siempre, la rapidez en el despacho de los pedidos acompaña la filosofía de Krea Design, lo que se refleja también en el breve tiempo necesario para emitir una oferta de venta o evaluar una solicitud especial.

La respuesta al cliente es siempre rápida y oportuna, con gran atención a las exigencias reales y a las eventuales problemáticas técnicas.

El personal de ventas, junto al personal de la oficina técnica y de planificación de proyectos, tiene la capacidad de satisfacer incluso las exigencias más particulares, como por ejemplo la realización de pequeñas series de aparatos "a medida". Esta capacidad va mucho más allá de la simple personalización del color o los acabados y permite la producción de modelos en base a los diseños exclusivos suministrados por el cliente.

UNSERE STÄRKEN

Die rasche Bearbeitung der Bestellungen ist seit jeher Teil der Philosophie von Krea Design, ein Aspekt, der auch aus der kurzen Zeit ersichtlich ist, die aufgewendet wird, um ein Angebot zu verfassen oder eine Sonderanfrage zu bewerten.

Die Antworten an den Kunden erfolgen stets rasch und rechtzeitig, sie berücksichtigen stets die echten Bedürfnisse und enthalten eine sorgfältige Bewertung der technischen Probleme.

Das Vertriebsteam ist gemeinsam mit dem Technischen Büro und dem Planungsbüro in der Lage, auch Sonderanfragen nachzukommen, wie zum Beispiel der Realisierung kleiner „maßgeschneiderter“ Geräteserien. Diese Fähigkeit, die über die einfache kundengerechte Gestaltung von Farbe oder Finish hinausgeht, ermöglicht es uns, Modelle nach dem exklusiven Entwurf des Kunden herzustellen.

Tabella delle caratteristiche proprie di ogni versione
 Table of each version's particular features
 Tableau des caractéristiques propre à chaque version
 Tabla de la características de cada versión
 Tabelle mit den Eigenschaften jeder Ausführung

Nome della serie e del modello
 Series and model name
 Nom de la série et du modèle
 Nombre de la serie y del modelo
 Serien - und Modellname



Richiamo dimensionale
 Dimensions
 Rappel des dimensions
 Dimensiones
 Verweis auf die Dimensionen

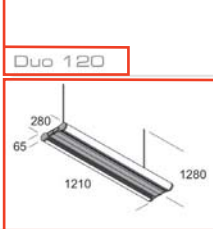

Classificazione degli apparecchi per tipologia di cablaggio
 Classification of fixtures by wiring type
 Classification des appareils par typologie de câblage
 Clasificación de los aparatos por tipo de cableado
 Klassifizierung der Geräte nach Verkabelungsart

Articolo Item		CR	AL	W _{max}		LUMEN		LUMEN/W	
Codice Code									
Led	duo 120 led-W	74890	74896	50	led	7240	IP20	145	C
Led	duo 120S led-W	74900	74906	91,6	led	12520	IP20	137	C
Led DM	duo 120S DM led-W	74910	74916	91,6	led	12520	IP20	137	C
Led EM	duo 120 EM led-W	74920	74926	50	led	7240	IP20	145	C
Led EM	duo 120S EM led-W	74930	74936	91,6	led	12520	IP20	137	C
Led	duo 120 led-N	74940	74946	50	led	7240	IP20	145	C
Led	duo 120S led-N	74950	74956	91,6	led	12520	IP20	137	C
Led DM	duo 120S DM led-N	74960	74966	91,6	led	12520	IP20	137	C
Led EM	duo 120 EM led-N	74970	74976	50	led	7240	IP20	145	C
Led EM	duo 120S EM led-N	74980	74986	91,6	led	12520	IP20	137	C
EL	duo 120/2x54 EL	78610	78616	2x54	G5	10000	IP20	93	A
	duo 120/4x54 EL	78650	78656	4x54	G5	20000	IP20	93	B
DM	duo 120/4x54 DM	79240	79246	4x54	G5	20000	IP20	93	B
EM	duo 120/2x54 EM	70040	70046	2x54	G5	10000	IP20	93	A
	duo 120/4x54 EM	70060	70066	4x54	G5	20000	IP20	93	B

Efficienza luminosa
 Luminous efficiency
 Efficacité lumineuse
 Eficiencia luminosa
 Leuchteffizienz

Colori disponibili
 Available colours
 Couleurs disponibles
 Colores disponibles
 Erhältlichen Farben

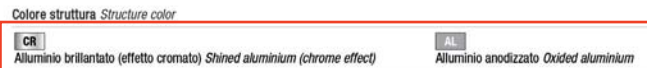

Nuova versione New version

Nuove versioni
 New models
 Nouveau modèle
 Nuevo modelo
 Neues Modell

Informazioni aggiuntive
 Additional information
 Informations complémentaires
 Información adicional
 Weitere Informationen

Equipaggiata con led 3000K - Equipped with led 3000K
 Equipaggiata con led 4000K - Equipped with led 4000K

Dimmerabile PUSH/DALI
 Dimmable PUSH/DALI (info page10)

Emergenza (SA) 1h di serie - 3h a richiesta
 Emergency 1h standard - 3h on request

Estensione gamma
 Range extension
 Extension de gamme
 Extensión de línea
 Zeile extension

Impiego suggerito
 Suggested use
 Utilisation suggérée
 Uso sugerido
 Empfohlene Anwendung

Famiglia prodotto Product family	Appique Wall lights Pag. 34-42	Plafoniere Ceiling bows Pag. 168-170	Sospensioni Suspensions Pag. 278	Lampade Lamps Pag. 380-382
-------------------------------------	-----------------------------------	---	-------------------------------------	-------------------------------

Corrispondenza alle pagine delle lampade appartenenti alla stessa collezione
 Page numbers for bulbs belonging to the same collection
 Correspondance des pages des lampes appartenant à la même collection
 Referencia a las páginas de las lámparas que pertenecen a la misma colección
 Entsprechung mit den Seiten der Leuchten aus der gleichen Kollektion

Rappresentazione della curva fotometrica attraverso diagramma polare
 Polar diagram of the photometric curve
 Représentation de la courbe photométrique par le diagramme polaire
 Representación de la curva fotométrica mediante un diagrama polar
 Darstellung der fotometrischen Kurve über das Polardiagramm

Emissione luminosa rispetto alla posizione di installazione
 Light emission according to position of installation
 Emission lumineuse par rapport à la position d'installation
 Emisión luminosa de acuerdo a la posición de instalación
 Lichtemission im Verhältnis zur Installationsposition

14 applique interni/esterni
wall lights indoor/outdoor

150 plafoniere interni/esterni
ceiling bows indoor/outdoor

248 testaletto
bed head units

258 sospensioni
suspensions

344 lampade
lamps

384 lampioni ed incassi
bollards & recessed lights

450 indice
index

	Nuovo prodotto New product Nouveau produit Nuevo producto Neues Produkt		Efficienza luminosa Luminous efficiency Efficacité lumineuse Eficiencia luminosa Leuchteffizienz
	Attacco portalampada Lampholder Douille Portalampara Lampensockel		Incandescenza Incandescent Incandescent Incandescencia Glühlampe
	Lampada alogena Halogen lamp Lampe halogène Lámpara halogena Halogenlampe		Incandescenza Incandescent Incandescent Incandescencia Glühlampe
	Alimentatore elettronico hf Electronic ballast hf Ballast électronique hf Balasto electrónico hf Vorschaltgerät elektronisch hf		Emergenza permanente (sa) 1h di serie - 3h a richiesta Maintained light emergency 1h standard - 3h option Emergency permanent 1h standard - 3h option Emergencia permanente 1h standard - 3h option Notleuchte dauerschaltung 1h serienmäßig - 3h auf anfrage
	Dimmerabile PUSH/DALI Dimmable PUSH/DALI Graduable PUSH/DALI Regulable PUSH/DALI Dimmbar PUSH/DALI		Lampada a scarica con alim. elettronico Discharge lamp with electronic ballast Lampe à décharge avec ballast électronique Lámpara de descarga con balasto electrónico Entladungslampe mit elektronischem vorschaltgerät
	Miscelazione colore RGB digitale Digital color mixing RGB Couleur variable RGB digitale Color variable RGB digitale Farbmischung RGB digital		Miscelazione colore RGB DALI Color mixing RGB DALI Couleur variable RGB DALI Color variable RGB DALI Farbmischung RGB DALI
	Miscelazione colore RGB digitale + Fluo Dimmerabile PUSH Digital color mixing RGB + Fluo Dimmable PUSH Couleur variable RGB digitale + Fluo Graduable PUSH Color variable RGB digitale + Fluo Regulable PUSH Farbmischung RGB digital + Fluo Dimmbar PUSH		Miscelazione colore RGB DALI + Fluo Dimmerabile DALI DALI color mixing RGB + Fluo Dimmable DALI Couleur variable RGB DALI + Fluo Graduable DALI Color variable RGB DALI + Fluo Regulable DALI Farbmischung RGB DALI + Fluo Dimmbar DALI
	Miscelazione colore RGB digitale + led 3000K Dimmerabile PUSH Digital color mixing RGB + led 3000K Dimmable PUSH Couleur variable RGB digitale + led 3000K Graduable PUSH Color variable RGB digitale + led 3000K Regulable PUSH Farbmischung RGB digital + led 3000K Dimmbar PUSH		Miscelazione colore RGB DALI + led 3000K Dimmerabile DALI DALI color mixing RGB + led 3000K Dimmable DALI Couleur variable RGB DALI + led 3000K Graduable DALI Color variable RGB DALI + led 3000K Regulable DALI Farbmischung RGB DALI + led 3000K Dimmbar DALI
	Miscelazione colore RGB digitale + led 4000K Dimmerabile PUSH Digital color mixing RGB + led 4000K Dimmable PUSH Couleur variable RGB digitale + led 4000K Graduable PUSH Color variable RGB digitale + led 4000K Regulable PUSH Farbmischung RGB digital + led 4000K Dimmbar PUSH		Miscelazione colore RGB DALI + led 4000K Dimmerabile DALI DALI color mixing RGB + led 4000K Dimmable DALI Couleur variable RGB DALI + led 4000K Graduable DALI Color variable RGB DALI + led 4000K Regulable DALI Farbmischung RGB DALI + led 4000K Dimmbar DALI
	Equipaggiata con led 3000K luce calda Equipped with led 3000K warm light Équipée avec led 3000K lumière chaude Suministrada con led 3000K luz cálida Ausgestattet mit led 3000K warmes Licht		Dimmerabile PUSH/DALI - led 3000K Dimmable PUSH/DALI - led 3000K Graduable PUS/DALI - led 3000K Regulable PUSH/DALI - led 3000K Dimmbar PUSH/DALI - led 3000K
	Equipaggiata con led 4000K luce naturale Equipped with led 4000K natural light Équipée avec led 4000K lumière naturelle Suministrada con led 4000K luz natural Ausgestattet mit led 4000K natürliche Licht		Dimmerabile PUSH/DALI - led 4000K Dimmable PUSH/DALI - led 4000K Graduable PUS/DALI - led 4000K Regulable PUSH/DALI - led 4000K Dimmbar PUSH/DALI - led 4000K
	Dimmerabile PUSH - led 3000K Dimmable PUSH - led 3000K Graduable PUSH - led 3000K Regulable PUSH - led 3000K Dimmbar PUSH - led 3000K		Dimmerabile DALI - led 3000K Dimmable DALI - led 3000K Graduable DALI - led 3000K Regulable DALI - led 3000K Dimmbar DALI - led 3000K
	Dimmerabile PUSH - led 4000K Dimmable PUSH - led 4000K Graduable PUSH - led 4000K Regulable PUSH - led 4000K Dimmbar PUSH - led 4000K		Dimmerabile DALI - led 4000K Dimmable DALI - led 4000K Graduable DALI - led 4000K Regulable DALI - led 4000K Dimmbar DALI - led 4000K
	Emergenza (sa) 1h di serie - 3h a richiesta - led 3000K Emergency 1h standard - 3h option - led 3000K Emergencia 1h standard - 3h option - led 3000K Emergencia 1h standard - 3h option - led 3000K Notleuchte 1h serienmäßig - 3h auf Anfrage - led 3000K		Alimentatore remoto 24V - led 3000K Remote driver 24V - led 3000K Alimentation 24V a distancia - led 3000K Alimentación 24V a distancia - led 3000K Fernbedienung 24V - led 3000K
	Emergenza (sa) 1h di serie - 3h a richiesta - led 4000K Emergency 1h standard - 3h option - led 4000K Emergencia 1h standard - 3h option - led 4000K Emergencia 1h standard - 3h option - led 4000K Notleuchte 1h serienmäßig - 3h auf Anfrage - led 4000K		Alimentatore remoto 24V - led 4000K Remote driver 24V - led 4000K Alimentation 24V a distancia - led 4000K Alimentación 24V a distancia - led 4000K Fernbedienung 24V - led 4000K
	Dati fotometrici Photometric data Données photométrique Datos fotométricos Fotometrische daten		Fascio luminoso Light beam Faisceau lumineux Rayo de luz Lichtbündel
	Massima potenza della lampadina Max bulb power Puissance maximale de l'ampoule Maxima potencia de la bombilla Max leistung der Glühlampe		Protetto contro la penetrazione di corpi solidi ø 12 mm Protection against penetration of solid bodies ø 12 mm Protection contre pénétrations des corps pleins ø 12 mm Proteccion contra la penetracion de cuerpos solidos ø 12 mm Schutz vor dem eindringen von festkörpern ø 12 mm
	Isolamento classe I Isolation class I Classe d'isolement I Clase de aislamiento I Isolierung Klasse I		Protetto contro la penetrazione di corpi solidi ø 1 mm Protection against penetration of solid bodies ø 1 mm Protection contre pénétrations des corps pleins ø 1 mm Proteccion contra la penetracion de cuerpos solidos ø 1 mm Schutz vor dem eindringen von festkörpern ø 1 mm
	Isolamento classe II Isolation class II Classe d'isolement II Clase de aislamiento II Isolierung Klasse II		Protetto contro la penetrazione di corpi solidi ø 1 mm e spruzzi d'acqua Protection against penetration of solid bodies ø 1 mm and water sprays Protection contre pénétrations des corps pleins ø 1 mm et projections d'eau Proteccion contra la penetracion de cuerpos solidos ø 1 mm y aerosoles de agua Schutz vor dem eindringen von festkörpern ø 1 mm und wasserspritzern
	Isolamento classe III Isolation class III Classe d'isolement III Clase de aislamiento III Isolierung Klasse III		Protetto contro la penetrazione della polvere e spruzzi d'acqua Protection against penetration of dust and water sprays Protection contre pénétrations de la poussière et projections d'eau Proteccion contra la penetracion de polvo y aerosoles de agua Schutz vor dem eindringen von staub und wasserspritzern
	Consigliato per uso interno ed esterno Recommended for indoor and outdoor use Recommandé pour une utilisation intérieure et extérieure Recomendado para uso en interiores y al aire libre Empfohlen für innen- und Außenbereich		Protetto contro la penetrazione della polvere e da getti d'acqua Protection against penetration of dust and water jets Protection contre pénétrations de la poussière et jets d'eau Proteccion contra la penetracion de polvo y jets de agua Schutz vor dem eindringen von staub und wasserstrahlen
	Consigliato per uso in esterno Recommended for outdoor use Recommandé pour une utilisation extérieure Recomendado para uso al aire libre Empfohlen für Außenbereich		Apparecchio per Ospedali Fitting for Hospitals Appareil pour Hôpitaux Aparato para Hospitales Gerät für Hospitales
	Consigliato per uso in interno Recommended for indoor use Recommandé pour une utilisation intérieure Recomendado para uso en interiores Empfohlen für Innenbereich		Apparecchio per Case di Riposo e Assistenza per gli Anziani Fitting for Care Homes and Residential Care Homes Appareil pour Maison de santé et Maisons de retraite Aparato para Residencias de Ancianos y Asistencia de Ancianos Gerät für Alters- und Pflegeheime

**LED 24****alimentatore remoto/remote driver**

Per alimentare una o più lampade con tensione di sicurezza (SELV)

To power one or more lamps with safety voltage (SELV)

Pour alimenter une ou plusieurs lampes avec une tension de sécurité (SELV)

Para la alimentación de una o más lámparas con tensión de seguridad (SELV)

Versorgung einer oder mehrerer Leuchten mit Sicherheitskleinspannung (SELV)

**senza alimentatore incorporato
collegamento delle lampade in parallelo**

- without driver inside
lamp wiring in parallel
- sans ballast intégré
alimentation en parallèle
- sin transformador incorporado
conectar en paralelo
- Ohne eingebautes Vorschaltgerät,
Parallelschaltung der Leuchten.

**è necessario collegare le lampade
ad un alimentatore elettronico 24V**

- need to connect the lamps
with an electronic driver 24V
- il est nécessaire connecter les lampes
à une ballast électronique 24V
- es necesario conectar las lámparas
a un balasto electrónico 24V
- Die Leuchten müssen an ein elektronisches
24V Vorschaltgerät angeschlossen werden

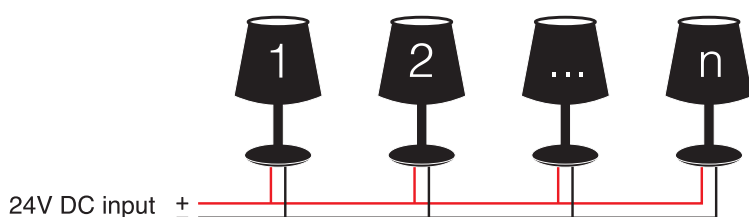
**numero max apparecchi collegabili /max connectable devices**

ARTICOLO/ITEM

alimentatore 60W/24V
 dims. 254x45x35 mm
cod. 90060
alimentatore 100W/24V
 dims. 270x63x41 mm
cod. 90061
alimentatore 150W/24V
 dims. 270x63x41 mm
cod. 90062

ARTICOLO/ITEM	alimentatore 60W/24V dims. 254x45x35 mm cod. 90060	alimentatore 100W/24V dims. 270x63x41 mm cod. 90061	alimentatore 150W/24V dims. 270x63x41 mm cod. 90062
ASTRA 250 LED24	7	12	18
ASTRA 300 LED24	5	9	14
ASTRA 360 LED24	5	9	14
BOLLA 260 LED24	7	12	18
BOLLA 310 LED24	5	9	14
BOLLA 370 LED24	5	9	14
DISCO 260 LED24	7	12	18
DISCO 310 LED24	5	9	14
GAMMA 250 LED24	7	12	18
GAMMA 350 LED24	5	9	14
MEGA 250 LED24	7	12	18
MEGA 350 LED24	5	9	14
QUADRO 250 LED24	7	12	18
QUADRO 300 LED24	5	9	14
TAB LED24	4	6	10
TAB1 LED24	4	6	10



DM dimmerabile/dimmerable

Per gestire un lampada

To control a lamp

Pour contrôler une lampe

Para controlar una lámpara

Leuchtensteuerung

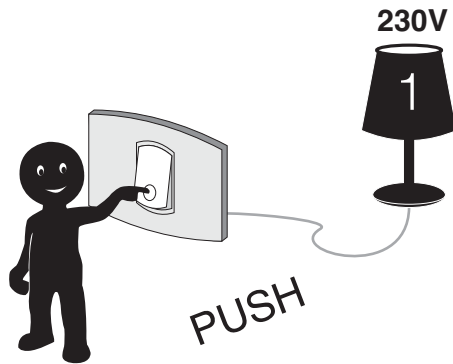

- **gestione manuale della lampada (accendi, regola, spegni)**
- manual working system (switch on, regulation, switch off)
- système de gestion manuelle (mise en marche, régler, arrêter)
- gestión manual del aparato (encender, ajustar, desactivar)
- Leuchtensteuerung von Hand (ein- und ausschalten, regulieren)

DM dimmerabile/dimmerable

Per variare in sincronia da due a dieci lampade

To control in synchrony from two to ten lamps

Pour contrôler la synchronisation de deux à dix lampes

Para controlar en sincronización de dos a diez lámparas

Synchronsteuerung von einer bis zehn Leuchten

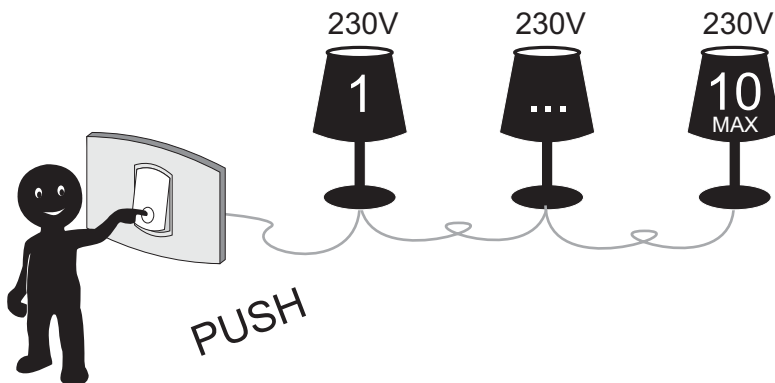

- **gestione manuale del sistema (accendi, regola, spegni) adatto anche per la gestione di più apparecchi**
 - manual working system (switch on, regulation, switch off) suitable also for multiple devices
 - système de gestion manuelle (mise en marche, régler, arrêter) adapté pour la gestion de plusieurs lampes
 - gestión manual del sistema (encender, ajustar, desactivar) también es adecuado para la gestión de más aparatos
 - Handsteuerung der Anlage (ein- und ausschalten, regulieren), auch zur Steuerung mehrerer Leuchten geeignet
- **é necessario collegare le lampade tra loro (max 10) con due cavi di sincronizzazione**
 - you need to connect the lamps to each other (max 10) with two sync cables
 - vous devez vous connecter les lampes à l'autre (max 10) avec deux câbles de synchronisation
 - es necesario conectar las lámparas entre sí (max 10) con dos cables de sincronización
 - Die Leuchten müssen untereinander mit zwei Synchronisationskabeln (maximal 10) verbunden werden

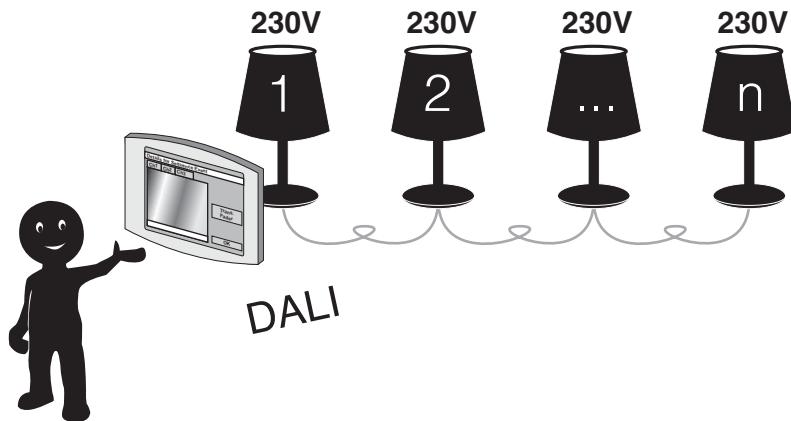
**DM**
dimmerabile/dimmerable**Per creare scenari con più lampade***To create different scenes with more lamps**Pour créer scènes différentes avec plusieurs lampes**Para crear diferentes escenas con múltiples lámparas**Lichtszenerien mit mehreren Leuchten erstellen***• gestione completa e personalizzabile del sistema adatto per grandi impianti ed effetti scenografici**

- full & customizable operation suitable for extender plant and scene effects
- gestion complet et personnalisable pour les grandes installations et effets scéniques
- gestión completa y personalizable para grandes instalaciones y efectos escénicos
- Vollständige und kundenspezifische Steuerung der Anlage, geeignet für große Anlagen und besondere Lichteffekte

• è necessario collegare le lampade tra loro con due cavi di sincronizzazione

- you need to connect the lamps to each other with two sync cables
- vous devez vous connecter les lampes à l'autre avec deux câbles de synchronisation
- es necesario conectar las lámparas entre sí con dos cables de sincronización
- Die Leuchten müssen untereinander mit zwei Synchronisationskabeln verbunden werden

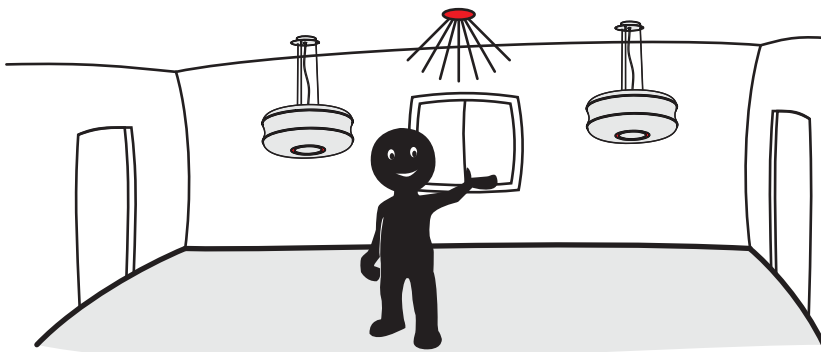
DM
opzioni a richiesta/option on request**Per controllare le lampade in base a specifiche situazioni ambientali***To control the lamps based on specific environmental situations**Pour commander les lampes en fonction des situations environnementales spécifiques**Para controlar las lámparas según situaciones ambientales específicas**Leuchtensteuerung nach spezifischen Umgebungsbedingungen***• DM opzioni a richiesta: sensore per abilitare la funzione corridor, sensore radar per rilevamento presenza**

- DM option on request: sensor to enable corridor function radar sensor for presence detection
- Options de DM sur demande: capteur pour activer la fonction corridor capteur radar pour la détection de la présence
- DM opciones bajo pedido: sensor para activar la función corridor sensor de radar para detectar la presencia
- DM-Option auf Anfrage: Sensor zur Freigabe der Corridor-Funktion, Radarsensor zur Bewegungserfassung

• è necessario collegare le lampade tra loro con due cavi di sincronizzazione

- you need to connect the lamps to each other with two sync cables
- vous devez vous connecter les lampes à l'autre avec deux câbles de synchronisation
- es necesario conectar las lámparas entre sí con dos cables de sincronización
- Die Leuchten müssen untereinander mit zwei Synchronisationskabeln verbunden werden



RGB DIG

cambio colore/color changing

Per cambiare colore ad una lampada

To change color to a lamp

Pour modifier la couleur d'une lampe

Para cambiar el color de una lámpara

Farbe einer Leuchte ändern

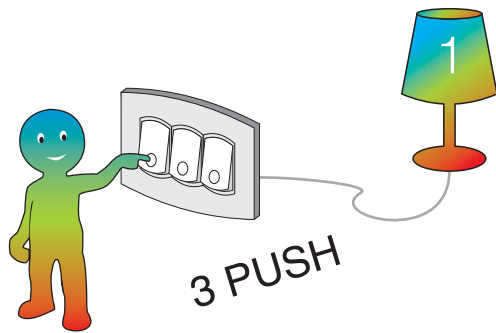

- gestione manuale della lampada (accendi, regola, spegni)
- manual working system (switch on, regulation, switch off)
- système de gestion manuelle (mise en marche, régler, arrêter)
- gestión manual del aparato (encender, ajustar, desactivar)
- Leuchtensteuerung von Hand (ein- und ausschalten, regulieren)

RGB DIG

cambio colore/color changing

Per cambiare colore in sincronia da due a dieci lampade

To control in synchrony from two to ten lamps

Pour contrôler la synchronisation de deux à dix lampes

Para controlar en sincronización de dos a diez lámparas

Synchronsteuerung von zwei bis zehn Leuchten

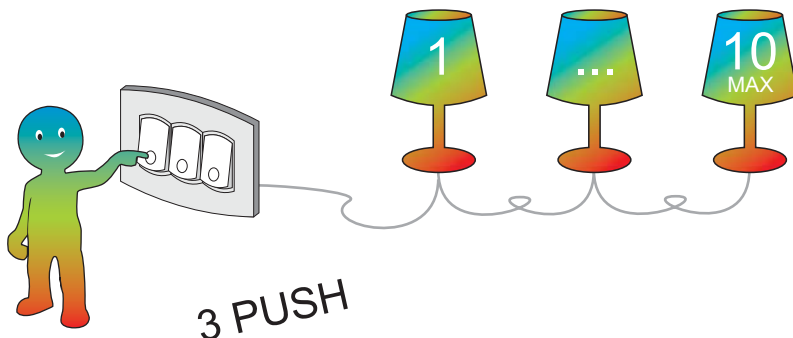

- gestione manuale del sistema (accendi, regola, spegni), adatto anche per la gestione di più lampade
 - manual working system (switch on, regulation, switch off) suitable also for multiple devices
 - système de gestion manuelle (mise en marche, régler, arrêter) adapté pour la gestion de plusieurs lampes
 - gestión manual del sistema (encender, ajustar, desactivar) también es adecuado para la gestión de más aparatos
 - Handsteuerung der Anlage (ein- und ausschalten, regulieren), auch zur Steuerung mehrerer Leuchten geeignet
- é necessario collegare le lampade tra loro (max 10) con due cavi di sincronizzazione
 - you need to connect the lamps to each other (max 10) with two sync cables
 - vous devez vous connecter les lampes à l'autre (max 10) avec deux câbles de synchronisation
 - es necesario conectar las lámparas entre sí (max 10) con dos cables de sincronización
 - Die Leuchten müssen untereinander mit zwei Synchronisationskabeln (maximal 10) verbunden werden



RGB DALI cambio colore/color changing

Per creare scenari di colore con più lampade

To create different color scenes with more lamps

Pour créer scènes des couleurs différentes avec plusieurs lampes

Para crear diferentes escenas des colores con múltiples lámparas

Lichtszenerien mit mehreren Leuchten erstellen

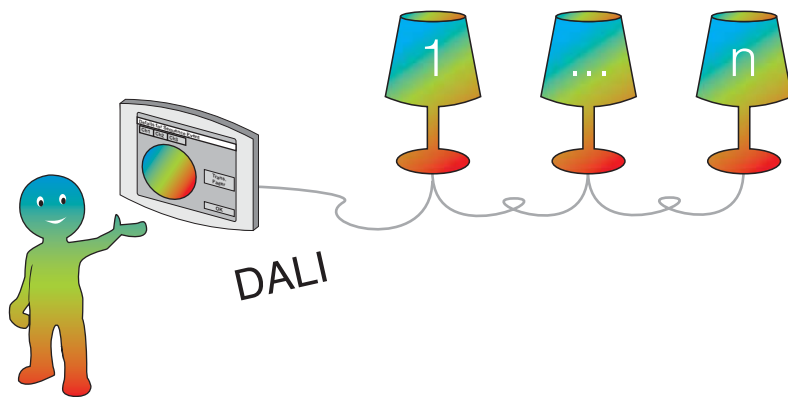

• gestione completa e personalizzabile del sistema, adatto per grandi impianti ed effetti scenografici

- full & customizable operation suitable for extender plant and scene effects
- gestion complet et personnalisable pour les grandes installations et effets scéniques
- gestión completa y personalizable para grandes instalaciones y efectos escénicos
- Vollständige und kundenspezifische Steuerung der Anlage, geeignet für große Anlagen und besondere Lichteffekte

• è necessario collegare le lampade tra loro con due cavi di sincronizzazione

- you need to connect the lamps to each other with two sync cables
- vous devez vous connecter les lampes à l'autre avec deux câbles de synchronisation
- es necesario conectar las lámparas entre sí con dos cables de sincronización
- Die Leuchten müssen untereinander mit zwei Synchronisationskabeln verbunden werden

Applique interni/esterni - Wall lights indoor/outdoor



Tab Led 18



Tab 1 Led 22



Tab 2 28



Tab Maxi 30



Forma 32



Ovetto 54



Pagoda 56



Kyo AP 58



Asia AP 60



Chrome 62



Dado Plissé 64



Vip 76



Vela 78



Sirya 80



Trilyum AP 82



Spicchio 84



Pallino 86



Tegola 98



Domo 100



Equos 102



Rol 108



Plan 110



Biplan 114



Nano APS 130



Ark 10 Led 132



Ark 20 Led 132

















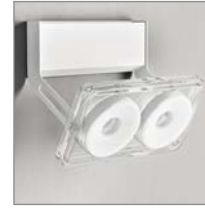













Kit 1 136



Kit 2 136



Cover 140

 Split 34	 Duo AP 42	 Ergo 60 46	 Ti-light AP 48	 Flash 50	 Vog 52
 Dado 64	 Retrò AP 66	 Segno 68	 Gina 70	 Lollo 72	 Aurora 74
 Omega AP 88	 Mega 1 90	 Mega 2 90	 Opera 92	 Girotondo AP 94	 Goccia 96
 Blik 116	 Star C 120	 Star L 124	 Step 1 126	 Step 2 126	 Step 3 126
 Band 142	 Kros 144	 Asso 146	 Polo 148	 Riga 148	

NEW Nuovo prodotto New product

Led Versione LED LED version

 Versione RGB RGB version

Gx24d/Gx24q TC-T/TC-TE		2G11 TC-L/TC-LE		R7s QT-DE 12 HDG	Rx7s HIT-DE MD	G12 HIT-CE MT		LED	RGB	EMERGENZA EMERGENCY	PAG./PAGE	ARTICOLO/ITEM
1 X	2 X	1 X	2 X	1 X	1 X	1 X	2 X					
								8/14/16			132	ARK 10 LED
								16,5/22,5/33			132	ARK 20 LED
								8,3			60	ASIA AP
								12,6			146	ASSO
								12,4/23		○	74	AURORA
								15,3			142	BAND
			3x18					34,5/68,7			114	BIPLAN
26	26/32/42		36/55					12,4...91,6		○	116	BLIK
											62	CHROME
								15,3		○	140	COVER
											64	DADO
											64	DADO PLISSÉ
	26/32/42				70/150			23/46		○	100	DOMO
								25...68,8		○	42	DUO AP
26/32/42	26/32/42					35/70/150		6/16,5		○	102	EQUOS 1
						35/70/150	35/70/150	12/33/22,5		○	102	EQUOS 2
								16,4			46	ERGO 60
								14,2			50	FLASH AP
								23			32	FORMA
								17			70	GINA
								12,4			94	GIROTONDO
								12,4			96	GOCCIA
26								12,6			136	KIT 1 - KIT 2
								15,3			144	KROS
								9,3			58	KYO
								17			72	LOLLO
								6,2			90	MEGA 1
								8,3			90	MEGA 2
								5,6			130	NANO APS
								6,2			88	OMEGA AP
								15,5		○	92	OPERA
								8,3/15,3			54	OVETTO
								13,2			56	PAGODA
								8,3			86	PALLINO
26	26/32/42		36/55					12,4...91,6		○	110	PLAN
								13,5			148	POLO
											66	RETRÒ AP
								13,5			148	RIGA
								9,3/18,6			108	ROL
											68	SEGNO
								8,6/15,8		○	80	SIRYA
								12,4			84	SPICCHIO
26	26/32/42		24/39/54/80					6,2...57,3		○	34	SPLIT
	26/32/42		36/55					12,4...91,6		○	120	STAR C
	26/32/42		36/55					23...91,6		○	124	STAR L
								6,3			126	STEP 1-2-3
								14,7		○	18	TAB LED
								14,7		○	22	TAB1 LED
									28		26	TAB RGB
								20			28	TAB 2
								14,7		○	30	TAB MAXI
		24/55	24/55					23/45,8		○	98	TEGOLA
					160						48	TI-LIGHT
								12,4			82	TRILYUM AP
								12,4		○	78	VELA
	26/32/42							12,4/23		○	76	VIP
								12			52	VOG AP

○ DISPONIBILE - AVAILABLE - DISPONIBLE - DISPONIBLE - VERFÜGBAR

14 applique interni/esterni
wall lights indoor/outdoor

150 plafoniere interni/esterni
ceiling bowls indoor/outdoor

248 testaletto
bed head units

258 sospensioni
suspensions

344 lampade
lamps

384 lampioni ed incassi
bollards & recessed lights

450 indice
index



Tab Led

Lampada da parete o soffitto. Tab è IP65 e può essere installato anche all'esterno. Base in policarbonato colore anice che permette di creare, sulla parete, un alone di luce diffusa. Diffusore in policarbonato trasparente, con pellicola di policarbonato opale inserita internamente. Anello esterno in policarbonato anice o con finitura alluminio ral 9006, nero opaco ral 9005 o cromato. Equipaggiata con led smd e alimentatore elettronico incorporato. Predisposto per il collegamento di un cavo di ingresso (alimentazione della rete) e quattro cavi di uscita (alimentazione degli apparecchi a "cascata" in parallelo).

Versioni LED24 per installazione in zona 1 (in prossimità di vasche o docce CEI 64-8/7 art.701.32) funzionanti con alimentatore remoto 24V non incluso e acquistabile separatamente.

Wall or ceiling lamp. Tab is IP65 rated and can even be installed outdoors. Base made in polycarbonate anis colour that permits to create, on the wall, a diffused light ring. Diffuser made in transparent polycarbonate with inside opal polycarbonate film. Ring made in polycarbonate anis colour or painted aluminium ral 9006, black matt ral 9005 or with chrome finish. Equipped with smd led and electronic driver included. Prepared with a device for connecting an input cable (mains supply) and four output cables (power to devices in "cascade" in parallel).

LED24 versions suitable for installation in zone 1 (near a bathtub or shower CEI 64-8/7 art.701.32) working with 24V remote ballast not included and purchasable separately.

Lampe à mur ou à plafond. Tab propose un indice IP65 et peut être installée à l'extérieur. Base en polycarbonate anis permet de créer, sur le mur, un halo de lumière diffuse. Diffuseur en polycarbonate transparente avec un film de polycarbonate opale à l'intérieur. Anneau en polycarbonate anis ou verni aluminium ral 9006, noire opaque ral 9005 ou avec finition chromé. Equipée avec led smd et ballast électronique incorporé. Préparé avec un dispositif permettant de connecter un câble d'entrée (alimentation secteur) et de quatre câbles de sortie (puissance aux dispositifs de la "cascade" en parallèle).

Versions LED24 pour installation in zone 1 (près d'une baignoire ou d'une douche CEI 64-8/7 art.701.32) fonctionnant avec ballast 24V à distance pas inclus et vendu séparément.



Lámpara de pared o de techo. Tab es IP65 y también se puede instalar en el exterior. La base de policarbonato de color anís permite crear, en la pared, un halo de luz. Difusor de policarbonato transparente, con una película interna de policarbonato opale. Anillo de policarbonato de color anís o colores aluminio ral 9006, negro opaco ral 9005 o cromado. Suministrada con led smd y alimentador electrónico incluido. Suministrado con un dispositivo para conectar un cable de entrada (red eléctrica) y cuatro cables de salida (energía a los dispositivos en "cascada" en paralelo).

Versiones LED24 para el uso en zona 1 (en las proximidades de las duchas o bañera CEI 64-8/7 art.701.32) usando alimentador 24V a distancia no incluido y que se vende separado.

Wand- und Deckenleuchte. Tab ist IP65 und kann auch im Freien installiert werden. Die Basis aus anisfarbenem Polycarbonat ermöglicht es, an der Wand einen Lichthof. Diffusor aus transparentem Polycarbonat mit einer innen Opal Polycarbonatfilm. Ring aus anisfarbenem Polycarbonat, Farbe Aluminium Ral 9006, Farbe mattschwarz Ral 9005 oder verchromtem. Ausgestattet mit LED smd. Eingebautem elektronischem Versorgungsgerät. Ausgestattet mit einer Vorrichtung zum Anschließen einer Eingangsspannung Kabel (Netz) und vier Output-Kabel (Stromversorgung von Geräten in "Kaskade" parallel).

LED24 Versionen für den Einsatz in Zone 1 (Nähe Badewanne oder Duschen CEI 64-8/7 art.701.32) mit 24V Fernspeisung nicht inbegriffen und separat erhältlich.



Tab Led

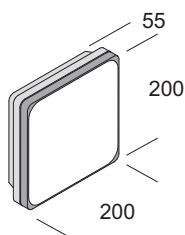

Articolo <i>Item</i>	Colore cornice <i>Ring color</i>				W _{max}	led	LUMEN	IP65	LUMEN/W	A	
	AN	AL	NE	CR							
	Codice <i>Code</i>										
● Led tab led-W	36621	36626	36627	36620	14,7	led	2190	IP65	□	149	A
● Led 24 tab led24-W	36631	36636	36637	36630	14,7	led	2190	IP65	◊	149	A
● LedDIG tab DIG led-W	36641	36646	36647	36640	14,7	led	2190	IP65	□	149	A
● LedDALI tab DALI led-W	36651	36656	36657	36650	14,7	led	2190	IP65	□	149	A
● Led EM tab EM led-W	30441	30446	30447	30440	14,7	led	2190	IP65	□	149	A
● Led tab led-N	36661	36666	36667	36660	14,7	led	2190	IP65	□	149	A
● Led 24 tab led24-N	36671	36676	36677	36670	14,7	led	2190	IP65	◊	149	A
● LedDIG tab DIG led-N	36681	36686	36687	36680	14,7	led	2190	IP65	□	149	A
● LedDALI tab DALI led-N	36691	36696	36697	36690	14,7	led	2190	IP65	□	149	A
● Led EM tab EM led-N	30451	30456	30457	30450	14,7	led	2190	IP65	□	149	A

Colore cornice *Ring color*

● Nuova versione *New version*

AN Anice <i>Anise</i>	AL RAL 9006 Alluminio <i>Aluminium</i>	NE RAL 9005 Nero opaco <i>Matt black</i>	CR Cromato <i>Chrome</i>
---------------------------------	---	---	------------------------------------

- Led** Equipaggiata con led 3000K - *Equipped with led 3000K*
- Led** Equipaggiata con led 4000K - *Equipped with led 4000K*
- Led 24** **Led 24** Installazione in zona 1 (in prossimità di vasche o docce CEI 64-8/7 art.701.32) con alimentatore remoto 24V non incluso e acquistabile separatamente (info pag. 9)
Installation in zone 1 (near a bathtub or shower CEI 64-8/7 art.701.32) with 24V remote ballast not included and purchasable separately (info page 9)
- LedDIG** **LedDIG** Dimmerabile PUSH/Dimmable *PUSH (info page10)*
- LedDALI** **LedDALI** Dimmerabile DALI/Dimmable *DALI (info page10)*
- Led EM** **Led EM** Emergenza (SA) 1h di serie – 3h a richiesta
Emergency 1h standard – 3h on request

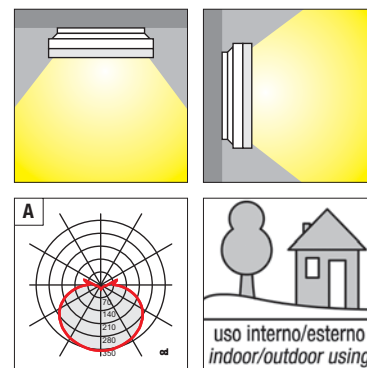



Tab1 Led *Incasso-Recessed*

Tab1 si installa ad incasso nelle pareti e nei controsoffitti. Tab1 è IP65 e può essere installato anche all'esterno. La cassaforma è acquistabile separatamente. Predisposto per il collegamento di un cavo di ingresso (alimentazione della rete) e quattro cavi di uscita (alimentazione degli apparecchi a "cascata" in parallelo).

Versioni LED24 per installazione in zona 1 (in prossimità di vasche o docce CEI 64-8/7 art.701.32) funzionanti con alimentatore remoto 24V non incluso e acquistabile separatamente.

Tab1 must be installed as recessed lamp in the wall and in the ceiling. Tab1 is IP65 rated and can even be installed outdoors. Recessing box is purchasable separately. Prepared with a device for connecting an input cable (mains supply) and four output cables (power to devices in "cascade" in parallel).

LED24 versions suitable for installation in zone 1 (near a bathtub or shower CEI 64-8/7 art.701.32) working with 24V remote ballast not included and purchasable separately.

Tab1 est encastrable dans le mur et dans le plafond. Tab1 propose un indice IP65 et peut être aussi installée à l'extérieur. Boîtier d'encastrement est vendu séparément. Préparé avec un dispositif permettant de connecter un câble d'entrée (alimentation secteur) et de quatre câbles de sortie (puissance aux dispositifs de la "cascade" en parallèle).

Versions LED24 pour installation in zone 1 (près d'une baignoire ou d'une douche CEI 64-8/7 art.701.32) fonctionnant avec ballast 24V à distance pas inclus et vendu séparément.

Tab1 se installa empotrada en la pared y en el techo. Tab1 es IP65 y también se puede instalar en el exterior. Caja de empotrar se vende separado. Suministrado con un dispositivo para conectar un cable de entrada (red eléctrica) y cuatro cables de salida (energía a los dispositivos en "cascada" en paralelo).

Versiones LED24 para el uso en zona 1 (en las proximidades de las duchas o bañera CEI 64-8/7 art.701.32) usando alimentador 24V a distancia no incluido y que se vende separado.

Tab1 kann installiert Einbau in der Wand und in der Decken. Tab1 ist IP65 und kann auch im Freien installiert werden. Schalung separat erhältlich. Ausgestattet mit einer Vorrichtung zum Anschließen einer Eingangsspannung Kabel (Netz) und vier Output-Kabel (Stromversorgung von Geräten in "Kaskade" parallel).

LED24 Versionen für den Einsatz in Zone 1 (Nähe Badewanne oder Duschen CEI 64-8/7 art.701.32) mit 24V Fernspeisung nicht inbegriffen und separat erhältlich.

Tab1 Led

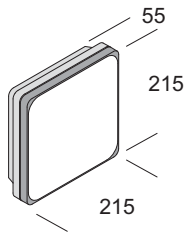

Articolo <i>Item</i>	Colore cornice <i>Ring color</i>				W _{max}	Icona	LUMEN	Icona	LUMEN/W	Icona	
	AN	AL	NE	CR							
	Codice <i>Code</i>										
● Led tab1 led-W	36701	36706	36707	36700	14,7	led	2190	IP65	□	149	A
● Led 24 tab1 led24-W	36711	36716	36717	36710	14,7	led	2190	IP65	◊	149	A
● LedDIG tab1 DIG led-W	36721	36726	36727	36720	14,7	led	2190	IP65	□	149	A
● LedDALI tab1 DALI led-W	36731	36736	36737	36730	14,7	led	2190	IP65	□	149	A
● Led EM tab1 EM led-W	30461	30466	30467	30460	14,7	led	2190	IP65	□	149	A
● Led tab1 led-N	36741	36746	36747	36740	14,7	led	2190	IP65	□	149	A
● Led 24 tab1 led24-N	36751	36756	36757	36750	14,7	led	2190	IP65	◊	149	A
● LedDIG tab1 DIG led-N	36761	36766	36767	36760	14,7	led	2190	IP65	□	149	A
● LedDALI tab1 DALI led-N	36771	36776	36777	36770	14,7	led	2190	IP65	□	149	A
● Led EM tab1 EM led-N	30471	30476	30477	30470	14,7	led	2190	IP65	□	149	A

Cassaforma Tab1

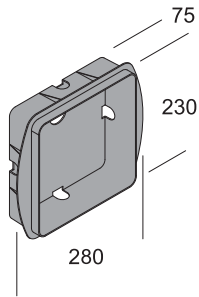

cassaforma tab1 30997 *cassaforma – recessing box*

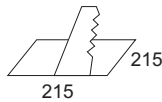

Installazione nel cartongesso
Installation for false-ceiling

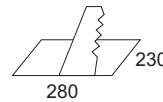

Installazione nel cemento
Installation for cement

Colore cornice *Ring color*

● Nuova versione *New version*

AN Anice <i>Anise</i>	AL RAL 9006 Alluminio <i>Aluminium</i>	NE RAL 9005 Nero opaco <i>Matt black</i>	CR Cromato <i>Chrome</i>
---------------------------------	--	--	------------------------------------

- Led Equipaggiata con led 3000K - *Equipped with led 3000K*
- Led Equipaggiata con led 4000K - *Equipped with led 4000K*
- Led 24 ● Led 24 Installazione in zona 1 (in prossimità di vasche o docce CEI 64-8/7 art.701.32) con alimentatore remoto 24V non incluso e acquistabile separatamente (info pag. 9)
Installation in zone 1 (near a bathtub or shower CEI 64-8/7 art.701.32) with 24V remote ballast not included and purchasable separately (info page 9)
- LedDIG ● LedDIG Dimmerabile PUSH/*Dimmable PUSH (info page10)*
- LedDALI ● LedDALI Dimmerabile DALI/*Dimmable DALI (info page10)*
- Led EM ● Led EM Emergenza (SA) 1h di serie – 3h a richiesta
Emergency 1h standard – 3h on request

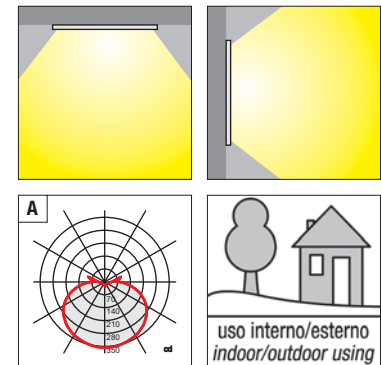





Tab e Tab1 possono essere personalizzati, a richiesta, con un logo o con un'immagine. Il costo supplementare sarà preventivato per ogni realizzazione.

Tab and Tab1 can be personalized with a logo or an image. The additional cost will be estimated for each project.

Tab et Tab1 peu être personnalisé avec un logo ou une image. Le coût supplémentaire sera prévu pour chaque projet.

Tab e Tab1 se puede personalizar con un logotipo o una imagen. El costo adicional se calculará para cada proyecto.

Tab und Tab1 können mit einem Logo oder ein Bild angefertigt werden. Die zusätzlichen Kosten werden für jedes Projekt berechnet werden.



Tab RGB - Tab1 RGB

Lampada da parete o soffitto installabile anche all'esterno. Sistema RGB per missaggio di luci colorate equipaggiato con LED smd Full Color, alimentatore elettronico incorporato con modulo per controllo ciclo colore.

Wall or ceiling lamp can even be installed outdoors. RGB system for coloured lights mixing equipped with LED smd Full Color, electronic gear included to control colour cycle.

Lampe à mur ou à plafond peut être aussi installée à l'extérieur. System RGB pour mixage de lumières colorées est équipée avec LED smd Full Color, ballast électronique incorporé pour contrôler le cycle des couleurs.

Lámpara de pared o de techo se puede instalar en el exterior. Sistema RGB para mezclar las luces coloreadas suministrado con LED smd Full Color, alimentador electrónico incorporado con módulo para el control del ciclo de color.

Wand- und Deckenleuchte kann im Freien installiert werden. RGB System zur Mischung bunter Lichter Ausführung zum LED smd Full Color, elektronisches Versorgungsgerät mit Modul zur Farbzykluskontrolle integriert.

Tab RGB

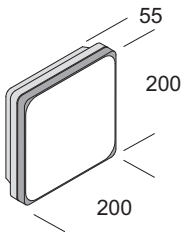

Articolo Item	Colore cornice Ring color				W _{max}	LED	LUMEN	IP	Icona	LUMEN/W	Icona
	AN	AL	NE	CR							
		Codice Code									
DIG tab RGB DIG	30341	30346	30347	30340	28	led	1680	IP65	□	60	(nd)
DALI tab RGB DALI	30351	30356	30357	30350	28	led	1680	IP65	□	60	(nd)

Tab1 RGB

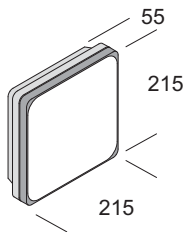

DIG tab1 RGB DIG	30361	30366	30367	30360	28	led	1680	IP65	□	60	(nd)
DALI tab1 RGB DALI	30371	30376	30377	30370	28	led	1680	IP65	□	60	(nd)

Cassaforma Tab1

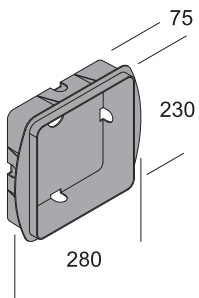

cassaforma tab1 30997 cassaforma – recessing box

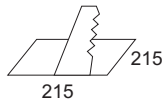

Installazione nel cartongesso
Installation for false-ceiling

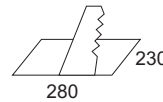

Installazione nel cemento
Installation for cement

Colore cornice Ring color

AN Anice Anise	AL RAL 9006 Alluminio Aluminium	NE RAL 9005 Nero opaco Matt black	CR Cromato Chrome
--------------------------	---	---	-----------------------------

DIG **DALI** Informazioni tecniche
Technical instructions (info pag.12)

(nd) Non disponibile - Not available

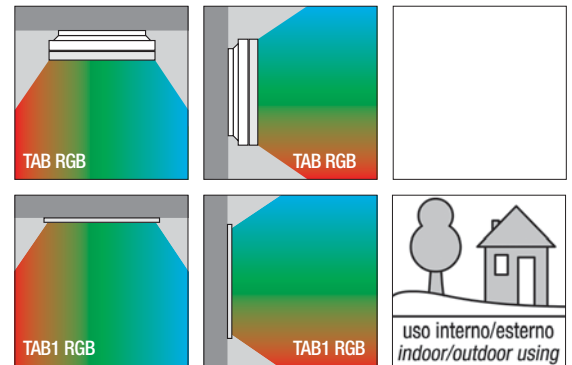



Tab2

Lampada da parete con flusso bi-emissione. Struttura in metallo verniciato. Diffusori in policarbonato trasparente, con pellicola di policarbonato opale inserita internamente. **Equipaggiata con led smd e alimentatore elettronico incorporato.**

Wall lamp with bi-emission light flux. Structure made in chrome plated or painted metal. Diffusers made in transparent polycarbonate with inside opal polycarbonate film. **Equipped with smd led and electronic driver included.**

Lampe à mur avec flux bi-émission de lumière. Structure réalisée en métal chromé ou verni. Diffuseurs en polycarbonate transparente avec un film de polycarbonate opale à l'intérieur. **Equipée avec led smd et ballast électronique incorporé.**

Lámpara de pared con flujo bi-emisión de luz. Estructura en metal cromado o pintado. Difusores de policarbonato transparente, con una película interna de policarbonato opale. **Suministrada con led smd y alimentador electrónico incluido.**

Wandleuchte mit dual-emission Licht. Struktur aus verchromtem Metall oder lackiertem Metall. Diffusoren aus transparentem Polycarbonat mit eine innen Opal Polycarbonatfilm. **Ausgestattet mit LED smd. Eingebautem elektronischem Versorgungsgerät.**

Tab2

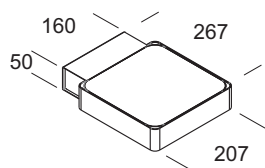

Colore struttura Structure color

Articolo Item	Colore struttura Structure color		W _{max}	Icona	LUMEN	Icona	LUMEN/W	Icona
	AL	BI						
	Codice Code							
Led tab2 led-W	36886	36881	20	led	2600	IP40	150	A
LedDIG tab2 DIG led-W	36906	36901	20	led	2600	IP40	150	A
LedDALI tab2 DALI led-W	36926	36921	20	led	2600	IP40	150	A
Led tab2 led-N	36896	36891	20	led	2600	IP40	150	A
LedDIG tab2 DIG led-N	36916	36911	20	led	2600	IP40	150	A
LedDALI tab2 DALI led-N	36936	36931	20	led	2600	IP40	150	A



Colore struttura Structure color

AL RAL 9006
Alluminio Aluminium

BI RAL 9016
Bianco opaco Matt white

- Led Equipaggiata con led 3000K - Equipped with led 3000K
- Led Equipaggiata con led 4000K - Equipped with led 4000K
- LedDIG LedDIG Dimmerabile PUSH/Dimmable PUSH (info page10)
- LedDALI LedDALI Dimmerabile DALI/Dimmable DALI (info page10)

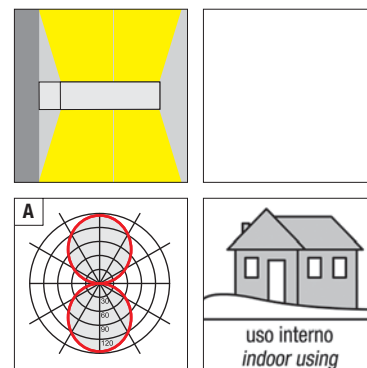



Tab Maxi

Lampada da parete o soffitto. Base in policarbonato colore anice che permette di creare, sulla parete, un alone di luce diffusa. Diffusore in policarbonato trasparente, con pellicola di policarbonato opale inserita internamente. Cornice in metallo verniciato. **Equipaggiata con led smd e alimentatore elettronico incorporato.** Predisposto per il collegamento di un cavo di ingresso (alimentazione della rete) e quattro cavi di uscita (alimentazione degli apparecchi a "cascata" in parallelo).

Wall or ceiling lamp. Base made in polycarbonate anis colour that permits to create, on the wall, a diffused light ring. Diffuser made in transparent polycarbonate with inside opal polycarbonate film. Frame made in painted metal. **Equipped with smd led and electronic driver included.** Prepared with a device for connecting an input cable (mains supply) and four output cables (power to devices in "cascade" in parallel).

Lampe à mur ou à plafond. Base en polycarbonate anis permet de créer, sur le mur, un halo de lumière diffuse. Diffuseur en polycarbonate transparente avec un film de polycarbonate opale à l'intérieur. Cadre en métal verni. **Equipée avec led smd et ballast électronique incorporé.** Préparé avec un dispositif permettant de connecter un câble d'entrée (alimentation secteur) et de quatre câbles de sortie (puissance aux dispositifs de la "cascade" en parallèle).

Lámpara de pared o de techo. La base de policarbonato de color anís permite crear, en la pared, un halo de luz. Difusor de policarbonato transparente, con una película interna de policarbonato opale. Marco de metal pintado. **Suministrada con led smd y alimentador electrónico incluido.** Suministrado con un dispositivo para conectar un cable de entrada (red eléctrica) y cuatro cables de salida (energía a los dispositivos en "cascada" en paralelo).

Wand- und Deckenleuchte. Die Basis aus anisfarbenem Polycarbonat ermöglicht es, an der Wand einen Lichthof. Diffusor aus transparentem Polycarbonat mit eine innen Opal Polycarbonatfilm. Ring aus lackiertem Metall. **Ausgestattet mit LED smd eingebautem elektronischem Versorgungsgerät.** Ausgestattet mit einer Vorrichtung zum Anschließen einer Eingangsspannung Kabel (Netz) und vier Output-Kabel (Stromversorgung von Geräten in "Kaskade" parallel).

Tab Maxi

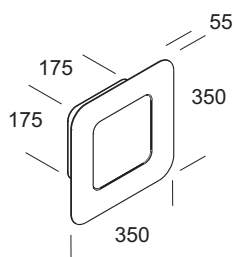

Articolo <i>Item</i>	Colore cornice <i>Frame color</i>				W _{max}		LUMEN		LUMEN/W		
	AR	BI	GI	TO							Codice <i>Code</i>
Led tab maxi led-W	34103	34101	34102	34108	14,7	led	2190	IP65		149	A
LedDIG tab maxi DIG led-W	34113	34111	34112	34118	14,7	led	2190	IP65		149	A
LedDALI tab maxi DALI led-W	34123	34121	34122	34128	14,7	led	2190	IP65		149	A
LedEM tab maxi EM led-W	30883	30881	30882	30888	14,7	led	2190	IP65		149	A
Led tab maxi led-N	34133	34131	34132	34138	14,7	led	2190	IP65		149	A
LedDIG tab maxi DIG led-N	34143	34141	34142	34148	14,7	led	2190	IP65		149	A
LedDALI tab maxi DALI led-N	34153	34151	34152	34158	14,7	led	2190	IP65		149	A
LedEM tab maxi EM led-N	30893	30891	30892	30898	14,7	led	2190	IP65		149	A



Colore cornice *Frame color*

AR RAL 2001 Arancio Rosso Opaco <i>Matt Red Orange</i>	BI RAL 9016 Bianco opaco <i>Matt white</i>	GI RAL 1028 Giallo Melone Opaco <i>Matt Melon Yellow</i>	TO RAL 1019 Tortora opaco <i>Matt grey beige</i>
--	---	--	--

- Led Equipaggiata con led 3000K - *Equipped with led 3000K*
- Led Equipaggiata con led 4000K - *Equipped with led 4000K*
- LedDIG LedDIG Dimmerabile PUSH/Dimmable PUSH (*info page10*)
- LedDALI LedDALI Dimmerabile DALI/Dimmable DALI (*info page10*)
- LedEM LedEM Emergenza (SA) 1h di serie – 3h a richiesta.
Emergency 1h standard – 3h on request

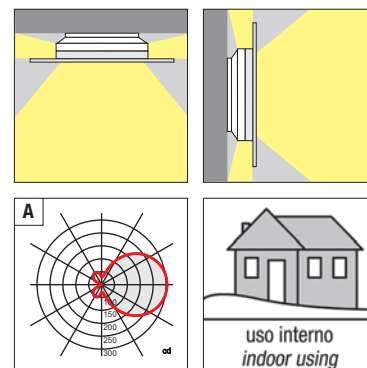



Forma

Lampada da parete. Struttura in alluminio estruso, cornice in acciaio verniciato. Diffusori in policarbonato colore anice. **Equipaggiata con led smd e alimentatore elettronico incorporato.**

Wall lamp. Structure made in extruded aluminium. Painted steel frame. Diffusers made in polycarbonate anise colour. **Equipped with smd led and electronic driver included.**

Lampe à mur. Structure réalisée en extrusion d'aluminium. Cadre en acier vernie. Diffuseurs en polycarbonate couleur anis. **Equipée avec led smd et ballast électronique incorporé.**

Lámpara de pared. Estructura de aluminio extrudido. Marco de acero pintado. Difusor de policarbonato color anís. **Suministrada con led smd y alimentador electrónico incluido.**

Wandleuchte. Struktur aus Aluminium extrusion und lackiertem Stahl. Diffusor aus anisfarbenem Polycarbonat. **Ausgestattet mit led smd eingebautem elektronischem Versorgungsgerät.**

Forma

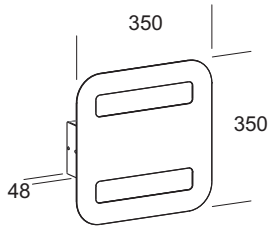

Articolo Item	Colore cornice Frame color				W _{max}	LUMEN	LUMEN/W	A
	AR	BI	GI	TO				
	Codice Code							
Led forma-W	34263	34261	34262	34268	23	led 3120 IP40	⊕	136
Led forma-N	34273	34271	34272	34278	23	led 3120 IP40	⊕	136



Colore cornice Frame color

AR RAL 2001 Arancio Rosso Opaco <i>Matt Red Orange</i>	BI RAL 9016 Bianco opaco <i>Matt white</i>	GI RAL 1028 Giallo Melone Opaco <i>Matt Melon Yellow</i>	TO RAL 1019 Tortora opaco <i>Matt grey beige</i>
--	--	--	--

- Led Equipaggiata con led 3000K - *Equipped with led 3000K*
- Led Equipaggiata con led 4000K - *Equipped with led 4000K*

14 applique interni/esterni
wall lights indoor/outdoor

150 plafoniere interni/esterni
ceiling bowls indoor/outdoor

248 testataletto
bed head units

258 sospensioni
suspensions

344 lampade
lamps

384 lampioni ed incassi
bollards & recessed lights

450 indice
index

Split

Lampada da parete e da soffitto per illuminazione di ambienti con luce diffusa. Il diffusore ruota di 360° permettendo di orientare il fascio luminoso. Diffusore in policarbonato colore anice. Struttura in alluminio estruso. Particolari in policarbonato trasparente.

Versione LED equipaggiata con led smd. Tutte le lampade hanno l'alimentatore elettronico incorporato.

Wall and ceiling lamp to illuminate with diffused light. The diffuser rotates on 360 degree permitting to orientate the luminous beam. Diffuser made in polycarbonate anise colour. Structure made in extruded aluminium. Details made in transparent polycarbonate. **LED version equipped with smd led. All fittings have electronic driver included.**

Lampe à mur et à plafond pour éclairage avec lumière diffuse. Le diffuseur tourne de 360 degré permettant d'orienter le flux lumineux. Diffuseur en polycarbonate couleur anis. Structure réalisée en extrusion d'aluminium. Détails en polycarbonate transparent.

Version LED équipée avec led smd. Toutes les versions sont avec ballast électronique incorporé.

Lámpara de pared y de techo para iluminación de ambientes con luz difusa. El difusor gira en 360° permitiendo orientar el rayo luminoso. Difusor de policarbonato color anís. Estructura de aluminio extrudido. Detalles de policarbonato transparente.

Version LED suministrada con led smd. Todas las lámparas tienen alimentador electrónico incluido.

Wand- und Deckenleuchte zur Beleuchtung von Räumen mit diffusem Licht. Der Diffusor kann um 360° gedreht werden und ermöglicht auf diese Weise die Ausrichtung der Lichtstrahl. Diffusor aus anisfarbenem Polycarbonat. Struktur aus Aluminium Extrusion.

Ausführung RGB zum Mischen von farbigen Lichtern. Ausführung LED zum led smd. Alle Versionen mit integriert Versorgungsgerät elektronisch.



Disponibile in versione Dark Light e installabile in linea continua.

Available in Dark Light version and suitable for continuous-row lighting.

Disponibile en version Dark Light et installable en ligne continue.

Disponibile en version Dark Light y instalable en línea continua.

Version Dark Light verfügbar und die Ausführung ist in Lichtbandversion.



14 applique interni/esterni
wall lights indoor/outdoor

150 plafoniere interni/esterni
ceiling bowls indoor/outdoor

248 testaletto
bed head units

258 sospensioni
suspensions

344 lampade
lamps

384 lampioni ed incassi
bollards & recessed lights

450 indice
index

Colore struttura Structure color

Split 20

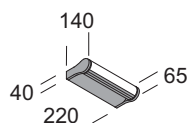

Articolo Item	Colore struttura Structure color		W _{max}	Lamp	LUMEN	IP	Beam	LUMEN/W	Icon
	CR	AL							
	Codice Code								
● Led split 20 led-W	36980	36986	6,2	led	850	IP44	⊕	137	D
● Led split 20 led-N	36990	36996	6,2	led	850	IP44	⊕	137	D
EL split 20/18 EL	39630	39636	1x18	G24q-2	1200	IP44	⊕	67	A

Split 60

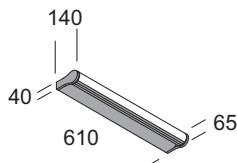

● Led split 60 led-W	35250	35256	12,5	led	1810	IP44	⊕	145	D
● split 60S led-W	35260	35266	22,9	led	3130	IP44	⊕	137	D
● Led DM split 60S DM led-W	35270	35276	22,9	led	3130	IP44	⊕	137	D
● Led EM split 60 EM led-W	30580	30586	12,5	led	1810	IP44	⊕	145	D
● split 60S EM led-W	30590	30596	22,9	led	3130	IP44	⊕	137	D
● Led split 60 led-N	35280	35286	12,5	led	1810	IP44	⊕	145	D
● split 60S led-N	35290	35296	22,9	led	3130	IP44	⊕	137	D
● Led DM split 60S DM led-N	35300	35306	22,9	led	3130	IP44	⊕	137	D
● Led EM split 60 EM led-N	30600	30606	12,5	led	1810	IP44	⊕	145	D
● split 60S EM led-N	30610	30616	22,9	led	3130	IP44	⊕	137	D
EL split 60/24 EL	39210	39216	1x24	G5	2000	IP44	⊕	83	B
split 60/2x24 EL	39250	39256	2x24	G5	4000	IP44	⊕	83	C
EM split 60/24 EM	30020	30026	1x24	G5	2000	IP44	⊕	83	B
split 60/2x24 EM	30220	30226	2x24	G5	4000	IP44	⊕	83	C

Colore struttura Structure color

● Nuova versione New version

CR
Alluminio brillantato (effetto cromato) Shined aluminium (chrome effect)

AL
Alluminio anodizzato Oxided aluminium

- Led** Equipaggiata con led 3000K - Equipped with led 3000K
- Led** Equipaggiata con led 4000K - Equipped with led 4000K
- Led DM** **Led DM** Dimmerabile PUSH/DALI
Dimmable PUSH/DALI (info page10)
- Led EM** **Led EM** **EM** Emergenza (SA) 1h di serie – 3h a richiesta
Emergency 1h standard – 3h on request

Dark Light Pag. 170

Pag. 290

360°

uso interno/esterno
indoor/outdoor using

Split 90

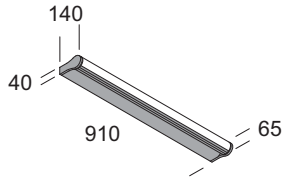

		Colore struttura Structure color		W _{max}	Icona	LUMEN	Icona	LUMEN/W	Icona	
Articolo Item		CR	AL							
		Codice Code								
●	Led split 90 led-W	35310	35316	18,7	led	2660	IP44	⊕	142	D
●	split 90S led-W	35320	35326	34,4	led	4690	IP44	⊕	136	D
●	Led DM split 90S DM led-W	35330	35336	34,4	led	4690	IP44	⊕	136	D
●	Led EM split 90 EM led-W	30620	30626	18,7	led	2660	IP44	⊕	142	D
●	split 90S EM led-W	30630	30636	34,4	led	4690	IP44	⊕	136	D
●	Led split 90 led-N	35340	35346	18,7	led	2660	IP44	⊕	142	D
●	split 90S led-N	35350	35356	34,4	led	4690	IP44	⊕	136	D
●	Led DM split 90S DM led-N	35360	35366	34,4	led	4690	IP44	⊕	136	D
●	Led EM split 90 EM led-N	30640	30646	18,7	led	2660	IP44	⊕	142	D
●	split 90S EM led-N	30650	30656	34,4	led	4690	IP44	⊕	136	D
	EL split 90/39 EL	39220	39226	1x39	G5	3500	IP44	⊕	90	B
	split 90/2x39 EL	39260	39266	2x39	G5	7000	IP44	⊕	90	C
	DM split 90/2x39 DM	39700	39706	2x39	G5	7000	IP44	⊕	90	C
	EM split 90/39 EM	30040	30046	1x39	G5	3500	IP44	⊕	90	B
	split 90/2x39 EM	30230	30236	2x39	G5	7000	IP44	⊕	90	C

Colore struttura Structure color

● Nuova versione New version

CR
Alluminio brillantato (effetto cromato) Shined aluminium (chrome effect)

AL
Alluminio anodizzato Oxided aluminium

Led Equipaggiata con led 3000K - Equipped with led 3000K

Led Equipaggiata con led 4000K - Equipped with led 4000K

Led DM **Led DM** **DM** Dimmerabile PUSH/DALI
Dimmable PUSH/DALI (info page10)

Led EM **Led EM** **EM** Emergenza (SA) 1h di serie – 3h a richiesta
Emergency 1h standard – 3h on request

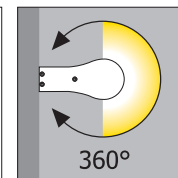
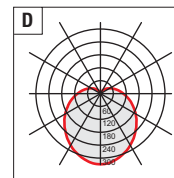
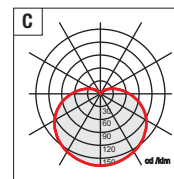
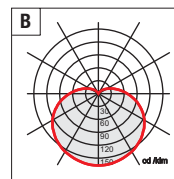

Colore struttura Structure color

Split 120

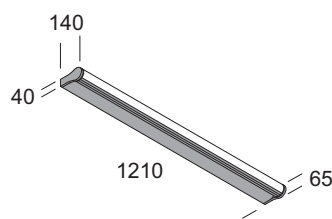

Articolo Item	Colore struttura Structure color		W _{max}	LUMEN	IP	LUMEN/W	Icon
	CR	AL					
	Codice Code						
● Led split 120 led-W	35370	35376	25	3620	IP44	145	D
● split 120S led-W	35380	35386	45,8	6260	IP44	137	D
● Led DM split 120S DM led-W	35390	35396	45,8	6260	IP44	137	D
● Led EM split 120 EM led-W	30660	30666	25	3620	IP44	145	D
● split 120S EM led-W	30670	30676	45,8	6260	IP44	137	D
● Led split 120 led-N	35400	35406	25	3620	IP44	145	D
● split 120S led-N	35410	35416	45,8	6260	IP44	137	D
● Led DM split 120S DM led-N	35420	35426	45,8	6260	IP44	137	D
● Led EM split 120 EM led-N	30680	30686	25	3620	IP44	145	D
● split 120S EM led-N	30690	30696	45,8	6260	IP44	137	D
EL split 120/54 EL	39230	39236	1x54	5000	IP44	93	B
split 120/2x54 EL	39270	39276	2x54	10000	IP44	93	C
DM split 120/2x54 DM	39710	39716	2x54	10000	IP44	93	C
EM split 120/54 EM	30050	30056	1x54	5000	IP44	93	B
split 120/2x54 EM	30240	30246	2x54	10000	IP44	93	C

Colore struttura Structure color

● Nuova versione New version

CR

Alluminio brillantato (effetto cromato) Shined aluminium (chrome effect)

AL

Alluminio anodizzato Oxided aluminium

- Led Equipaggiata con led 3000K - Equipped with led 3000K
- Led Equipaggiata con led 4000K - Equipped with led 4000K
- Led DM Led DM DM Dimmerabile PUSH/DALI
Dimmable PUSH/DALI (info page10)
- Led EM Led EM EM Emergenza (SA) 1h di serie – 3h a richiesta
Emergency 1h standard – 3h on request

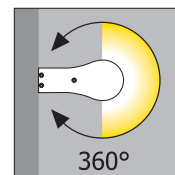
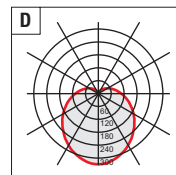
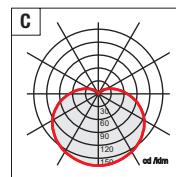
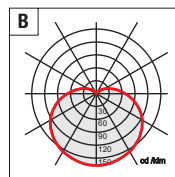

Split 150

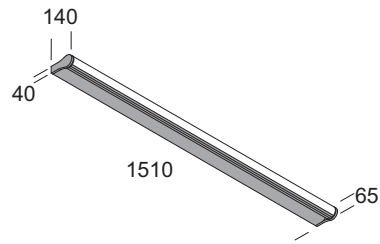

		Colore struttura Structure color		W _{max}	Icon	LUMEN	Icon	LUMEN/W	Icon	
Articolo Item		CR	AL							
		Codice Code								
●	Led	split 150 led-W	35430 35436	31,2	led	4470	IP44	⊕	143	D
●		split 150S led-W	35440 35446	57,3	led	7820	IP44	⊕	136	D
●	Led DM	split 150S DM led-W	35450 35456	57,3	led	7820	IP44	⊕	136	D
●	Led EM	split 150 EM led-W	30700 30706	31,2	led	4470	IP44	⊕	143	D
●		split 150S EM led-W	30710 30716	57,3	led	7820	IP44	⊕	136	D
●	Led	split 150 led-N	35460 35466	31,2	led	4470	IP44	⊕	143	D
●		split 150S led-N	35470 35476	57,3	led	7820	IP44	⊕	136	D
●	Led DM	split 150S DM led-N	35480 35486	57,3	led	7820	IP44	⊕	136	D
●	Led EM	split 150 EM led-N	30720 30726	31,2	led	4470	IP44	⊕	143	D
●		split 150S EM led-N	30730 30736	57,3	led	7820	IP44	⊕	136	D
	EL	split 150/80 EL	39240 39246	1x80	G5	7000	IP44	⊕	87	B
		split 150/2x80 EL	39280 39286	2x80	G5	14000	IP44	⊕	87	C
	DM	split 150/2x80 DM	39720 39726	2x80	G5	14000	IP44	⊕	87	C
	EM	split 150/80 EM	30060 30066	1x80	G5	7000	IP44	⊕	87	B
		split 150/2x80 EM	30250 30256	2x80	G5	14000	IP44	⊕	87	C

Colore struttura Structure color

● Nuova versione New version

CR
Alluminio brillantato (effetto cromato) *Shined aluminium (chrome effect)*

AL
Alluminio anodizzato *Oxided aluminium*

Led Equipaggiata con led 3000K - *Equipped with led 3000K*

Led Equipaggiata con led 4000K - *Equipped with led 4000K*

Led DM **Led DM** **DM** Dimmerabile PUSH/DALI
Dimmable PUSH/DALI (info page 10)

Led EM **Led EM** **EM** Emergenza (SA) 1h di serie – 3h a richiesta
Emergency 1h standard – 3h on request

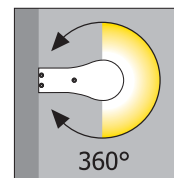
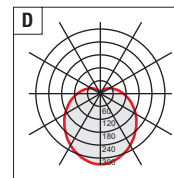
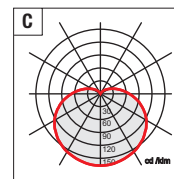
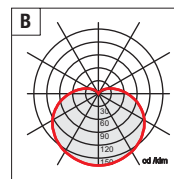

Colore struttura Structure color

Split 20 IN

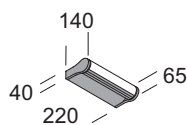

Fornito con interruttore basculante.
Equipped with rocker switch.

Articolo Item	Colore struttura Structure color		W _{max}	LUMEN	IP	LUMEN/W	Icon
	CR	AL					
● Led split 20 led-W IN	36940	36946	6,2	850	IP44	137	D
● Led split 20 led-N IN	36950	36956	6,2	850	IP44	137	D
EL split 20/18 IN	39620	39626	1x18	G24q-2	1200	IP44	67 A

Split 60 IN

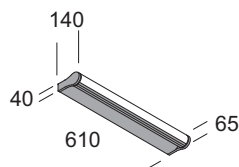

Fornito con interruttore basculante.
Equipped with rocker switch.

● Led split 60 led-W IN	36960	36966	12,5	1810	IP44	145	D
● Led split 60 led-N IN	36970	36976	12,5	1810	IP44	145	D
EL split 60/24 IN	39670	39676	1x24	G5	2000	IP44	83 B



Colore struttura Structure color

● Nuova versione New version

CR

Alluminio brillantato (effetto cromato) Shined aluminium (chrome effect)

AL

Alluminio anodizzato Oxided aluminium

● Led Equipaggiata con led 3000K - Equipped with led 3000K

● Led Equipaggiata con led 4000K - Equipped with led 4000K

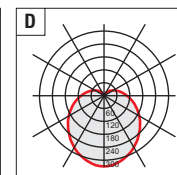
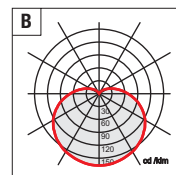
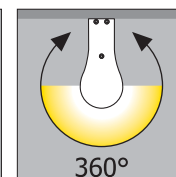
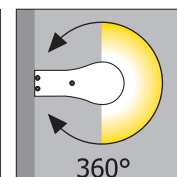
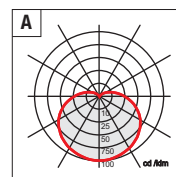



14 applique interni/esterni
wall lights indoor/outdoor

150 plafoniere interni/esterni
ceiling bowls indoor/outdoor

248 testaletto
bed head units

258 sospensioni
suspensions

344 lampade
lamps

384 lampioni ed incassi
bollards & recessed lights

450 indice
index

Duo AP

Lampada da parete e da soffitto per illuminazione di ambienti con luce diffusa. Il diffusore ruota di 360° permettendo di orientare il fascio luminoso. Diffusore in policarbonato colore anice. Struttura in alluminio estruso. Particolari in policarbonato trasparente. Le versioni con 4 lampade sono cablate per doppia accensione separata. **Versione LED equipaggiata con led smd. Tutte le lampade hanno l'alimentatore elettronico incorporato.**

Wall and ceiling lamp to illuminate with diffused light. The diffuser rotates on 360 degree permitting to orientate the luminous beam. Diffuser made in polycarbonate anise colour. Structure made in extruded aluminium. Details made in transparent polycarbonate. Versions cabled with 4 bulbs are equipped with double separate lighting. **LED version equipped with smd led. All fittings have electronic driver included.**

Lampe à mur et à plafond pour éclairage avec lumière diffuse. Le diffuseur tourne de 360 degré permettant d'orienter le flux lumineux. Diffuseur en polycarbonate couleur anis. Structure réalisée en extrusion d'aluminium. Détails en polycarbonate transparent. Les versions câblées avec 4 ampoules sont équipées avec allumage double séparée. **Version LED équipée avec led smd. Toutes les versions sont avec ballast électronique incorporé.**

Lámpara de pared y de techo para iluminación de ambientes con luz difusa. El difusor gira en 360° permitiendo orientar el rayo luminoso. Difusor de policarbonato color anís. Estructura de aluminio extrudido. Detalles de policarbonato transparente. Las versiones con 4 lámparas están cableadas para doble encendido separado. **Versión LED suministrada con led smd. Todas las lámparas tienen alimentador electrónico incluido.**

Wand- und Deckenleuchte zur Beleuchtung von Räumen mit diffusem Licht. Der Diffusor kann um 360° gedreht werden und ermöglicht auf diese Weise die Ausrichtung der Lichtstrahl. Diffusor aus anisfarbenem Polycarbonat. Struktur aus Aluminium Extrusion. Einzelteile aus transparentem Polycarbonat. Die Ausführungen mit 4 Lampen sind für das doppelte getrennte Einschalten verkabelt. **Ausführung LED zum led smd. Alle Versionen mit integriert Versorgungsgerät elektronisch.**



Disponibile in versione Dark Light e installabile in linea continua.

Available in Dark Light version and suitable for continuous-row lighting.

Disponibile en version Dark Light et installable en ligne continue.

Disponibile en version Dark Light y instalable en línea continua.

Versión Dark Light verfügbar und die Ausführung ist in Lichtbandversion.



14 applique interni/esterni
wall lights indoor/outdoor

150 plafoniere interni/esterni
ceiling bowls indoor/outdoor

248 testaletto
bed head units

258 sospensioni
suspensions

344 lampade
lamps

384 lampioni ed incassi
bollards & recessed lights

450 indice
index

Duo AP 60

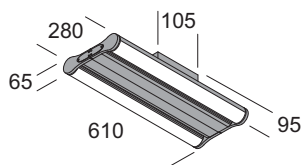

Articolo Item	Colore struttura Structure color		W _{max}	LUMEN	IP	LUMEN/W	Icon
	CR	AL					
	Codice Code						
● Led duo AP 60 led-W	35490	35496	25	led	3620	IP20	⊕ 145 C
● duo AP 60S led-W	35500	35506	45,8	led	6260	IP20	⊕ 137 C
● Led DM duo AP 60S DM led-W	35510	35516	45,8	led	6260	IP20	⊕ 137 C
● Led EM duo AP 60 EM led-W	30740	30746	25	led	3620	IP20	⊕ 145 C
● duo AP 60S EM led-W	30750	30756	45,8	led	6260	IP20	⊕ 137 C
● Led duo AP 60 led-N	35520	35526	25	led	3620	IP20	⊕ 145 C
● duo AP 60S led-N	35530	35536	45,8	led	6260	IP20	⊕ 137 C
● Led DM duo AP 60S DM led-N	35540	35546	45,8	led	6260	IP20	⊕ 137 C
● Led EM duo AP 60 EM led-N	30760	30766	25	led	3620	IP20	⊕ 145 C
● duo AP 60S EM led-N	30770	30776	45,8	led	6260	IP20	⊕ 137 C
EL duo AP 60/2x24 EL	39380	39386	2x24	G5	4000	IP20	⊕ 83 A
duo AP 60/4x24 EL	39400	39406	4x24	G5	8000	IP20	⊕ 83 B
DM duo AP 60/4x24 DM	39680	39686	4x24	G5	8000	IP20	⊕ 83 B
EM duo AP 60/2x24 EM	30120	30126	2x24	G5	4000	IP20	⊕ 83 A

Colore struttura Structure color

● Nuova versione New version

CR
Alluminio brillantato (effetto cromato) Shined aluminium (chrome effect)

AL
Alluminio anodizzato Oxided aluminium

- Led** Equipaggiata con led 3000K - Equipped with led 3000K
- Led** Equipaggiata con led 4000K - Equipped with led 4000K
- Led DM** **Led DM** **DM** Dimmerabile PUSH/DALI
Dimmable PUSH/DALI (info page 10)
- Led EM** **Led EM** **EM** Emergenza (SA) 1h di serie – 3h a richiesta
Emergency 1h standard – 3h on request

Dark Light Pag. 168

Pag. 290

360°

uso interno
indoor using

Duo AP 90

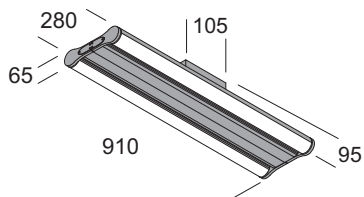

		Colore struttura Structure color		W _{max}	Icon	LUMEN	Icon	LUMEN/W	Icon	
Articolo Item		CR	AL							
		Codice Code								
● Led	duo AP 90 led-W	35550	35556	37,4	led	5320	IP20	⊕	142	C
●	duo AP 90S led-W	35560	35566	68,8	led	9380	IP20	⊕	136	C
● Led DM	duo AP 90S DM led-W	35570	35576	68,8	led	9380	IP20	⊕	136	C
● Led EM	duo AP 90 EM led-W	30780	30786	37,4	led	5320	IP20	⊕	142	C
●	duo AP 90S EM led-W	30790	30796	68,8	led	9380	IP20	⊕	136	C
● Led	duo AP 90 led-N	35580	35586	37,4	led	5320	IP20	⊕	142	C
●	duo AP 90S led-N	35590	35596	68,8	led	9380	IP20	⊕	136	C
● Led DM	duo AP 90S DM led-N	35600	35606	68,8	led	9380	IP20	⊕	136	C
● Led EM	duo AP 90 EM led-N	30800	30806	37,4	led	5320	IP20	⊕	142	C
●	duo AP 90S EM led-N	30810	30816	68,8	led	9380	IP20	⊕	136	C
EL	duo AP 90/2x39 EL	39390	39396	2x39	G5	7000	IP20	⊕	90	A
	duo AP 90/4x39 EL	39410	39416	4x39	G5	14000	IP20	⊕	90	B
DM	duo AP 90/4x39 DM	39690	39696	4x39	G5	14000	IP20	⊕	90	B
EM	duo AP 90/2x39 EM	30130	30136	2x39	G5	7000	IP20	⊕	90	A
	duo AP 90/4x39 EM	30210	30216	4x39	G5	14000	IP20	⊕	90	B

Colore struttura Structure color

● Nuova versione New version

CR
Alluminio brillantato (effetto cromato) *Shined aluminium (chrome effect)*

AL
Alluminio anodizzato *Oxided aluminium*

Led Equipaggiata con led 3000K - *Equipped with led 3000K*

Led Equipaggiata con led 4000K - *Equipped with led 4000K*

Led DM **Led DM** **DM** Dimmerabile PUSH/DALI
Dimmable PUSH/DALI (info page 10)

Led EM **Led EM** **EM** Emergenza (SA) 1h di serie – 3h a richiesta
Emergency 1h standard – 3h on request

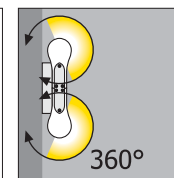
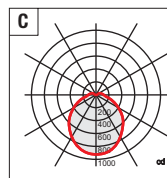
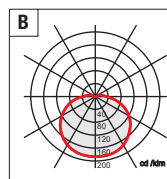
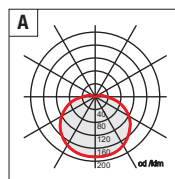

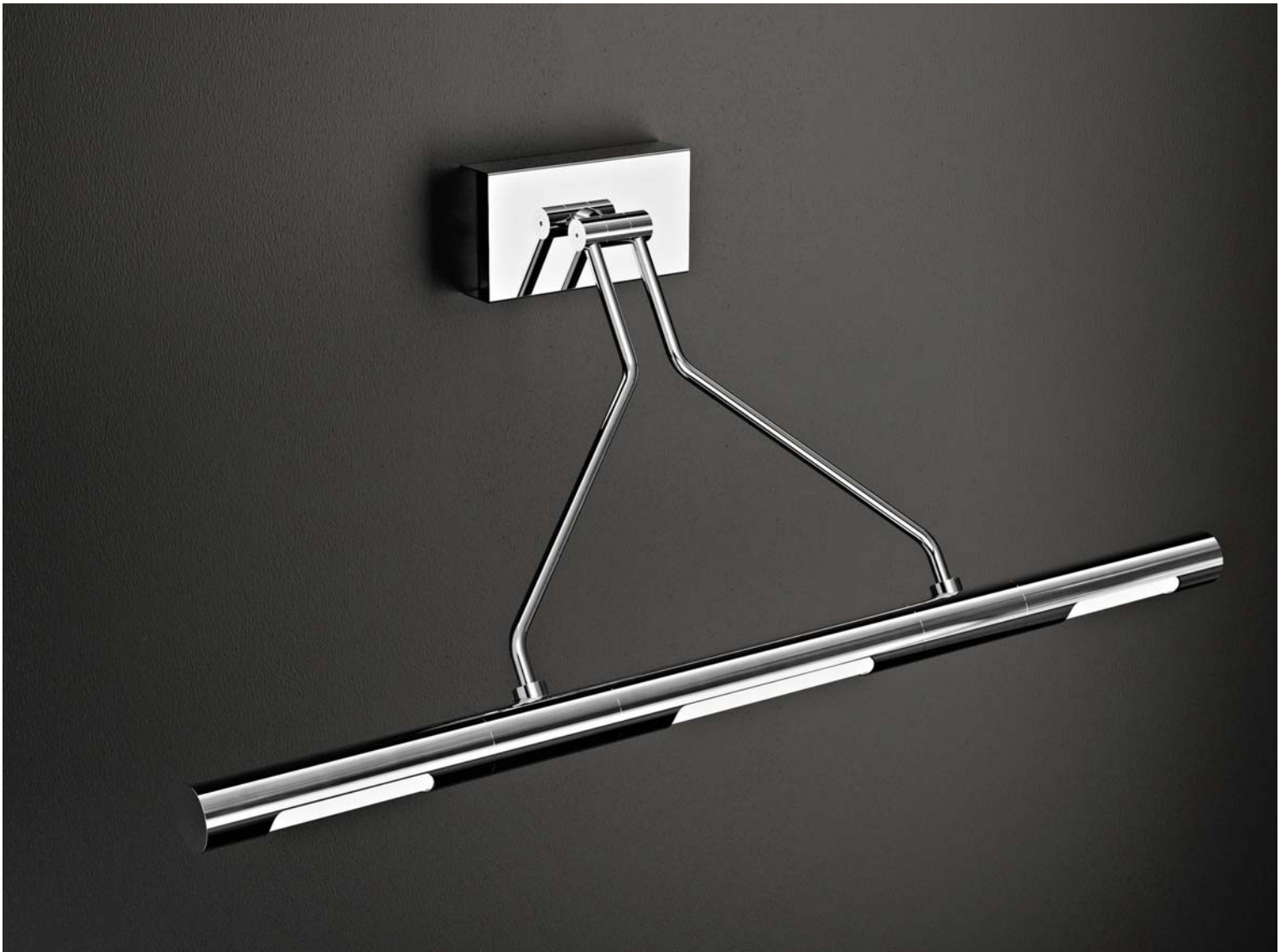

Ergo 60

Lampada da parete orientabile. Montatura in ottone cromato. Diffusori interni in policarbonato satinato. **Equipaggiata con LED COB. Alimentatore elettronico incorporato.**

Adjustable wall lamp. Structure made in chrome plated brass. Inside diffuser made of satin polycarbonate. **Equipped with COB LED. Electronic driver included.**

Lampe à mur réglable. Structure réalisée en laiton chromé. Diffuseur intérieur en polycarbonate satiné. **Equipé avec LED COB. Ballast électronique incorporé.**

Lámpara de pared giratoria. Estructura de latón cromado. Difusor interior de policarbonato satinado. **Suministrada con LED COB. Alimentador electrónico incluido.**

Schwenkbare Wandleuchte. Struktur aus verchromtem Messing. Innen Diffusor aus anisfarbenem Polycarbonat. **Ausgestattet mit LED COB. Eingebautem elektronischem Versorgungsgerät.**

Ergo 60

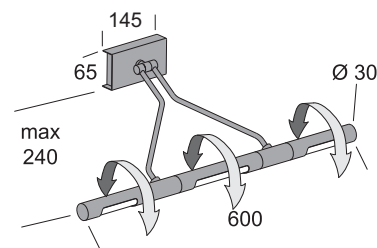

Colore struttura Structure color

Articolo Item	CR Codice Code	W _{max}		LUMEN			LUMEN/W	
● Led ergo 60-W	35610	16,4	led	1960	IP20		120	A
● Led ergo 60-N	35620	16,4	led	1960	IP20		120	A



Colore struttura Structure color

CR
Cromato Chrome

● Nuova versione New version

Led Equipaggiata con led 3000K - Equipped with led 3000K

Led Equipaggiata con led 4000K - Equipped with led 4000K

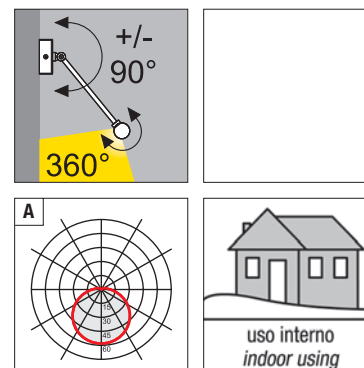



Ti-light AP

Lampada da parete. Diffusore in vetro Pyrex satinato. Struttura in metallo cromato.

Lámpara de pared. Difusor de vidrio Pyrex satinado. Estructura en metal cromado.

Wall lamp. Diffuser made in Pyrex glass with sandblasted surface. Structure made in chrome plated metal.

Wandleuchte. Diffusor aus satiniertem Pyrexglas. Struktur aus verchromtem Metall.

Lampe à mur. Diffuseur en verre Pyrex satiné. Structure réalisée en métal chromé.

Ti-light AP

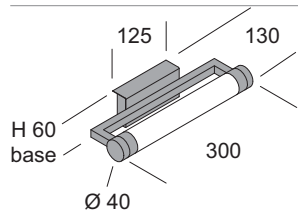

Colore struttura Structure color

Articolo Item

CR

W_{max}



LUMEN



LUMEN/W



Codice Code

HL	ti-light AP	37050	1x160	R7s	3100	IP20	⊕	19	A
----	-------------	-------	-------	-----	------	------	---	----	---

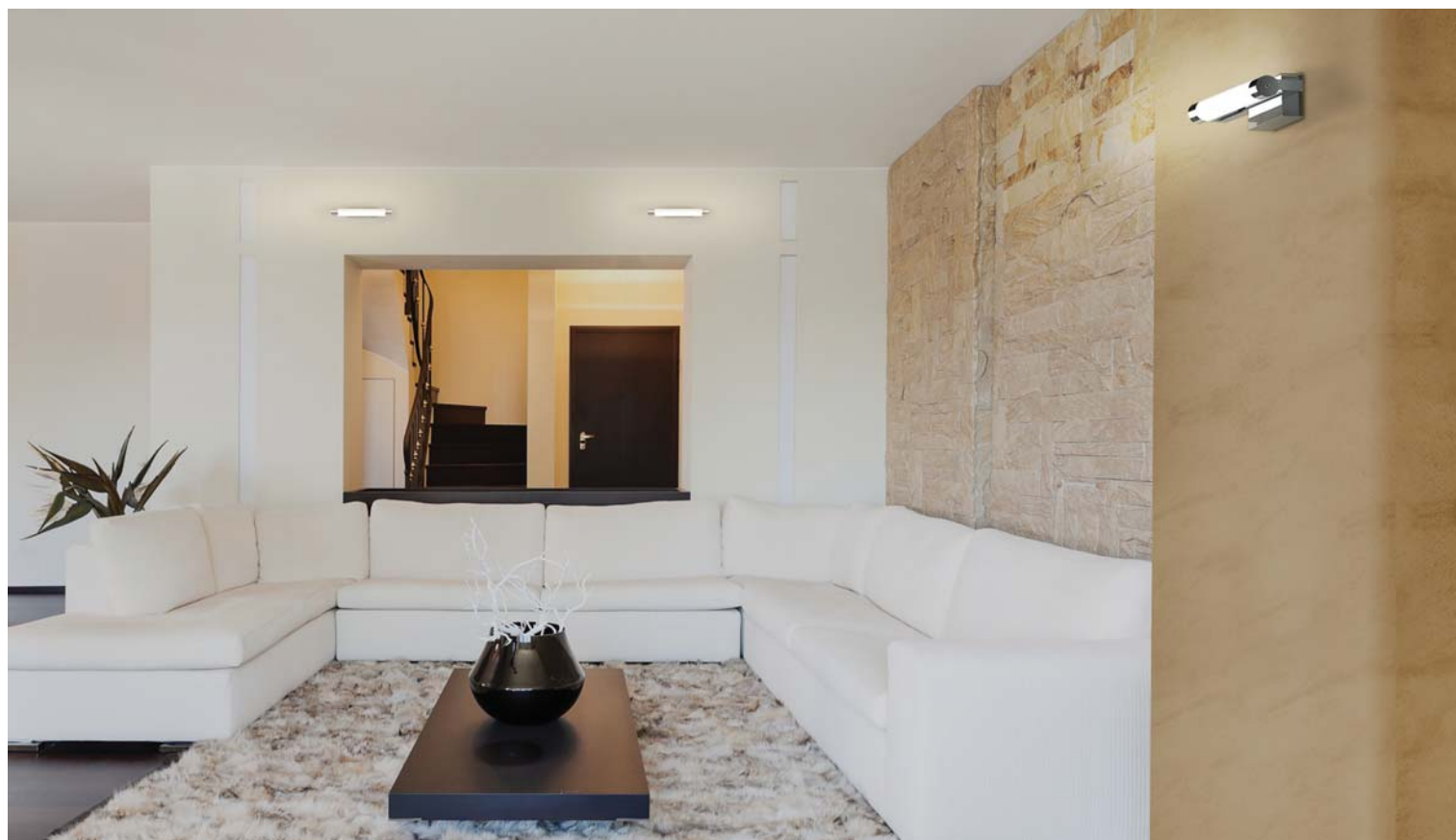

Colore struttura Structure color

CR

Cromato Chrome

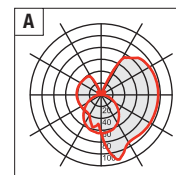
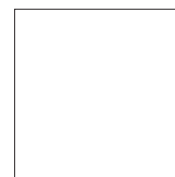
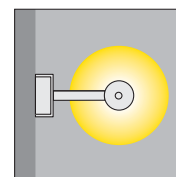



Flash

Lampada da parete o soffitto composta da faretto orientabili. Struttura in policarbonato trasparente con montatura in metallo bianco opaco ral 9016 o colore alluminio ral 9006. **Equipaggiata con led COB e alimentatore elettronico incorporato. Lente ad emissione stretta 25° o larga 40°.**

Wall or ceiling lamp composed by adjustable spot. Structure made in transparent polycarbonate with matt white painted metal frame ral 9016 or aluminium painted metal frame ral 9006. **Equipped with COB led and electronic driver included. Emission lens with narrow-angle 25° or wide-angle 40°.**

Lampe à mur ou à plafond réalisé avec projecteurs réglables. Structure en polycarbonate transparent avec monture en métal verni blanc opaque ral 9016 ou en métal verni couleur aluminium ral 9006. **Equipée avec led COB et ballast électronique incorporé. Lentille pour lumière diffuse étroit 25° ou large 40°.**

Lámpara de pared o de techo compuesta por proyectores giratorios. Estructura en policarbonato transparente con montura de metal pintado blanco opaco ral 9016 o pintado color aluminio ral 9006. **Suministrada con led COB y alimentador electronico incluido. Lente con haz estrecho de 25° o haz amplio de 40°.**

Eine Schwenkbare serie Spotlight. Struktur aus transparentem Polycarbonat mit Metall Frame weiß matt RAL 9016 oder RAL 9006 Aluminium Farbe. **Ausgestattet mit LED-COB und elektronisches Vorschaltgerät. Objektiv emittierende engen 25 ° oder 40 ° breit**

Flash

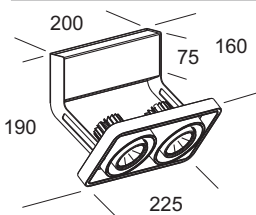

Colore struttura Structure color

Articolo Item	Colore struttura Structure color		W _{max}	LUMEN	IP	LUMEN/W	A
	AL	BI					
	Codice Code						
Led flash AS-W	34169	34161	14,2	led 1600	IP20	±	113 A
Led DM flash AS-W DM	34189	34181	14,2	led 1600	IP20	±	113 A
Led flash AS-N	34179	34171	14,2	led 1600	IP20	±	113 A
Led DM flash AS-N DM	34199	34191	14,2	led 1600	IP20	±	113 A
Led flash AL-W	34209	34201	14,2	led 1600	IP20	±	113 B
Led DM flash AL-W DM	34229	34221	14,2	led 1600	IP20	±	113 B
Led flash AL-N	34219	34211	14,2	led 1600	IP20	±	113 B
Led DM flash AL-N DM	34239	34231	14,2	led 1600	IP20	±	113 B



Colore struttura Structure color

AL RAL 9006
Alluminio Aluminium

BI RAL 9016
Bianco opaco Matt white

Led Equipaggiata con led 3000K - Equipped with led 3000K

Led Equipaggiata con led 4000K - Equipped with led 4000K

Led DM **Led DM** Dimmerabile PUSH/DALI
Dimmable PUSH/DALI (info page10)

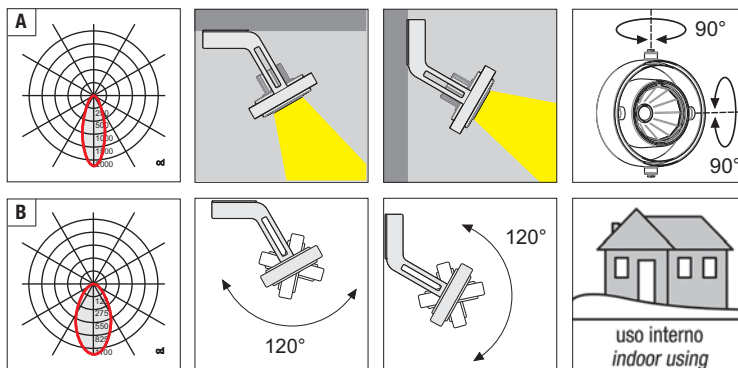



Vog

Lampada da parete o soffitto composta da faretto orientabili. Struttura in policarbonato trasparente con montatura in metallo bianco opaco ral 9016 o colore alluminio ral 9006. Diffusori in policarbonato opale. **Equipaggiata con led smd e alimentatore elettronico incorporato.**

Wall or ceiling lamp composed by adjustable spot. Structure made in transparent polycarbonate with matt white painted metal frame ral 9016 or aluminium painted metal frame ral 9006. Diffusers made in opal polycarbonate. **Equipped with smd led and electronic driver included.**

Lampe à mur ou à plafond réalisé avec projecteurs réglables. Structure en polycarbonate transparent avec monture en métal verni blanc opaque ral 9016 ou en métal verni couleur aluminium ral 9006. Diffuseurs en polycarbonate opale. **Equipée avec led smd et ballast électronique incorporé.**

Lámpara de pared o de techo compuesta por proyectores giratorios. Estructura en policarbonato transparente con montura de metal pintado blanco opaco ral 9016 o pintado color aluminio ral 9006. Difusors de policarbonato opale. **Suministrada con led smd y alimentador electronico incluido.**

Eine Schwenkbare serie Spotlight. Struktur aus transparentem Polycarbonat mit Metall Frame weiß matt RAL 9016 oder RAL 9006 Aluminium Farbe. Diffusoren in opal Polycarbonat. **Ausgestattet mit SMD-LEDs und elektronisches Vorschaltgerät.**

Colore struttura Structure color

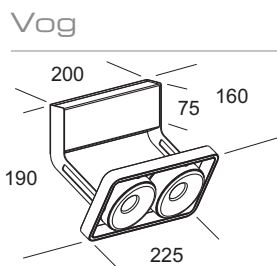

Articolo Item	Colore struttura Structure color		W _{max}	LUMEN	IP	LUMEN/W	A
	AL	BI					
	Codice Code						
Led vog A-W	34249	34241	12	led 1540	IP20	± 128	A
Led vog A-N	34259	34251	12	led 1540	IP20	± 128	A



Colore struttura Structure color

AL RAL 9006
Alluminio Aluminium

BI RAL 9016
Bianco opaco Matt white

- Led** Equipaggiata con led 3000K - Equipped with led 3000K
- Led** Equipaggiata con led 4000K - Equipped with led 4000K

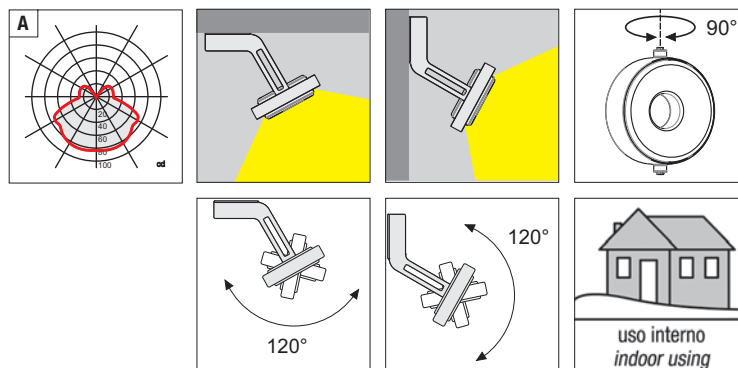

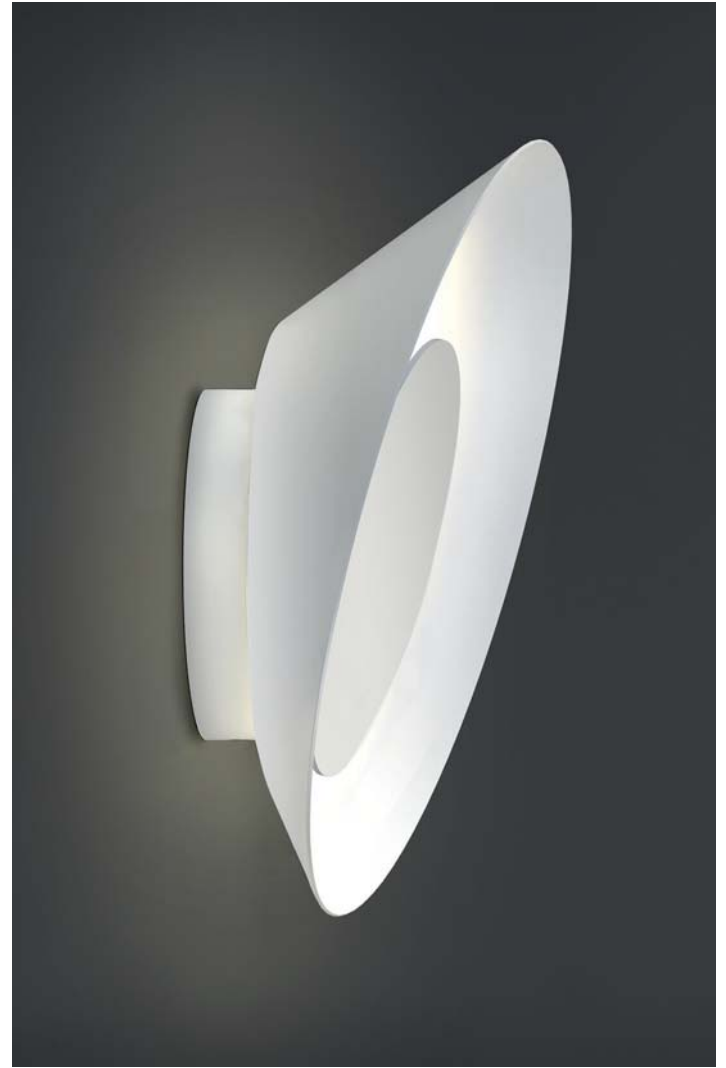

Ovetto

Lampada da parete. Struttura in metallo verniciato bianco opaco ral 9016.
Equipaggiata con led smd e alimentatore elettronico incorporato.

Wall lamp. Structure made in metal painted matt white ral 9016. **Equipped with smd led and electronic driver included.**

Lampe à mur. Structure réalisée en métal vernie blanc opaque ral 9016.
Equipée avec led smd et ballast électronique incorporé.

Lámpara de pared. Estructura de metal pintado blanco opaco ral 9016.
Suministrada con led smd y alimentador electronico incluido.

Wandleuchte. Struktur aus mattweiß lackiertem Metall Ral 9016. **Ausgestattet mit LED smd. Eingebautem elektronischem Versorgungsgerät.**

Colore struttura Structure color

Ovetto 230

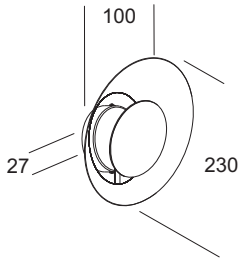

Articolo Item

BI
Codice Code

W_{max}



LUMEN



LUMEN/W



Led	ovetto 230 led-W	34041	8,33	led	1090	IP20	⊕	131	A
Led	ovetto 230 led-N	34051	8,33	led	1090	IP20	⊕	131	A

Ovetto 350

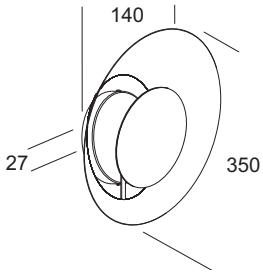

Led	ovetto 350 led-W	34061	15,3	led	2070	IP20	⊕	135	A
Led	ovetto 350 led-N	34071	15,3	led	2070	IP20	⊕	135	A



Colore struttura Structure color

BI RAL 9016
Bianco opaco Matt white

- Led Equipaggiata con led 3000K - Equipped with led 3000K
- Led Equipaggiata con led 4000K - Equipped with led 4000K

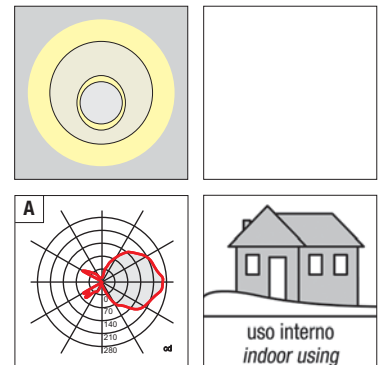



Pagoda

Lampada da parete per illuminazione di ambienti con luce emozionale. Struttura in metallo verniciato bianco opaco ral 9016. I diffusori interni sono orientabili e permettono di variare il fascio luminoso. **Equipaggiata con LED COB e alimentatore elettronico incorporato.**

Wall lamp to illuminate with emotional light. Structure made in metal painted matt white ral 9016. Inside diffusers rotate permitting to modify the luminous beam. **Equipped with COB LED and electronic driver included.**

Lampe à mur pour éclairage avec lumière émotionnelle. Structure réalisée en métal vernie blanc opaque ral 9016. Les diffuseurs internes sont réglables et permettent de varier le flux lumineux. **Équipée avec COB LED et ballast électronique incorporé.**

Lámpara de pared para iluminación de ambientes con luz emocional. Estructura de metal pintado blanco opaco ral 9016. Los difusores internos son ajustables permitiendo variar el rayo luminoso. **Suministrada con COB LED y alimentador electrónico incluido.**

Wandleuchte zur Beleuchtung von Räumen mit emotionale Licht. Struktur aus mattweiß lackiertem Metall Ral 9016. Die internen Diffusors sind einstellbar und ermöglicht somit die Ausrichtung des Lichtstrahls. **Ausgestattet mit COB LED. Eingebautem elektronischem Versorgungsgerät.**

Colore struttura Structure color

Pagoda

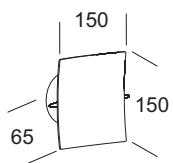

Articolo Item	BI Codice Code	W _{max}		LUMEN			LUMEN/W	
Led pagoda led-W	34081	13,2	led	1360	IP20	⊕	103	A
Led pagoda led-N	34091	13,2	led	1360	IP20	⊕	103	A



Colore struttura Structure color

BI RAL 9016
Bianco opaco Matt white

- Led** Equipaggiata con led 3000K - Equipped with led 3000K
- Led** Equipaggiata con led 4000K - Equipped with led 4000K

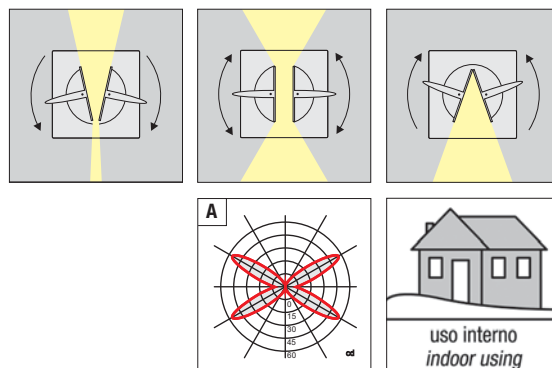

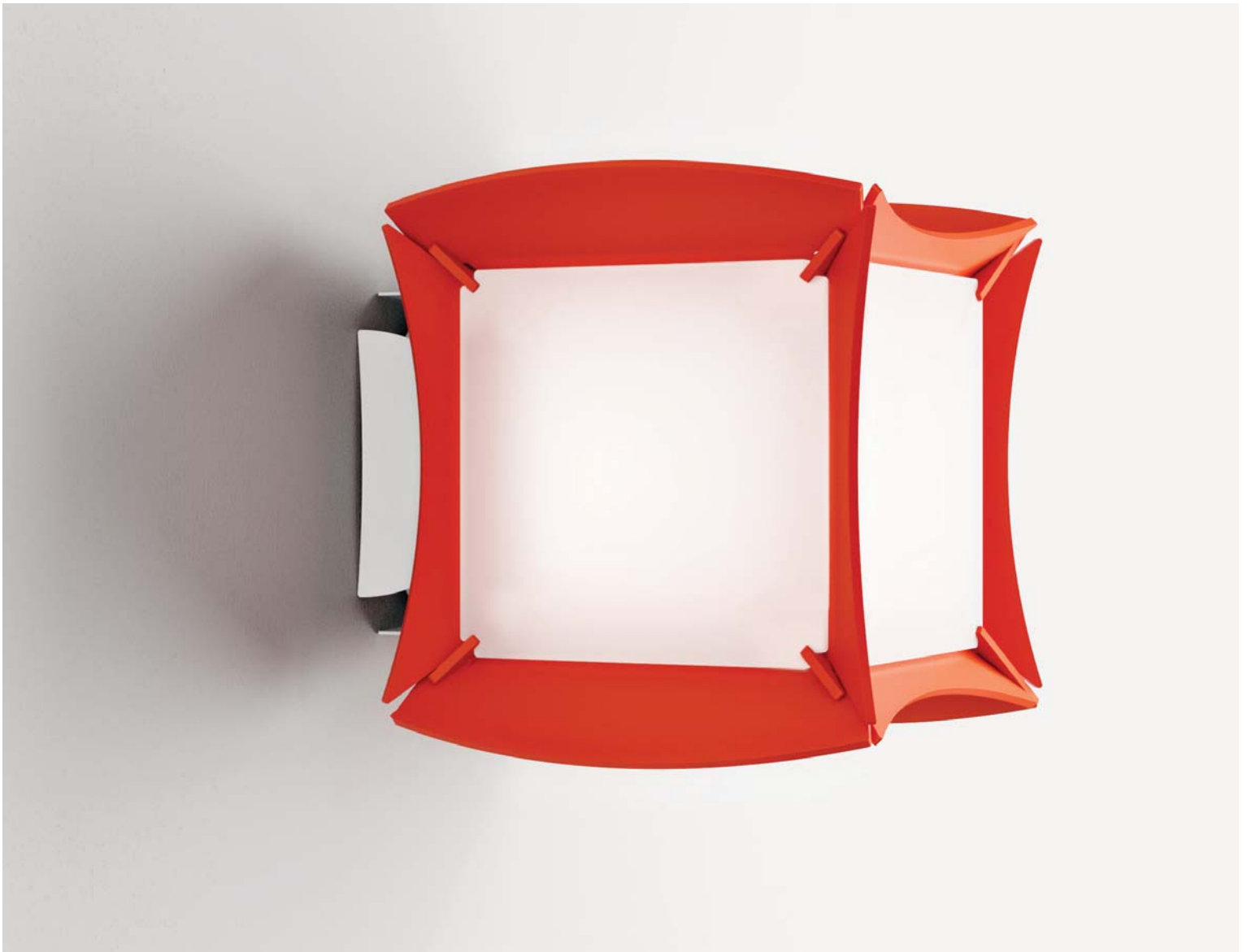

Kyo AP

Lampada da parete. Diffusore in policarbonato opale. Struttura in metallo verniciato. La struttura è realizzata combinando elementi planari senza utilizzo di viti o collanti. **Versione led equipaggiata con LED COB e alimentatore elettronico incorporato.**

Wall lamp. Diffuser made in opal polycarbonate. Structure made in painted metal. The structure is obtained combining simple planar elements without any screws or glue. **Led version equipped with COB LED and electronic gear included.**

Lampe à mur. Diffuseur réalisé en polycarbonate opale. Structure réalisée en métal verni. La structure est réalisée combinant des éléments plats sans utiliser des vis ou collant. **Version led équipée avec LED COB et ballast électronique incorporé.**

Lámpara de pared. Difusor de policarbonato opal. Estructura en metal pintado. La estructura está realizada combinando elementos planos sin el uso de tornillos o colas. **Versione led suministrada con LED COB y alimentador electrónico incorporado.**

Wandleuchte. Diffusor aus opalfarbenem Polycarbonat. Struktur aus lackiertem Metall. Die Struktur besteht aus einer Kombination ebener Elemente, ohne Schrauben oder Klebstoffe. **Ausführung LED zum LED COB und eingebautem elektronischem Versorgungsgerät.**

Kyo AP

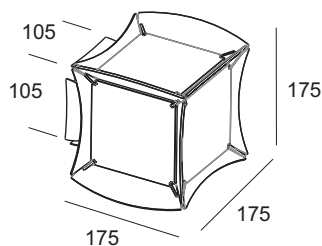

Colore struttura Structure color

Articolo Item

AL AR BI GI W_{max}



LUMEN



LUMEN/W



Codice Code

Articolo Item	AL	AR	BI	GI	W _{max}	LUMEN	LUMEN/W	Icon	Icon
E14 kyo AP	31516	31513	31511	31512	1x46	E14	700	IP20	□ 15 A
Led kyo AP led-W	34286	34283	34281	34282	9,3	led	975	IP20	⊕ 105 A
Led kyo AP led-N	34296	34293	34291	34292	9,3	led	975	IP20	⊕ 105 A

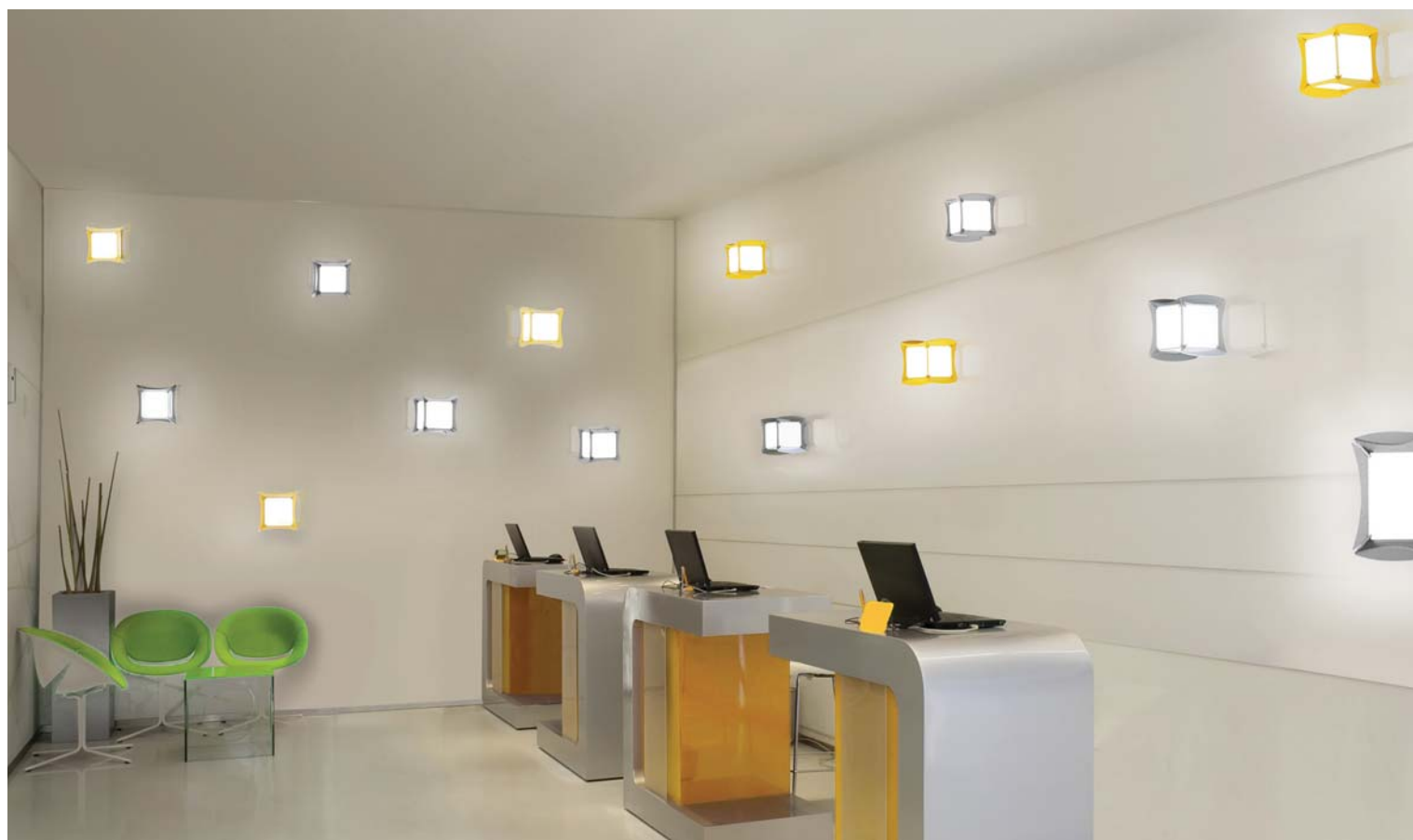

Colore struttura Structure color

AR RAL 2001
Arancio Rosso Opaco *Matt Red Orange*

BI RAL 9016
Bianco *White*

GI RAL 1028
Giallo Melone Opaco *Matt Melon Yellow*

AL RAL 9006
Alluminio opaco *Aluminium matt*

Led Equipaggiata con led 3000K - *Equipped with led 3000K*

Led Equipaggiata con led 4000K - *Equipped with led 4000K*

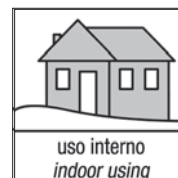
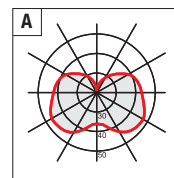
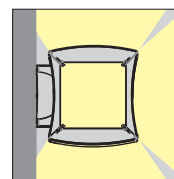



Asia AP

Lampade da parete. Struttura e diffusore in metallo verniciato con schermo in policarbonato opale. La versione bianca ha il cavo elettrico rosso, la versione nera ha la superficie interna del diffusore bianca ed il cavo elettrico bianco. **Equipaggiata con led smd e alimentatore elettronico incorporato.** La finitura ed il cavo possono cambiare a richiesta del cliente.

Wall lamp. Structure and diffuser made in painted metal with opal polycarbonate screen. Version white colour is equipped with red electric cable, version black colour has diffuser inside surface painted white and white electric cable. **Equipped with smd led and electronic driver included.** Finish and cable can change based on client request.

Lampe à mur. Structure et diffuseur réalisé en métal verni avec écran en polycarbonate opale. La version blanc est équipée avec câble électrique rouge, la version noire a la surface intérieure du diffuseur blanc et le câble électrique blanc. **Equipée avec led smd et ballast électronique incorporé.** La finition et le câble peuvent changé selon la demande du client.

Lámpara de pared. Estructura y difusor en metal pintado, pantalla en policarbonato opale. La version blanca tiene el cable rojo, la version negra tiene la superficie interna del difusor blanca y el cable blanco. **Suministrada con led smd y alimentador electronico incluido.** Acabado y cable puede cambiar a petición del cliente.

Wandleuchte. Struktur und Diffusor aus lackiertem Metall mit Bildschirm aus Opal Polykarbonat. Die weiße Version hat die rote Stromkabel, die schwarze Version hat die innere Diffusor Oberfläche der weißen und der schwarzen Netzkabel. **Ausgestattet mit SMD-LED und elektronische Stromversorgung.** Die Farbe und Kabel könne auf die Bedürfnisse des Kunden abgestimmt werden.

Colore struttura Structure color

Asia AP

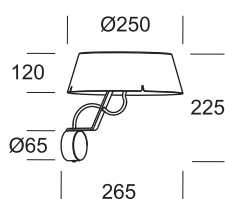

Articolo Item	Colore struttura Structure color		W _{max}	LUMEN	IP	LUMEN/W	A
	BI	NE					
	Codice Code						
Led asia AP led-W	35731	35737	8,33	led 1090	IP20	131	A
Led asia AP led-N	35741	35747	8,33	led 1090	IP20	131	A



Colore struttura Structure color

BI RAL 9016
Bianco opaco Matt white

NE RAL 9005
Nero opaco Matt black

- Led** Equipaggiata con led 3000K - Equipped with led 3000K
- Led** Equipaggiata con led 4000K - Equipped with led 4000K

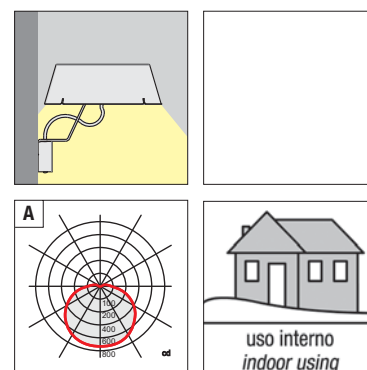

Chrome

Lampada da parete. Paralume in policarbonato traslucente cromato o in tessuto ignifugo autoestingente colore nero. Struttura in metallo cromato.

Wall lamp. Shade made of chrome translucent polycarbonate or auto extinguishing end not inflammable cloth black colour. Structure made in chrome plated metal.

Lampe à mur. Abat-jour en polycarbonate translucide chrome ou en tissu noir ignifuge et à extinction automatique. Structure réalisée en métal chromé.

Lámpara de pared. Pantalla de policarbonato translúcido cromado o en tejido ignifugo autoextinguible color negro. Estructura en metal cromado.

Wandleuchte. Lampenschirm aus verchromtem transluzent Polycarbonat oder schwarzfarben, feuerfestes selbstlöschendes Gewebe. Struktur aus verchromtem Metall.



Chrome CR

Chrome

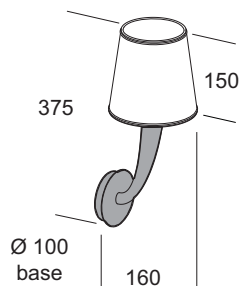

Articolo Item	Colore paralume Shade color		W _{max}		LUMEN		LUMEN/W	
	CR	NE						
E27 chrome	31040	31047	1x46	E27	700	IP40	15	A



Colore paralume Shade color

CR Cromato Chrome	NE Nero Black
-----------------------------	-------------------------

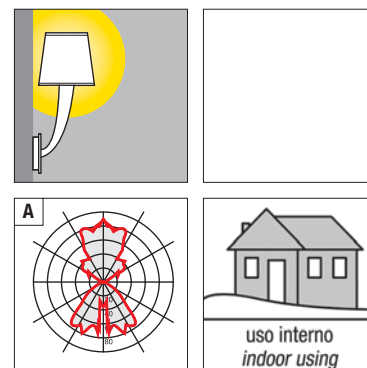



Dado plissé

Dado

Lampada da parete.

Dado plissé: paralume realizzato in tessuto pongé fasciato ignifugo autoestinguente colore avorio. Montatura in metallo cromato o verniciato colore avorio opaco ral 9001.

Dado: paralume in tessuto ignifugo autoestinguente marrone. Montatura in metallo cromato.

Wall lamp.

Dado plissé: shade made in auto extinguishing end not inflammable pongé fabric binding ivory colour. Frame made in chrome plated metal or ivory matt painted metal ral 9001.

Dado: shade made in auto extinguishing end not inflammable cloth brown colour. Frame made in chrome plated metal.

Lampe à mur.

Dado plissé: abat-jour en tissu pongé bandé ignifuge et à extinction automatique couleur ivoire. Monture réalisée en métal chromé ou vernie ivoire opaque ral 9001.

Dado: abat-jour en tissu marron ignifuge et à extinction automatique. Monture réalisée en métal chromé.

Lámpara de pared.

Dado plissé: pantalla en cinta de tejido pongé ignífugo autoextinguible color marfil. Montadura en metal cromado o pintado marfil opaco ral 9001.

Dado: pantalla de tejido ignífugo autoextinguible color marrón. Montadura en metal cromado.

Wandleuchte.

Dado plissé: Lampenschirm aus Pongé Stoff-Band elfenbeinfarben, feuerfestes selbstlöschendes Gewebe. Struktur aus verchromtem Metall oder Mat-telfenbein lackiertem Metall Ral 9001.

Dado: Lampenschirm braunfarben, feuerfestes selbstlöschendes Gewebe. Struktur aus verchromtem Metall.

Dado plissé

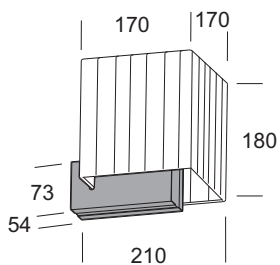

Colore struttura Structure color

Articolo Item	Colore struttura Structure color		W _{max}		LUMEN		LUMEN/W	
	CR	AV						
	Codice Code							
E27 dado plissé	31250	31252	1x46	E27	700	IP20	⊕	15 A
EL dado plissé EL	38120	38122	1x26	G24q-3	1800	IP20	⊕	69 A

Dado

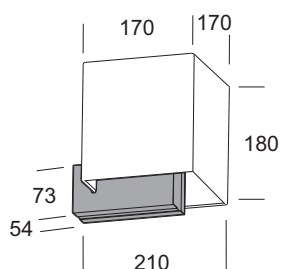

Articolo Item	Colore struttura Structure color		W _{max}		LUMEN		LUMEN/W	
	CR	AV						
E27 dado	31258		1x46	E27	700	IP20	⊕	15 A
EL dado EL	38128		1x26	G24q-3	1800	IP20	⊕	69 A



Colore struttura Structure color

CR Cromato Chrome	AV RAL 9001 Avorio Ivory
-----------------------------	------------------------------------

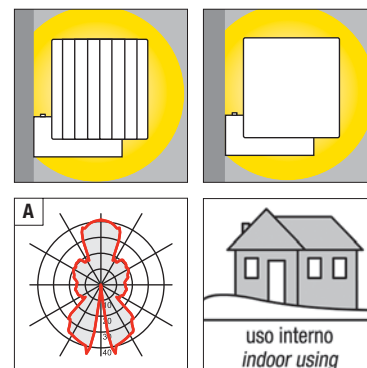



Retrò AP

Lampada da parete. Paralume in tessuto ignifugo autoestinguento colore avorio. Montatura in metallo cromato o dorato. **La finitura può cambiare a richiesta del cliente.**

Wall lamp. Shade made in auto extinguishing end not inflammable cloth ivory colour. Frame made in chrome plated metal or gold plated metal. **Finish can change based on client request.**

Lampe à mur. Abat-jour en tissu ivoire ignifuge et à extinction automatique. Monture réalisée en métal chromé ou en métal doré. **La finition peu changé selon la demande du client.**

Lámpara de pared. Pantalla en tejido ignifugo autoextinguible color marfil. Montadura de metal cromado o de metal dorado. **Acabado puede cambiar a petición del cliente.**

Wandleuchte. Lampenschirm elfenbeinfarben, feuerfestes selbstlöschendes Gewebe. Fassung aus verchromtem Metall oder vergoldetem Metall. **Die Farben können auf die Bedürfnisse des Kunden abgestimmt werden.**

Retrò AP

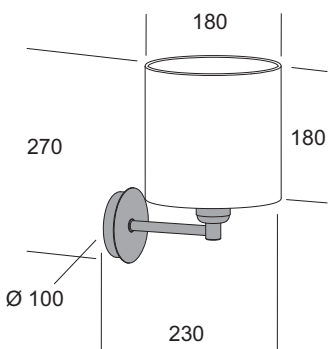

Articolo <i>Item</i>	Colore struttura <i>Structure color</i>		W _{max}		LUMEN		LUMEN/W		
	CR	OR							
	Codice <i>Code</i>								
E27 retrò AP	31210	31212	1x46	E27	700	IP40	⊕	15	A

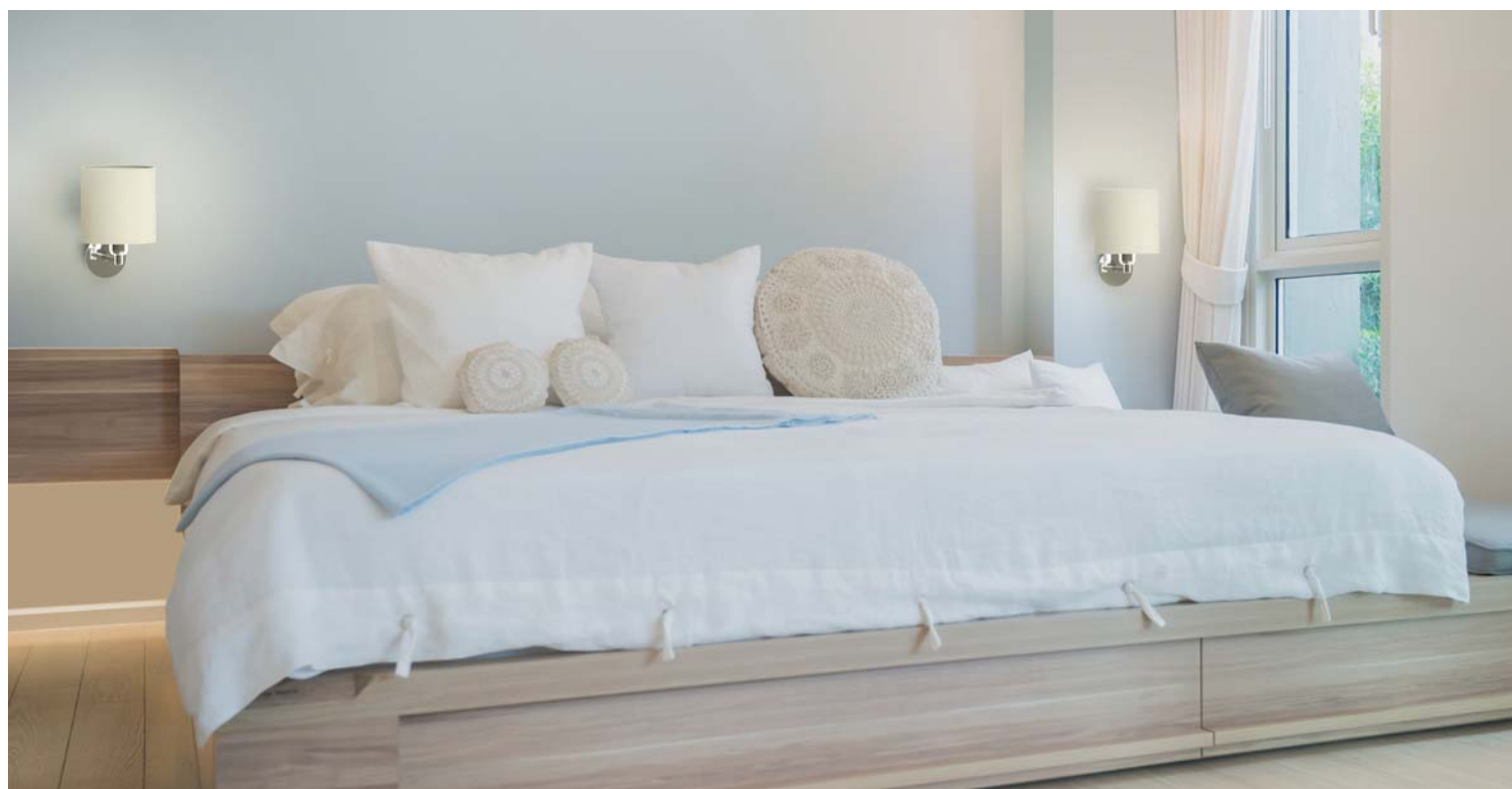

Colore struttura *Structure color*

CR
Cromato *Chrome*

OR
Dorato 24K *Gold plated 24K*

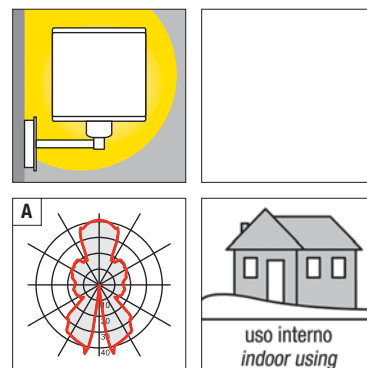



Segno

Lampada da parete. Diffusore in vetro soffiato opale triplex satinato. Montatura in metallo cromato o verniciato bianco opaco ral 9016.

Wall lamp. Diffuser made in blown satin opal triplex glass. Frame made in chrome plated metal or white matt painted metal ral 9016.

Lampe à mur. Diffuseur en verre soufflé opale triplex satiné. Monture réalisée en métal chromé ou vernie blanc opaque ral 9016.

Lámpara de pared. Difusor de vidrio soplado opal triplex satinado. Montadura en metal cromado o pintado blanco opaco ral 9016.

Wandleuchte. Diffusor aus geblasenem Triplex-Opalglas, satiniert. Struktur aus verchromtem Metall oder mattweiß lackiertem Metall Ral 9016.

Segno

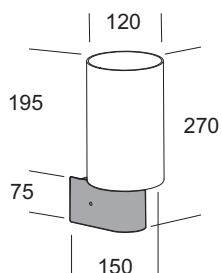

Colore struttura Structure color

Articolo Item	Colore struttura Structure color		W _{max}		LUMEN		LUMEN/W		
	CR	BI							
	Codice Code								
E27 segno	31220	31221	1x77	E27	1320	IP20	⊕	17	A
EL segno EL	38110	38111	1x26	G24q-3	1800	IP20	⊕	69	A



Colore struttura Structure color

CR
Cromato *Chrome*

BI **RAL 9016**
Bianco opaco *Matt white*

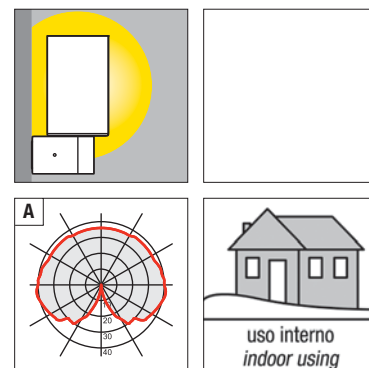

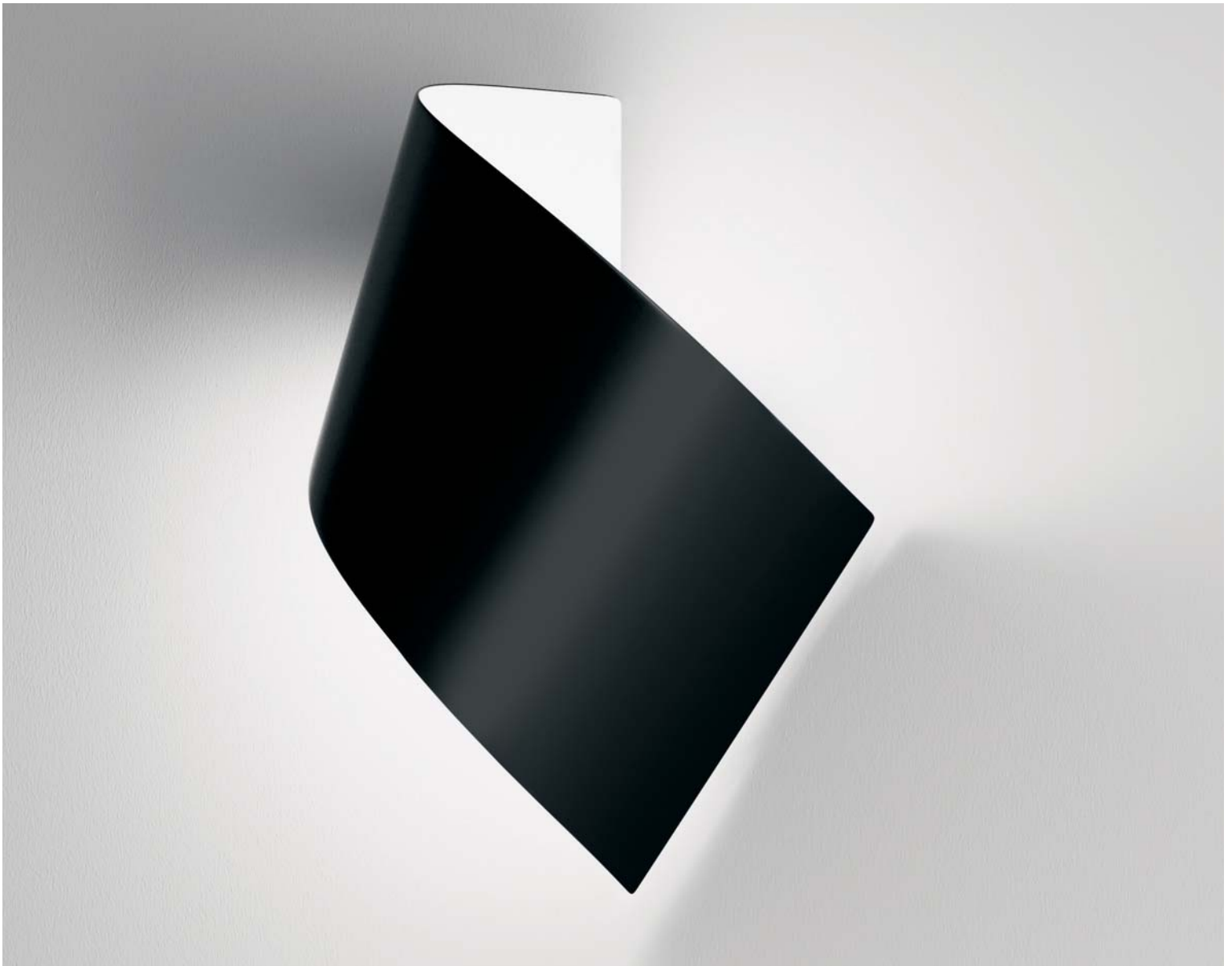

Gina

Lampada da parete. Struttura in metallo verniciato bianco opaco ral 9016 o nero opaco ral 9005 con interno bianco. **Equipaggiata con led smd.**

Wall lamp. Structure made in metal painted matt white ral 9016 or matt black ral 9005 with inside surface painted white. **Equipped with smd led.**

Lampe à mur. Structure réalisée en métal vernie blanc opaque ral 9016 ou noire opaque ral 9005 avec surface intérieure couleur blanc. **Equipée avec led smd.**

Lámpara de pared. Estructura de metal pintado blanco opaco ral 9016 o negro opaco ral 9005 con la superficie interna blanca. **Suministrada con led smd.**

Wandleuchte. Struktur aus mattweiß lackiertem Metall Ral 9016 oder mattschwarz lackiertem Metall Ral 9005 mit die Innenfläche weiß lackiert. **Ausgestattet mit led smd.**

Gina DX

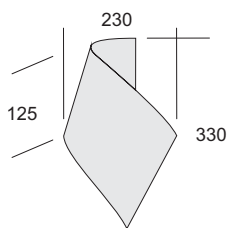

Colore struttura Structure color

Articolo Item	Colore struttura Structure color		W _{max}		LUMEN		LUMEN/W	
	BI	NE						
	Codice Code							
gina dx led-W	34001	34007	17	led	1590	IP20	⊕	94 A
gina dx led-N	34021	34027	17	led	1590	IP20	⊕	94 A

Gina SX

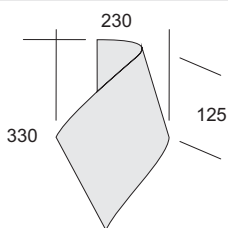

gina sx led-W	34011	34017	17	led	1590	IP20	⊕	94 A
gina sx led-N	34031	34037	17	led	1590	IP20	⊕	94 A



Colore struttura Structure color

BI RAL 9016	NE RAL 9005
Bianco opaco Matt white	Nero opaco Matt black

- Equipaggiata con led 3000K - Equipped with led 3000K
- Equipaggiata con led 4000K - Equipped with led 4000K

Compatibile con dimmer a taglio di fase (TRIAC)
Compatible with phase cut dimmer (TRIAC)

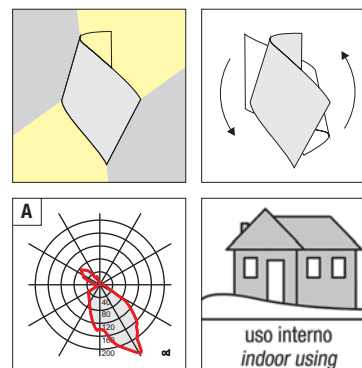



Lollo

Lampada da parete. Struttura in metallo verniciato bianco opaco ral 9016 o nero opaco ral 9005 con interno bianco. **Equipaggiata con led smd.**

Wall lamp. Structure made in metal painted matt white ral 9016 or matt black ral 9005 with inside surface painted white. **Equipped with smd led.**

Lampe à mur. Structure réalisée en métal vernie blanc opaque ral 9016 ou noire opaque ral 9005 avec surface intérieure couleur blanc. **Equipée avec led smd.**

Lámpara de pared. Estructura de metal pintado blanco opaco ral 9016 o negro opaco ral 9005 con la superficie interna blanca. **Suministrada con led smd.**

Wandleuchte. Struktur aus mattweiß lackiertem Metall Ral 9016 oder mattschwarz lackiertem Metall Ral 9005 mit die Innenfläche weiß lackiert. **Ausgestattet mit led smd.**

Lollo

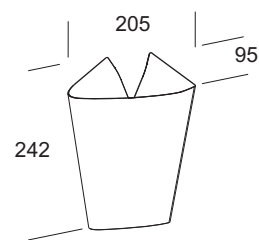

Colore struttura Structure color

Articolo Item

BI NE

W_{max}



LUMEN



LUMEN/W



Codice Code

Articolo Item	BI	NE	W _{max}	Icon	LUMEN	Icon	LUMEN/W	Icon
Led lollo led-W	35981	35987	17	led	1590	IP20	94	A
Led lollo led-N	35991	35997	17	led	1590	IP20	94	A



Colore struttura Structure color

BI RAL 9016 Bianco opaco Matt white
NE RAL 9005 Nero opaco Matt black

Led Equipaggiata con led 3000K - Equipped with led 3000K
Led Equipaggiata con led 4000K - Equipped with led 4000K

Compatibile con dimmer a taglio di fase (TRIAC)
Compatible with phase cut dimmer (TRIAC)

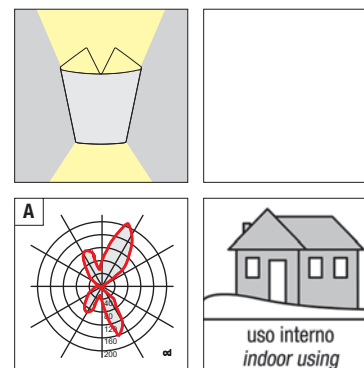

14 applique interni/esterni
wall lights indoor/outdoor

150 plafoniere interni/esterni
ceiling bowls indoor/outdoor

248 testaletto
bed head units

258 sospensioni
suspensions

344 lampade
lamps

384 lampioni ed incassi
bollards & recessed lights

450 indice
index



Aurora

Lampada da parete. Struttura in metallo verniciato bianco opaco ral 9016 con fresatura orizzontale che determina un originale gioco di luce. Diffusori in vetro satinato. Montatura in metallo verniciato bianco ral 9016. Completa di 4 filtri colorati (opale, giallo, rosso, blu) applicabili sulla fresatura orizzontale. **Versione LED equipaggiata con led smd e alimentatore elettronico incorporato.**

Wall lamp. Structure made in metal painted matt white ral 9016 with horizontal milling that permits an original play of light. Diffusers made in satin glass. Frame made in white painted metal ral 9016. Complete with 4 coloured filters (opal, yellow, red, blue) to be used on horizontal milling. **LED version equipped with smd led and electronic driver included.**

Lampe à mur. Structure réalisée en métal vernie blanc opaque ral 9016 avec un fraisage horizontal qui permet un jeu de lumière original. Diffuseurs en verre satinés. Monture réalisée en métal vernie blanc ral 9016. Complete de 4 filtres colorés (opale, jaune, rouge, bleu) applicable au fraisage horizontal. **Version LED équipée avec led smd et ballast électronique incorporé.**

Lámpara de pared. Estructura de metal pintado blanco opaco ral 9016 presenta un fresado horizontal que determina un original juego de luz. Difusors de vidrio satinado. Montadura de metal pintado blanco ral 9016. Filtros de 4 color (opal, amarillo, rojo, azul) aplicable en el fresado horizontal. **Version LED suministrada con led smd y alimentador electronico incluido.**

Wandleuchte. Struktur aus mattweiß lackiertem Metall Ral 9016 mit waagrechter Fräsung, die ein originelles Lichtspiel erzeugt. Diffusor aus satiniertem Glas. Fassung aus weiß lackiertem Metall Ral 9016. Farbiger 4 Filter, (Opal, gelb, rot, blau) für waagrechter Fräsung. **Ausführung LED zum led smd und integriert Versorgungsgerät elektronisch.**

Aurora 250

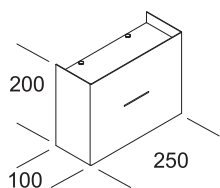

Colore struttura Structure color

Articolo Item	BI	W _{max}		LUMEN		LUMEN/W	
	Codice Code						
aurora 250	32231	1x77	E27	1320	IP20	17	A
aurora 250 led-W	36841	12,4	led	1700	IP20	137	A
aurora 250 led-N	36851	12,4	led	1700	IP20	137	A
aurora 250 EL	38031	1x26	G24q-3	1800	IP20	69	A

Aurora 430

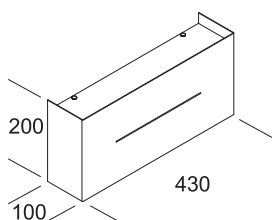

aurora 430	32241	2x77	E27	2640	IP20	17	A
aurora 430 led-W	36861	23	led	3120	IP20	136	A
aurora 430 EM led-W	30481	23	led	3120	IP20	136	A
aurora 430 led-N	36871	23	led	3120	IP20	136	A
aurora 430 EM led-N	30491	23	led	3120	IP20	136	A
aurora 430 EL	38041	2x26	G24q-3	3600	IP20	69	A
aurora 430 EM	30191	2x26	G24q-3	3600	IP20	69	A

Colore struttura Structure color

RAL 9016
Bianco opaco *Matt white*

Nuova versione New version

Equipaggiata con led 3000K - *Equipped with led 3000K*

Equipaggiata con led 4000K - *Equipped with led 4000K*

Emergenza (SA) 1h di serie – 3h a richiesta
Emergency 1h standard – 3h on request

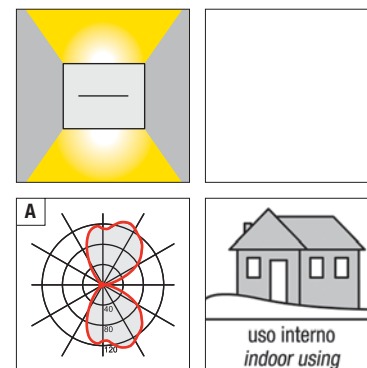

14 applique interni/esterni
wall lights indoor/outdoor

150 plafoniere interni/esterni
ceiling bowls indoor/outdoor

248 testataletto
bed head units

258 sospensioni
suspensions

344 lampade
lamps

384 lampioni ed incassi
bollards & recessed lights

450 indice
index



Vip

Lampada da parete e da soffitto. Diffusore in vetro extrachiaro satinato bianco. Montatura in metallo verniciato bianco ral 9016. Profili laterali in metallo cromato o nickel spazzolato.

Versione LED equipaggiata con led smd e alimentatore elettronico incorporato.

Wall and ceiling lamp. Diffuser made in extra-clear white satin glass. Frame made in white painted metal ral 9016. Lateral profile made in chrome plated metal or brushed nickel metal.

LED version equipped with smd led and electronic driver included.

Lampe à mur et à plafond. Diffuseur en verre extra clair satiné blanc. Monture réalisée en métal vernie blanc ral 9016. Profil latéral en métal chromé ou nickel brossé.

Version LED équipée avec led smd et ballast électronique incorporé.

Lámpara de pared y de techo. Difusor de vidrio extraclaro satinado blanco. Montadura en metal pintado blanco ral 9016. Perfiles laterales en metal cromado o niquel satinado.

Version LED suministrada con led smd y alimentador electronico incluido.

Wand- und Deckenleuchte. Diffusor aus extra hellem satiniertem weißem Glas. Fassung aus weiß lackiertem Metall Ral 9016. Seitenprofile aus verchromtem Metall oder gebürstet Nickel farbigem Metall.

Ausführung LED zum led smd und integriert Versorgungsgerät elektronisch.

Vip 1

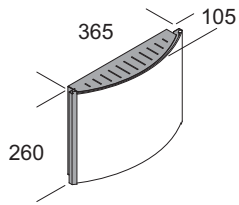

Articolo Item	Colore profili Profiles color		W _{max}	E27	LUMEN	IP	LUMEN/W	A	
	CR	NS							
		Codice Code							
E27 vip 1		32341 32346	2x46	E27	1400	IP20	⊕	15	A
Led vip 1 led-W	●	35111 35116	12,4	led	1700	IP20	⊕	137	B
Led EM vip 1 EM led-W	●	30501 30506	12,4	led	1700	IP20	⊕	137	B
Led vip 1 led-N	●	35121 35126	12,4	led	1700	IP20	⊕	137	B
Led EM vip 1 EM led-N	●	30511 30516	12,4	led	1700	IP20	⊕	137	B
EL vip 1 EL		39571 39576	2x26	G24q-3	3600	IP20	⊕	69	A
EM vip 1 EM		30281 30286	2x26	G24q-3	3600	IP20	⊕	69	A

Vip 2

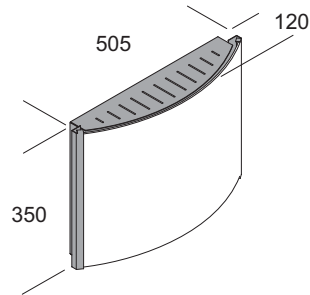

E27 vip 2		32351 32356	2x77	E27	2640	IP20	⊕	17	A
Led vip 2 led-W	●	35131 35136	23	led	3120	IP20	⊕	136	B
Led DM vip 2 DM led-W	●	35141 35146	23	led	3120	IP20	⊕	136	B
Led EM vip 2 EM led-W	●	30521 30526	23	led	3120	IP20	⊕	136	B
Led vip 2 led-N	●	35151 35156	23	led	3120	IP20	⊕	136	B
Led DM vip 2 DM led-N	●	35161 35166	23	led	3120	IP20	⊕	136	B
Led EM vip 2 EM led-N	●	30531 30536	23	led	3120	IP20	⊕	136	B
EL vip 2 EL		39181 39186	2x42(a)	GX24q-4	6400	IP20	⊕	76	A
DM vip 2 DM	●	38081 38086	2x42	GX24q-4	6400	IP20	⊕	76	A
EM vip 2 EM/84		30291 30296	2x42(a)	GX24q-4	6400	IP20	⊕	76	A

Colore profili Profiles color

CR Cromato Chrome **NS** Nickel spazzolato Brushed nickel

● Nuova versione New version

- Led** Equipaggiata con led 3000K - Equipped with led 3000K
- Led** Equipaggiata con led 4000K - Equipped with led 4000K
- Led DM** **Led DM** **DM** Dimmerabile PUSH/DALI
Dimmable PUSH/DALI (info page10)
- Led EM** **Led EM** **EM** Emergenza (SA) 1h di serie – 3h a richiesta
Emergency 1h standard – 3h on request

(a) Equipaggiato con alimentatore multipotenza per l'utilizzo di lampade da 26W-32W o 42W.
Equipped with multi-power ballast to use bulbs of 26W-32W or 42W.

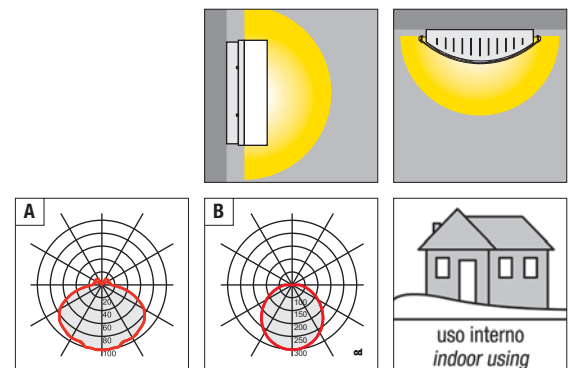



Vela

Lampada da parete. Diffusore in vetro extrachiaro serigrafato bianco satinato. Montatura in metallo verniciato bianco ral 9016.

Versione LED equipaggiata con led smd e alimentatore elettronico incorporato.

Wall lamp. Diffuser made in extra-clear glass with white satin serigraphy. Frame made in white painted metal ral 9016.

LED version equipped with smd led and electronic driver included.

Lampe à mur. Diffuseur en verre extra clair avec sérigraphie blanc satiné. Monture réalisée en métal vernie blanc ral 9016.

Version LED équipée avec led smd et ballast électronique incorporé.

Lámpara de pared. Difusor de vidrio extraclaro serigrafiado blanco satinado. Montadura en metal pintado blanco ral 9016.

Version LED suministrada con led smd y alimentador electronico incluido.

Wandleuchte. Diffusor aus extrahellem Glas mit Siebdruck, weiß satiniert. Fassung aus weiß lackiertem Metall Ral 9016.

Ausführung LED zum led smd und integriert Versorgungsgerät elektronisch.

Vela

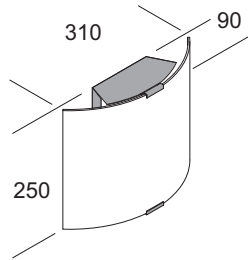

Articolo <i>Item</i>	Colore vetro <i>Glass color</i>		W _{max}		LUMEN		LUMEN/W		
	OP	Codice <i>Code</i>							
<input type="checkbox"/> E27 vela		32191	1x77	E27	1320	IP20	⊕	17	A
● <input type="checkbox"/> Led vela led-W		36821	12,4	led	1700	IP20	⊕	137	B
● <input type="checkbox"/> Led EM vela EM led-W		30421	12,4	led	1700	IP20	⊕	137	B
● <input type="checkbox"/> Led vela led-N		36831	12,4	led	1700	IP20	⊕	137	B
● <input type="checkbox"/> Led EM vela EM led-N		30431	12,4	led	1700	IP20	⊕	137	B
<input type="checkbox"/> EL vela EL		39561	1x26	G24q-3	1800	IP20	⊕	69	A
<input type="checkbox"/> EM vela EM		30381	1x26	G24q-3	1800	IP20	⊕	69	A

Colore vetro *Glass color*

OP
Opale satinato *Satin opal*

- Led Equipaggiata con led 3000K - *Equipped with led 3000K*
- Led Equipaggiata con led 4000K - *Equipped with led 4000K*
- Led EM Led EM EM Emergenza (SA) 1h di serie – 3h a richiesta
Emergency 1h standard – 3h on request

● Nuova versione *New version*

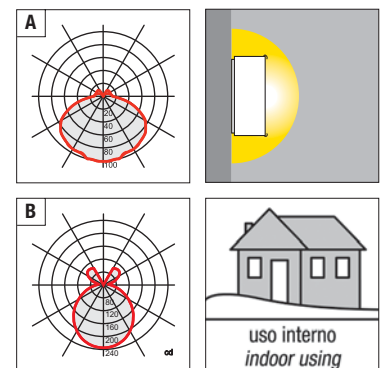

14 applique interni/esterni
wall lights indoor/outdoor

150 plafoniere interni/esterni
ceiling bowls indoor/outdoor

248 testaletto
bed head units

258 sospensioni
suspensions

344 lampade
lamps

384 lampioni ed incassi
bollards & recessed lights

450 indice
index



Sirya

Lampada da parete. Diffusore in vetro lucido serigrafato. Montatura in metallo verniciato bianco ral 9016. Viti cromate. **Versione LED equipaggiata con led smd e alimentatore elettronico incorporato.**

Wall lamp. Diffuser made in shiny glass with serigraphy. Frame made in white painted metal ral 9016. Chrome screws. **LED version equipped with smd and electronic driver included.**

Lampe à mur. Diffuseur en verre brillant avec sérigraphie. Monture réalisée en métal vernie blanc ral 9016. Vis chromée. **Version LED équipée avec led smd et ballast électronique incorporé.**

Lámpara de pared. Difusor de vidrio brillante serigrafiado. Montadura en metal pintado blanco ral 9016. Tornillos cromados. **Version LED suministrada con led smd y alimentador electronico incluido.**

Wandleuchte. Diffusor aus glänzendem Glas mit Siebdruck. Fassung aus weiß lackiertem Metall Ral 9016. Verchromte Schrauben. **Ausführung LED zum led smd und integriert Versorgungsgerät elektronisch.**

Sirya 1

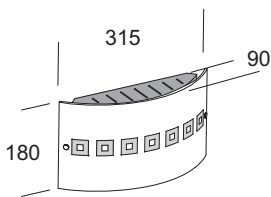

Articolo Item	Codice Code	W _{max}		LUMEN		LUMEN/W	
E27 sirya 1	32161	1x46	E27	700	IP20	⊕	15 A
● Led sirya 1 led-W	35631	8,6	led	1300	IP20	⊕	151 B
● Led sirya 1 led-N	35641	8,6	led	1300	IP20	⊕	151 B
EL sirya 1 EL	39052	1x26	G24q-3	1800	IP20	⊕	69 A

Sirya 2

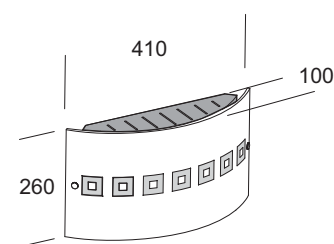

E27 sirya 2	32171	2x57	E27	1830	IP20	⊕	16 A
● Led sirya 2 led-W	35651	15,8	led	2360	IP20	⊕	149 B
● Led EM sirya 2 EM led-W	30821	15,8	led	2360	IP20	⊕	149 B
● Led sirya 2 led-N	35661	15,8	led	2360	IP20	⊕	149 B
● Led EM sirya 2 EM led-N	30831	15,8	led	2360	IP20	⊕	149 B
EL sirya 2 EL	39062	2x26	G24q-3	3600	IP20	⊕	69 A
EM sirya 2 EM/52	30002	2x26	G24q-3	3600	IP20	⊕	69 A

● Nuova versione *New version*

- Led** Equipaggiata con led 3000K - *Equipped with led 3000K*
- Led** Equipaggiata con led 4000K - *Equipped with led 4000K*
- Led EM** **Led EM** **EM** Emergenza (SA) 1h di serie – 3h a richiesta
Emergency 1h standard – 3h on request

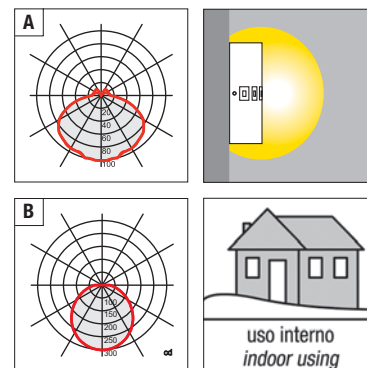



Trilyum AP

Lampada da parete. Diffusore in polipropilene con serigrafia colore avorio. Montatura in metallo verniciato bianco ral 9016. Decorì in metallo verniciato alluminio ral 9006. **Versione LED equipaggiata con led smd e alimentatore elettronico incorporato.**

Wall lamp. Diffuser made in polypropylene with serigraphy ivory colour. Frame made in white painted metal ral 9016. Details made in metal painted aluminium ral 9006. **LED version equipped with smd led and electronic driver included.**



Lampe à mur. Diffuseur en polypropylène avec sérigraphie couleur ivoire. Monture réalisée en métal verni blanc ral 9016. Détails en métal verni couleur aluminium ral 9006. **Version LED équipée avec led smd et ballast électronique incorporé.**

Lámpara de pared. Difusor de polipropileno con serigrafía color marfil. Montadura en metal pintado blanco ral 9016. Detalles de metal pintado aluminio ral 9006. **Version LED suministrada con led smd y alimentador electrónico incluido.**

Wandleuchte. Diffusor aus Polypropylen mit Siebdruck, elfenbeinfarben. Fassung aus weiß lackiertem Metall Ral 9016. Details aus Aluminium lackiertem Metall Ral 9006. **Ausführung LED zum led smd und integriert Versorgungsgerät elektronisch.**

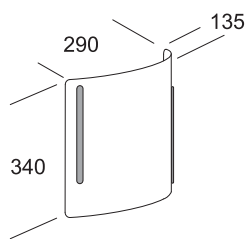
Trilyum AP



Articolo Item	Codice Code	W _{max}		LUMEN		LUMEN/W	
E27 trilyum AP	32300	1x77	E27	1320	IP20	17	A
● Led trilyum AP led-W	35960	12,4	led	1700	IP20	137	B
● Led trilyum AP led-N	35970	12,4	led	1700	IP20	137	B
EL trilyum AP EL	39120	1x26	G24q-3	1800	IP20	69	A



● Nuova versione *New version*

Led Equipaggiata con led 3000K - *Equipped with led 3000K*

Led Equipaggiata con led 4000K - *Equipped with led 4000K*

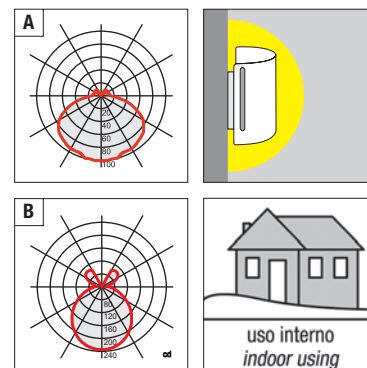



Spicchio

Lampada da parete. Diffusore in vetro soffiato opale triplex satinato. Montatura in metallo verniciato bianco ral 9016. Disponibile versione con interruttore a tirante. Pomolo del tirante in ottone cromato. **Versione LED equipaggiata con led smd e alimentatore elettronico incorporato.**

Wall lamp. Diffuser made in blown satin opal triplex glass. Frame in white painted metal ral 9016. Available version with tie rod switch. Knob of tie rod made in chrome metal. **LED version equipped with smd led and electronic driver included.**

Lampe à mur. Diffuseur en verre soufflé opale triplex satiné. Monture réalisée en métal vernie blanc ral 9016. Disponible avec interrupteur à tirant. Poignée de l'interrupteur réalisée en métal chromé. **Version LED équipée avec led smd et ballast électronique incorporé.**

Lámpara de pared. Difusor de vidrio soplado opal triplex satinado. Montadura en metal pintado blanco ral 9016. Disponible con interruptor de tirante. Pomo del tirante en latón cromado. **Version LED suministrada con led smd y alimentador electrónico incluido.**

Wandleuchte. Diffusor aus geblasenem Triplex-Opalglas, satiniert. Fassung aus weiß lackiertem Metall Ral 9016. Ausführung mit Ziehschalter erhältlich. Ziehgriff aus verchromtem Messing. **Ausführung LED zum led smd und integriert Versorgungsgerät elektronisch.**

Spicchio

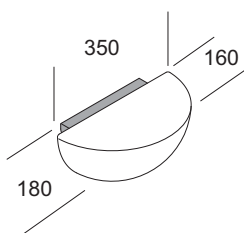

Colore vetro *Glass color*

OP

W_{max}



LUMEN



LUMEN/W



Articolo *Item*

Codice *Code*

Articolo <i>Item</i>	Codice <i>Code</i>	W _{max}	Socket	LUMEN	IP	LUMEN/W	Beam
E27 spicchio	32181	1x77	E27	1320	IP40	17	A
Led spicchio led-W	35671	12,4	led	1700	IP40	137	A
Led spicchio led-N	35681	12,4	led	1700	IP40	137	A
EL spicchio EL	39521	1x26	GX24q-3	1800	IP40	69	A

Spicchio tirante

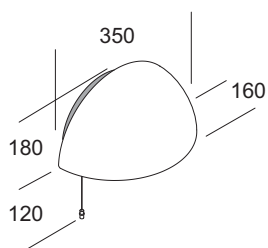

Articolo <i>Item</i>	Codice <i>Code</i>	W _{max}	Socket	LUMEN	IP	LUMEN/W	Beam
E27 spicchio tirante	32271	1x77	E27	1320	IP40	17	A
Led spicchio tirante led-W	35691	12,4	led	1700	IP40	137	A
Led spicchio tirante led-N	35701	12,4	led	1700	IP40	137	A
EL spicchio tirante EL	39531	1x26	GX24q-3	1800	IP40	69	A

Colore vetro *Glass color*

OP

Opale satinato *Satin opal*

● Nuova versione *New version*

Led Equipaggiata con led 3000K - *Equipped with led 3000K*

Led Equipaggiata con led 4000K - *Equipped with led 4000K*

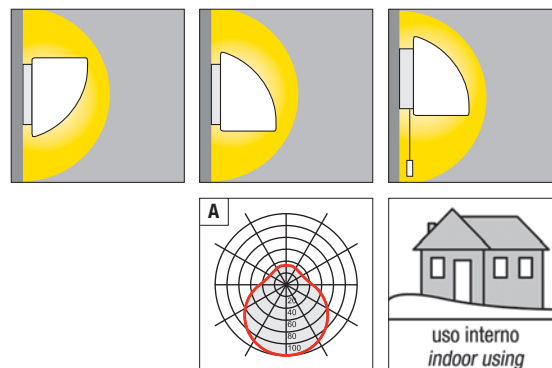



Pallino

Lampada da parete. Diffusore in vetro soffiato opale triplex satinato. Montatura in metallo verniciato bianco ral 9016. Pallino 190 disponibile anche con interruttore a tirante. Pomolo del tirante in ottone cromato. **Versione LED equipaggiata con led smd e alimentatore elettronico incorporato.**

Wall lamp. Diffuser made in blown satin opal triplex glass. Frame in white painted metal ral 9016. Pallino 190 available also with tie rod switch. Knob of tie rod made in chrome metal. **LED version equipped with smd led and electronic driver included.**

Lampe à mur. Diffuseur en verre soufflé opale triplex satiné. Monture réalisée en métal vernie blanc ral 9016. Pallino 190 disponible aussi avec interrupteur à tirant. Poignée de l'interrupteur réalisée en métal chromé. **Version LED équipée avec led smd et ballast électronique incorporé.**

Lámpara de pared. Difusor de vidrio soplado opal triplex satinado. Montadura en metal pintado blanco ral 9016. Pallino 190 disponible también con interruptor de tirante. Pomo del tirante de latón cromado. **Version LED suministrada con led smd y alimentador electrónico incluido.**

Wandleuchte. Diffusor aus geblasenem Triplex-Opalglas, satiniert. Fassung aus weiß lackiertem Metall Ral 9016. Pallino 190 ist auch mit Ziehschalter erhältlich. Ziehgriff aus verchromtem Messing. **Ausführung LED zum led smd und integriert Versorgungsgerät elektronisch.**

Pallino 190

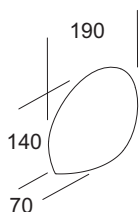

Articolo <i>Item</i>	Colore vetro <i>Glass color</i>		W _{max}		LUMEN		LUMEN/W		
	OP	Codice <i>Code</i>							
E14 pallino 190		32120	1x30	E14	405	IP40	⊕	13	A

Pallino 190 tirante

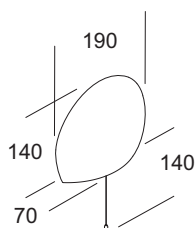

E14 pallino 190 tirante		32121	1x30	E14	405	IP40	⊕	13	A
--------------------------------	--	-------	------	-----	-----	------	---	----	---

Pallino 300

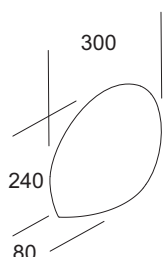

E27 pallino 300		32130	1x77	E27	1320	IP40	⊕	17	A
Led pallino 300 led-W		35711	8,33	led	1090	IP40	⊕	131	A
Led pallino 300 led-N		35721	8,33	led	1090	IP40	⊕	131	A
EL pallino 300 EL		38091	1x26	G24q-3	1800	IP40	⊕	69	A

Colore vetro *Glass color*

OP
Opale satinato *Satin opal*

- Led** Equipaggiata con led 3000K - *Equipped with led 3000K*
- Led** Equipaggiata con led 4000K - *Equipped with led 4000K*

● Nuova versione *New version*

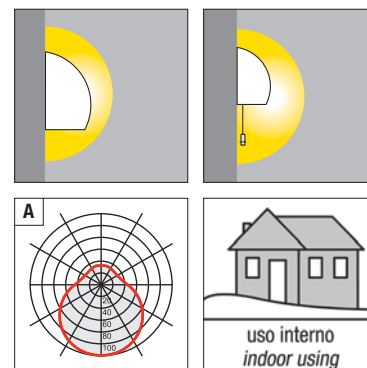



Omega AP

Lampada da parete. Diffusore in vetro satinato. Montatura in tecnopolimero bianco. Fascia in metallo verniciato o con finitura galvanica. **Versione LED equipaggiata con led smd e alimentatore elettronico incorporato.**

Wall lamp. Diffuser made in satin glass. Base made in white techno-polymer. Ring made in painted metal or with galvanic finish. **LED version equipped with smd led and electronic driver included.**

Lampe à mur. Diffuseur en verre satiné. Base réalisée en techno-polymère blanc. Anneau réalisé en métal vernie ou avec finition galvanique. **Version LED équipée avec led smd et ballast électronique incorporé.**

Lámpara de pared. Difusor de vidrio satinado. Montadura en tecnopolímero blanco. Faja de metal pintado o con acabado galvánico. **Version LED suministrada con led smd y alimentador electrónico incluido.**

Wandleuchte. Diffusor aus satiniertem Glas. Fassung aus weißem Technopolymer. Metallband lackiert oder mit galvanischem Finish. **Ausführung LED zum led smd und integriert Versorgungsgerät elektronisch.**

Omega AP

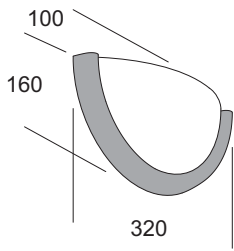

Colore fascia Ring color

Articolo Item	Colore fascia Ring color			W _{max}	E27	LUMEN	IP20	Icona	LUMEN/W	Icona
	BI	NE	CR							
		Codice Code								
E27 omega AP	31091	31097	31096	1x77	E27	1320	IP20	□	17	A
● Led omega AP led-W	35751	35757	35756	6,2	led	850	IP20	⊕	137	A
● Led omega AP led-N	35761	35767	35766	6,2	led	850	IP20	⊕	137	A

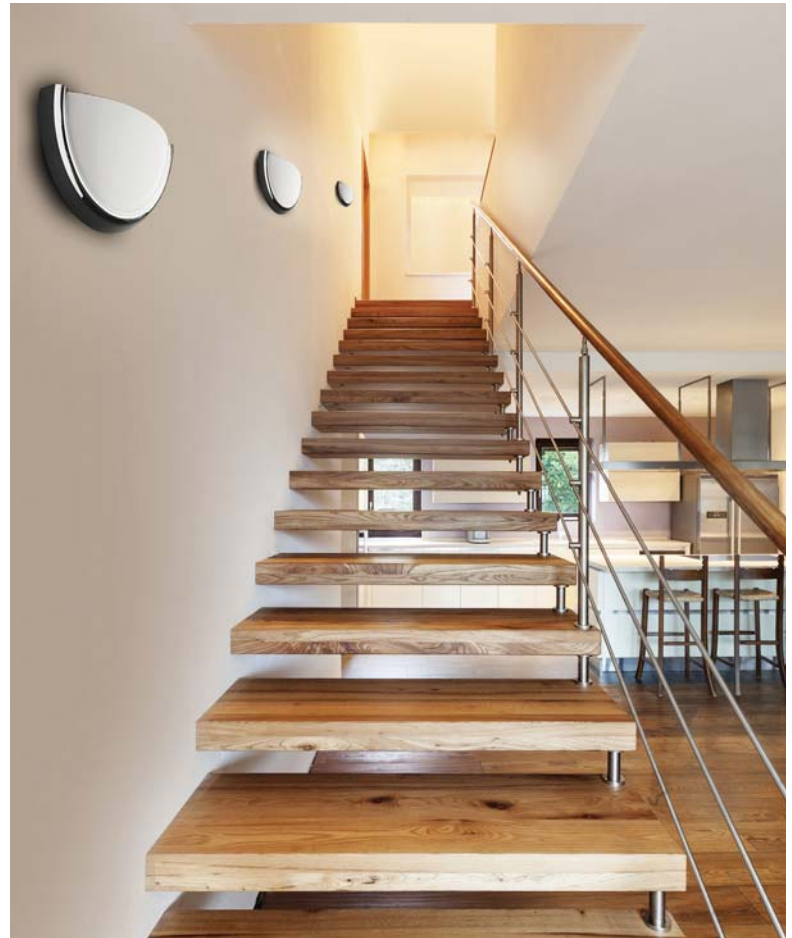

Colore fascia Ring color

BI RAL 9016 Bianco opaco <i>Matt white</i>	NE RAL 9005 Nero opaco <i>Matt black</i>	CR Cromato <i>Chrome</i>
--	--	------------------------------------

● Nuova versione *New version*

- Led** Equipaggiata con led 3000K - *Equipped with led 3000K*
- Led** Equipaggiata con led 4000K - *Equipped with led 4000K*

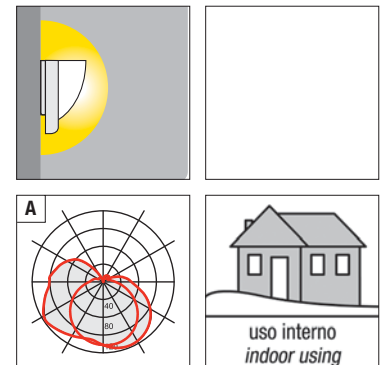



Mega 1

Mega

Lampada da parete. Diffusore in vetro soffiato opale triplex satinato. Montatura in metallo verniciato bianco ral 9016. **Versione LED equipaggiata con led smd e alimentatore elettronico incorporato.**

Wall lamp. Diffuser made in blown satin opal triplex glass. Frame made in white painted metal ral 9016. **LED version equipped with smd led and electronic driver included.**

Lampe à mur. Diffuseur en verre soufflé opale triplex satiné. Monture réalisée en métal vernie blanc ral 9016. **Version LED équipée avec led smd et ballast électronique incorporé.**

Lámpara de pared. Difusor de vidrio soplado opal triplex satinado. Montadura de metal pintado blanco ral 9016. **Version LED suministrada con led smd y alimentador electronico incluido.**

Wandleuchte. Diffusor aus geblasenem Triplex-Opalglas, satiniert. Fassung aus weiß lackiertem Metall Ral 9016. **Ausführung LED zum led smd und integriert Versorgungsgerät elektronisch.**



Mega 2

Mega 1

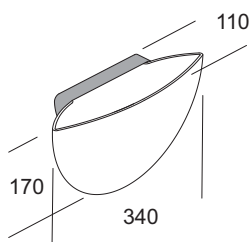

Colore vetro *Glass color*

Articolo <i>Item</i>	OP Codice <i>Code</i>	W _{max}		LUMEN		LUMEN/W		
mega 1	32071	1x77	E27	1320	IP20	⊕	17	A
mega 1 led-W	35771	6,2	led	850	IP20	⊕	137	A
mega 1 led-N	35781	6,2	led	850	IP20	⊕	137	A

Mega 2

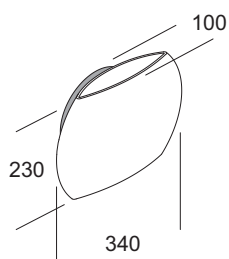

mega 2	32081	1x77	E27	1320	IP20	⊕	17	B
mega 2 led-W	35791	8,33	led	1090	IP20	⊕	131	B
mega 2 led-N	35801	8,33	led	1090	IP20	⊕	131	B

Colore vetro *Glass color*

OP

Opale satinato *Satin opal*

Nuova versione *New version*

Equipaggiata con led 3000K - *Equipped with led 3000K*

Equipaggiata con led 4000K - *Equipped with led 4000K*

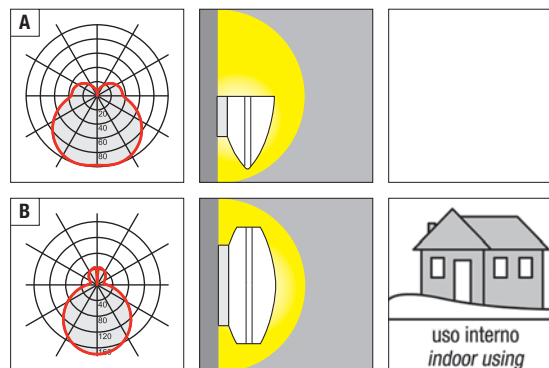



Opera

Lampada da parete. Diffusore in vetro extrachiaro satinato bianco. Diffusore superiore in vetro trasparente satinato. Montatura in metallo verniciato bianco ral 9016. Particolari in metallo cromato. **Versione LED equipaggiata con led smd e alimentatore elettronico incorporato.**

Wall lamp. Diffuser made in extra-clear white satin glass. Upper diffuser made in transparent satin glass. Frame made in white painted metal ral 9016. Metal chrome details. **LED version equipped with smd led and electronic driver included.**

Lampe à mur. Diffuseur en verre extra clair satiné blanc. Diffuseur supérieur en verre transparent satiné. Monture réalisée en métal vernie blanc ral 9016. Détails en métal chromé. **Versión LED equipada con led smd y ballast electrónico incorporado.**

Lámpara de pared. Difusor de vidrio extraclaro satinado blanco. Difusor superior de vidrio claro satinado. Montadura en metal pintado blanco ral 9016. Detalles de metal cromados. **Versión LED suministrada con led smd y alimentador electrónico incluido.**

Wandleuchte. Diffusor aus extra hellem satiniertem weißem Glas. Oberen Diffusor aus satiniertem Glas. Fassung aus weiß lackiertem Metall Ral 9016. Details aus verchromtem Metall. **Ausführung LED zum led smd und integriert Versorgungsgerät elektronisch.**

Opera

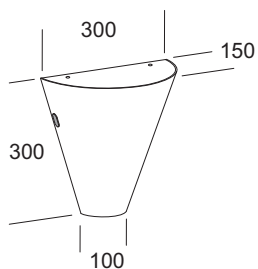

Articolo Item	Colore vetro Glass color		W _{max}		LUMEN		LUMEN/W		
	OP	Codice Code							
opera		32330	1x77	E27	1320	IP20	⊕	17	A
opera led-W		35810	15,5	led	1860	IP20	⊕	120	A
opera led-N		35820	15,5	led	1860	IP20	⊕	120	A
opera EL/26		39150	1x26	G24q-3	1800	IP20	⊕	69	A
opera EL/52		39300	2x26	G24q-3	3600	IP20	⊕	69	A
opera EM		30200	1x26	G24q-3	1800	IP20	⊕	69	A



Colore vetro Glass color

Opale satinato *Satin opal*

Nuova versione *New version*

Equipaggiata con led 3000K - *Equipped with led 3000K*

Equipaggiata con led 4000K - *Equipped with led 4000K*

Emergenza (SA) 1h di serie – 3h a richiesta.
Emergency 1h standard – 3h on request

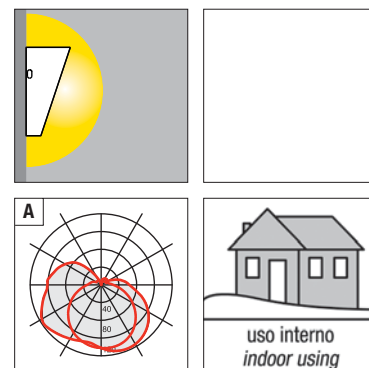



Girotondo

Lampada da parete. Diffusore in vetro soffiato opale triplex satinato. Montatura in metallo verniciato bianco ral 9016. Viti cromate. **Versione LED equipaggiata con led smd e alimentatore elettronico incorporato.**

Wall lamp. Diffuser made in blown satin opal triplex glass. Frame made in white painted metal ral 9016. Chrome screws. **LED version equipped with smd led and electronic driver included.**

Lampe à mur. Diffuseur en verre soufflé opale triplex satiné. Monture réalisée en métal vernie blanc ral 9016. Vis chromé. **Version LED équipée avec led smd et ballast électronique incorporé.**

Lámpara de pared. Difusor de vidrio soplado opal triplex satinado. Montadura de metal pintado blanco ral 9016. Tornillos cromados. **Version LED suministrada con led smd y alimentador electronico incluido.**

Wandleuchte. Diffusor aus geblasenem Triplex-Opalglas satiniert. Fassung aus weiß lackiertem Metall Ral 9016. Verchromte Schrauben. **Ausführung LED zum led smd und integriert Versorgungsgerät elektronisch.**

Girotondo DX

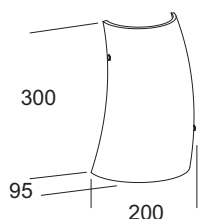
Colore vetro *Glass color*

Articolo <i>Item</i>	OP Codice <i>Code</i>	W _{max}		LUMEN		LUMEN/W	
girotondo DX	32031	1x77	E27	1320	IP20	⊕	17 A
girotondo DX led-W	35831	12,4	led	1700	IP20	⊕	137 A
girotondo DX led-N	35851	12,4	led	1700	IP20	⊕	137 A
girotondo DX EL	38051	1x26	G24q-3	1800	IP20	⊕	69 A

Girotondo SX

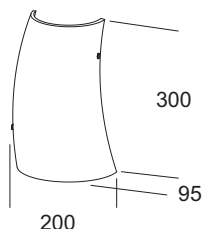

girotondo SX	32041	1x77	E27	1320	IP20	⊕	17 A
girotondo SX led-W	35841	12,4	led	1700	IP20	⊕	137 A
girotondo SX led-N	35861	12,4	led	1700	IP20	⊕	137 A
girotondo SX EL	38061	1x26	G24q-3	1800	IP20	⊕	69 A

Colore vetro *Glass color*

OP

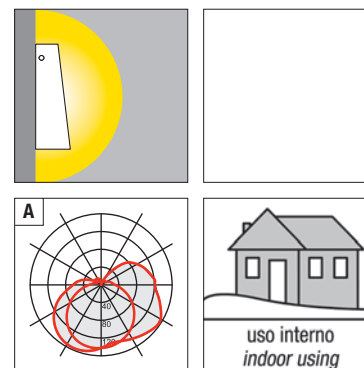
Opale satinato *Satin opal* Equipaggiata con led 3000K - *Equipped with led 3000K* Equipaggiata con led 4000K - *Equipped with led 4000K*● Nuova versione *New version*

Goccia

Lampada da parete. Diffusore in vetro soffiato opale triplex satinato. Montatura in metallo verniciato bianco ral 9016. Viti in vetro trasparente. **Versione LED equipaggiata con led smd e alimentatore elettronico incorporato.**

Wall lamp. Diffuser made in blown satin opal triplex glass. Frame made in white painted metal ral 9016. Screws made in transparent glass. **LED version equipped with smd led and electronic driver included.**

Lampe à mur. Diffuseur en verre soufflé opale triplex satiné. Monture réalisée en métal vernie blanc ral 9016. Vis réalisé en verre transparent. **Version LED équipée avec led smd et ballast électronique incorporé.**

Lámpara de pared. Difusor de vidrio soplado opal triplex satinado. Montadura de metal pintado blanco ral 9016. Tornillos de vidrio transparente. **Version LED suministrada con led smd y alimentador electronico incluido.**

Wandleuchte. Diffusor aus geblasenem Triplex-Opalglas satiniert. Fassung aus weiß lackiertem Metall Ral 9016. Schrauben aus Transparentglas. **Ausführung LED zum led smd und integriert Versorgungsgerät elektronisch.**



Goccia

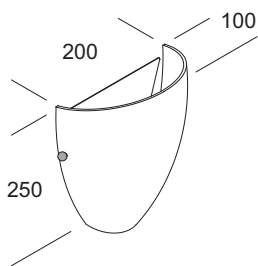

Colore vetro Glass color

Articolo Item	OP Codice Code	W _{max}		LUMEN		LUMEN/W	
E27 goccia	32051	1x77	E27	1320	IP20	17	A
Led goccia led-W	35871	12,4	led	1700	IP20	137	A
Led goccia led-N	35881	12,4	led	1700	IP20	137	A
EL goccia EL	38071	1x26	G24q-3	1800	IP20	69	A



Colore vetro Glass color

OP
Opale satinato *Satin opal*

- Equipaggiata con led 3000K - *Equipped with led 3000K*
- Equipaggiata con led 4000K - *Equipped with led 4000K*

Nuova versione *New version*

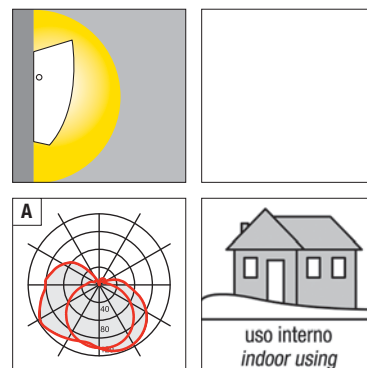

Tegola

Lampada da parete. Diffusore in vetro extrachiaro satinato bianco. Montatura in metallo cromato o verniciato bianco ral 9016.

Versione LED equipaggiata con led smd e alimentatore elettronico incorporato.

Wall lamp. Diffuser made in extra-clear white satin glass. Frame made in chrome plated metal or white painted metal ral 9016.

LED version equipped with smd led and electronic driver included.

Lampe à mur. Diffuseur en verre extra clair satiné blanc. Monture réalisée en métal chromé ou vernie blanc ral 9016.

Version LED équipée avec led smd et ballast électronique incorporé.

Lámpara de pared. Difusor de vidrio extraclaro satinado blanco. Montadura en metal cromado o pintado blanco ral 9016.

Version LED suministrada con led smd y alimentador electronico incluido.

Wandleuchte. Diffusor aus extra hellem satiniertem weißem Glas. Struktur aus verchromtem Metall oder weiß lackiertem Metall Ral 9016.

Ausführung LED zum led smd und integriert Versorgungsgerät elektronisch.



Tegola 40

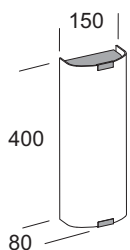

Colore montatura *Frame color*

Articolo <i>Item</i>	Colore montatura <i>Frame color</i>		W _{max}	Icona	LUMEN	Icona	LUMEN/W	Icona	
	CR	BI							
Codice <i>Code</i>									
● Led tegola 40 led-W	35170	35171	23	led	3120	IP20	⊕	136	B
● Led DM tegola 40 DM led-W	35180	35181	23	led	3120	IP20	⊕	136	B
● Led EM tegola 40 EM led-W	30540	30541	23	led	3120	IP20	⊕	136	B
● Led tegola 40 led-N	35190	35191	23	led	3120	IP20	⊕	136	B
● Led DM tegola 40 DM led-N	35200	35201	23	led	3120	IP20	⊕	136	B
● Led EM tegola 40 EM led-N	30550	30551	23	led	3120	IP20	⊕	136	B
EL tegola 40/24 EL	38130	38131	1x24	2G11	1800	IP20	⊕	75	A
tegola 40/2x24 EL	38140	38141	2x24	2G11	3600	IP20	⊕	75	A
DM tegola 40/2x24 DM	38200	38201	2x24	2G11	3600	IP20	⊕	75	A
EM tegola 40/24 EM	30260	30261	1x24	2G11	1800	IP20	⊕	75	A

Tegola 60

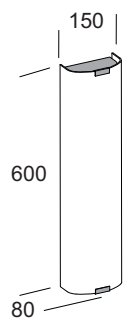

● Led tegola 60 led-W	35210	35211	45,8	led	6260	IP20	⊕	137	B
● Led DM tegola 60 DM led-W	35220	35221	45,8	led	6260	IP20	⊕	137	B
● Led EM tegola 60 EM led-W	30560	30561	45,8	led	6260	IP20	⊕	137	B
● Led tegola 60 led-N	35230	35231	45,8	led	6260	IP20	⊕	137	B
● Led DM tegola 60 DM led-N	35240	35241	45,8	led	6260	IP20	⊕	137	B
● Led EM tegola 60 EM led-N	30570	30571	45,8	led	6260	IP20	⊕	137	B
EL tegola 60/55 EL	38160	38161	1x55	2G11	4800	IP20	⊕	87	A
tegola 60/2x55 EL	38170	38171	2x55	2G11	9600	IP20	⊕	87	A
DM tegola 60/2x55 DM	38210	38211	2x55	2G11	9600	IP20	⊕	87	A
EM tegola 60/55 EM	30270	30271	1x55	2G11	4800	IP20	⊕	87	A

Colore montatura *Frame color*

CR Cromato *Chrome* **BI** RAL 9016 Bianco opaco *Matt white*

● Nuova versione *New version*

- Led** Equipaggiata con led 3000K - *Equipped with led 3000K*
- Led** Equipaggiata con led 4000K - *Equipped with led 4000K*
- Led DM** **Led DM** **DM** Dimmerabile PUSH/DALI *Dimmable PUSH/DALI (info page10)*
- Led EM** **Led EM** **EM** Emergenza (SA) 1h di serie - 3h a richiesta *Emergency 1h standard - 3h on request*

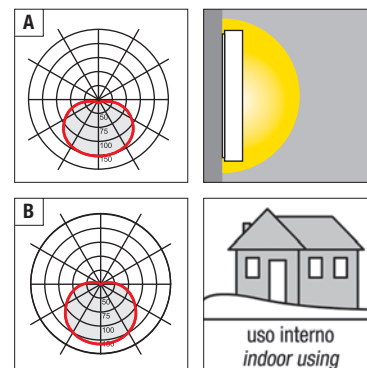



Domo

Lampada da parete orientabile. Struttura in alluminio estruso con particolari in pressofusione di alluminio, verniciatura in polvere poliestere con trattamento di fosfatazione. Guarnizioni in silicone. Giunto orientabile in ottone cromato. Versioni EL e MD con diffusore in vetro temperato trasparente e parabola riflettente simmetrica in alluminio bugnato lucido. **Versioni LED con diffusore in vetro temperato sabbiato internamente, parabola in metallo verniciato bianco, led smd e alimentatore elettronico incorporato.**

Adjustable wall lamp. Structure made in extruded aluminium and die casting aluminium parts. Polyester paint with phosphate treatment. Gasket made in silicone rubber. Adjustable joint made in chrome brass. Version EL and MD with diffuser made in tempered transparent glass and symmetric inside reflector made in rusticated bright aluminium. **LED version with diffuser made in tempered glass with sandblasted inside surface, reflector in white metal painted, smd led and electronic driver included.**

Lampe à mur réglable. Structure réalisée en extrusion d'aluminium avec parties en fonte d'aluminium. Vernis polyester traitement de phosphatation. Joint en gomme de silicone. Joint orientable réalisé en cuivre chromé. Version EL et MD avec diffuseur en verre tempère transparent et réflecteur intérieur symétrique réalisé en aluminium brillant. **Version LED avec diffuseur en verre tempéré et sablé à l'intérieur, réflecteur en métal verni blanc, led smd et ballast électronique incorporé.**

Lámpara de pared giratoria. Estructura de aluminio extrudido con detalles fundidos a presión de aluminio, pintura en polvo poliéster con tratamiento de fosfatación. Junta de protección de silicona. Junta de orientación ajustable de latón cromado. Versión EL y MD con difusor de vidrio templado transparente y parábola reflectante simétrica de aluminio despulido brillante. **Versión LED con difusor de vidrio templado arenado internamente, parábola de metal pintado blanco, led smd y alimentador electrónico incluido.**

Schwenkbare Wandleuchte. Struktur aus Aluminium Extrusion mit Einzelteilen aus Aludruckguss, Lackierung aus Polyesterpulver mit Phosphatierung. Silikondichtungen. Schwenkbares Gelenk aus verchromtem Messing. Ausführung EL und MD mit Diffusor aus temperiertem Transparentglas und Symmetrischer reflektierender Parabolspiegel aus bossiert glänzenden Aluminium. **Ausführung LED mit Diffusor aus temperiertem Glas innen sandgestrahlt, Parabolspiegel aus weiß lackiertem Metall, led smd und integriert Versorgungsgerät elektronisch.**

Domo 130

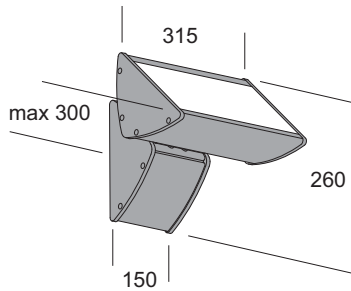

Articolo Item	Colore struttura Structure color				W _{max}	LUMEN	IP	LUMEN/W	Icon
	AT	BI	GR	RU					
● Led domo 130 led-W	35897	35891	35896	35898	23	led	3120	IP40	⊕ 136 C
● domo 130S led-W	35907	35901	35906	35908	46	led	6240	IP40	⊕ 136 C
● Led DM domo 130S DM led-W	35917	35911	35916	35918	46	led	6240	IP40	⊕ 136 C
● Led domo 130 led-N	35927	35921	35926	35928	23	led	3120	IP40	⊕ 136 C
● domo 130S led-N	35937	35931	35936	35938	46	led	6240	IP40	⊕ 136 C
● Led DM domo 130S DM led-N	35947	35941	35946	35948	46	led	6240	IP40	⊕ 136 C
EL domo 130/2x42 EL	39507	39501	39506	39508	2x42(a)	Gx24q-4	6400	IP40	⊕ 76 A
MDEL domo 130/70 MD-EL	35017	35011	35016	35018	1x70	Rx7s	7000	IP40	⊕ 100 B
● domo 130/150 MD-EL	35957	35951	35956	35958	1x150	Rx7s	15000	IP40	⊕ 100 B

Domo 300

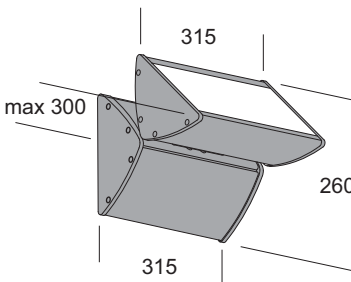

● Led EM domo 300 EM led-W	30847	30841	30846	30848	23	led	3120	IP40	⊕ 136 C
● domo 300S EM led-W	30857	30851	30856	30858	46	led	6240	IP40	⊕ 136 C
● Led EM domo 300 EM led-N	30867	30861	30866	30868	23	led	3120	IP40	⊕ 136 C
● domo 300S EM led-N	30877	30871	30876	30878	46	led	6240	IP40	⊕ 136 C
EM domo 300/2x42 EM	30187	30181	30186	30188	2x42(a)	Gx24q-4	6400	IP40	⊕ 76 A

Colore struttura Structure color

● Nuova versione New version

BI RAL 9016 Bianco gofrato Embossed white	GR RAL 9006 Grigio gofrato Embossed grey	AT RAL 7016 Antracite gofrato Embossed anthracite	● RU Ruggine Rust
---	--	---	-----------------------------

Led Equipaggiata con led 3000K - Equipped with led 3000K

Led Equipaggiata con led 4000K - Equipped with led 4000K

Led DM **Led DM** Dimmerabile PUSH/DALI
Dimmable PUSH/DALI (info page 10)

Led EM **Led EM** **EM** Emergenza (SA) 1h di serie – 3h a richiesta
Emergency 1h standard – 3h on request

(a) Equipaggiato con alimentatore multipotenza per l'utilizzo di lampade da 26W-32W o 42W.
Equipped with multi-power ballast to use bulbs of 26W-32W or 42W.

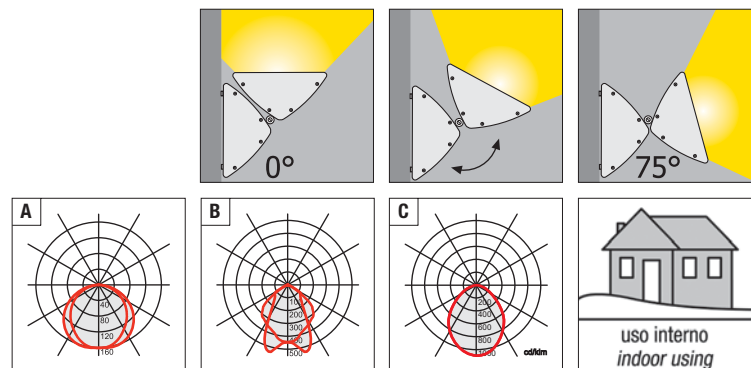



Equos

Lampada da parete. Diffusore in vetro temperato trasparente. Struttura in alluminio estruso con particolari in pressofusione di alluminio, verniciatura in polvere poliestere con trattamento di fosfatazione. Viti in acciaio inox. Guarnizioni in silicone. **Versione led equipaggiata con LED COB e alimentatore elettronico incorporato.**

Wall lamp. Diffuser made in tempered transparent glass. Structure made in extruded aluminium and die casting aluminium parts with polyester paint and phosphate treatment. Inox steel screws. Gaskets made in silicone rubber. **LED version equipped with COB LED and electronic gear included.**

Lampe à mur. Diffuseur en verre trempé transparent. Structure réalisée en extrusion d'aluminium avec parties en fonte d'aluminium. Vernis polyester avec traitement de phosphatation. Vis en acier inox. Joint en gomme de silicone. **Versión led equipada con LED COB y ballast electrónico incorporado.**

Lámpara de pared. Difusor de vidrio templado transparente. Estructura de aluminio extrudido con detalles Fundidos a presión de aluminio, pintura en polvo poliéster con tratamiento de fosfatación. Tornillos de acero inoxidable. Junta de protección de silicona. **Versión led suministrada con LED COB y alimentador electrónico incorporado.**

Wandleuchte. Diffusor aus temperiertem Transparentglas. Struktur aus Aluminium extrusion mit Einzelteilen aus Aludruckguss, Lackierung aus Polyester Pulver Mit Phosphatierung. Schrauben aus Edelstahl. Silikondichtungen. **Ausführung LED zum LED COB und eingebautem elektronischem Versorgungsgerät.**



14 applique interni/esterni
wall lights indoor/outdoor

150 plafoniere interni/esterni
ceiling bowls indoor/outdoor













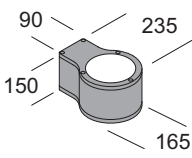
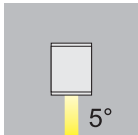

248 testaletto
bed head units

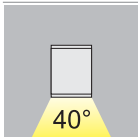
258 sospensioni
suspensions

344 lampade
lamps

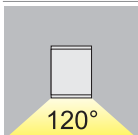
384 lampioni ed incassi
bollards & recessed lights

450 indice
index

Equos 1 Led	Articolo Item	Colore struttura Structure color				W _{max}		LUMEN		LUMEN/W		
		AT	BI	GR	RU							Codice Code
 	 equos 1 led-W/5°	55377	55371	55376	55378	6	led	500	IP65		84	A
	 equos 1 led-N/5°	55307	55301	55306	55308	6	led	500	IP65		84	A
	 equos 1 led-W/40°	55387	55381	55386	55388	16,5	led	2000	IP65		121	B
	 equos 1 led-N/40°	55317	55311	55316	55318	16,5	led	2000	IP65		121	B
	 equos 1 led-W/120°	55397	55391	55396	55398	16,5	led	2000	IP65		121	C
	 equos 1 led-N/120°	55327	55321	55326	55328	16,5	led	2000	IP65		121	C

Colore struttura Structure color

AT RAL 7016

Antracite gofrato Embossed anthracite

BI RAL 9016

Bianco gofrato Embossed white

GR RAL 9006

Grigio gofrato Embossed grey

RU

Ruggine Rust

● Nuova versione New version

 Equipaggiata con led 3000K - Equipped with led 3000K

 Equipaggiata con led 4000K - Equipped with led 4000K

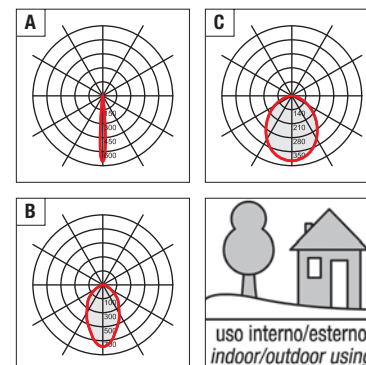

Equos 2 Led

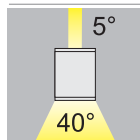
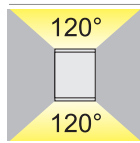
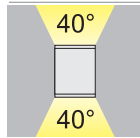
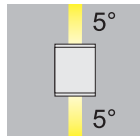
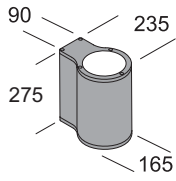

Colore struttura Structure color

Articolo Item

AT BI GR RU W_{max}



LUMEN



LUMEN/W



Articolo Item	AT	BI	GR	RU	W _{max}	LUMEN	LUMEN/W	
● Led equos 2 led-W/5°	55407	55401	55406	55408	12	1000	84	A
● Led equos 2 led-N/5°	55337	55331	55336	55338	12	1000	84	A
● Led equos 2 led-W/40°	55417	55411	55416	55418	33	4000	121	B
● Led equos 2 led-N/40°	55347	55341	55346	55348	33	4000	121	B
● Led equos 2 led-W/120°	55427	55421	55426	55428	33	4000	121	C
● Led equos 2 led-N/120°	55357	55351	55356	55358	33	4000	121	C
● Led equos 2 led-W/MIX	55437	55431	55436	55438	22,5	2500	111	D
● Led equos 2 led-N/MIX	55367	55361	55366	55368	22,5	2500	111	D

Colore struttura Structure color

● Nuova versione New version

AT RAL 7016
Antracite gofrato Embossed anthracite

BI RAL 9016
Bianco gofrato Embossed white

GR RAL 9006
Grigio gofrato Embossed grey

● **RU**
Ruggine Rust

Led Equipaggiata con led 3000K - Equipped with led 3000K

Led Equipaggiata con led 4000K - Equipped with led 4000K

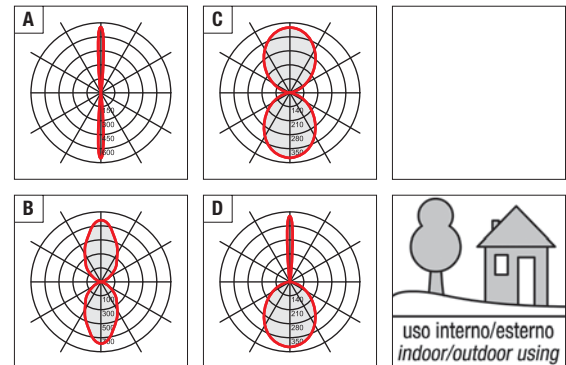

Colore struttura Structure color

Articolo Item

AT

BI

GR

RU

W_{max}



LUMEN



LUMEN/W



Codice Code

Equos 1

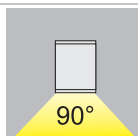
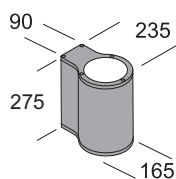

EL	equos 1/26 EL	64137	64131	64136	64138	1x26	GX24q-3	1800	IP65	□	69	B
	equos 1/42 EL	64147	64141	64146	64148	1x42(a)	GX24q-4	3200	IP65	□	76	B

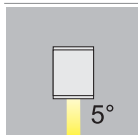

MDEL	equos 1L/35 MD-EL	64447	64441	64446	64448	1x35	G12	3700	IP65	⊕	106	A
------	--------------------------	-------	-------	-------	-------	------	-----	------	------	---	-----	---

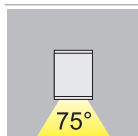

MDEL	equos 1/35 MD-EL	64457	64451	64456	64458	1x35	G12	3700	IP65	⊕	106	C
	equos 1/70 MD-EL	64467	64461	64466	64468	1x70	G12	7400	IP65	⊕	106	C
	equos 1/150 MD-EL	64477	64471	64476	64478	1x150	G12	15100	IP65	⊕	101	C

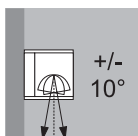

Fascio orientabile
Adjustable Beam

Equos 1 Long

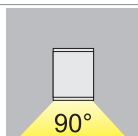
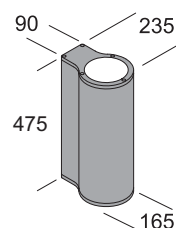

EL	equos 1/42 EL LONG	64157	64151	64156	64158	1x42(a)	GX24q-4	3200	IP65	□	76	B
EM	equos 1 EM	60157	60151	60156	60158	1x42(a)	GX24q-4	3200	IP65	□	76	B

Colore struttura Structure color

● Nuova versione New version

AT RAL 7016

Antracite goffrato Embossed anthracite

BI RAL 9016

Bianco goffrato Embossed white

GR RAL 9006

Grigio goffrato Embossed grey

● RU

Ruggine Rust

EM Emergenza (SA) 1h di serie – 3h a richiesta.
Emergency 1h standard – 3h on request

(a) Equipaggiato con alimentatore multipotenza per l'utilizzo di lampade da 26W-32W o 42W
Equipped with multi-power ballast to use bulbs of 26W-32W or 42W

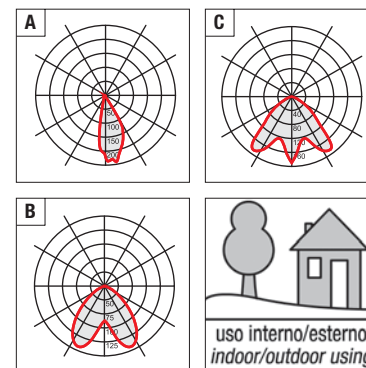

Equos 2

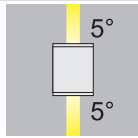
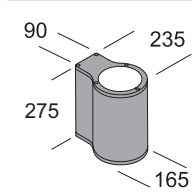

Articolo Item	AT	BI	GR	RU	W _{max}	LUMEN	IP	LUMEN/W	Icon
● MDEL equos 2L/35 MD-EL	64487	64481	64486	64488	1x35	G12 3700	IP65	⊕ 106	A

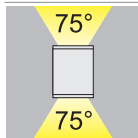

● MDEL equos 2/70 MD-EL	64497	64491	64496	64498	1x70	G12 7400	IP65	⊕ 106	B
● equos 2/150 MD-EL	64507	64501	64506	64508	1x150	G12 15100	IP65	⊕ 101	B

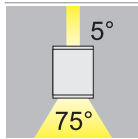

● MDEL equos MIX 70 MD-EL	64517	64511	64516	64518	1x70	G12 7400	IP65	⊕ 106	C
----------------------------------	-------	-------	-------	-------	------	----------	------	-------	---

Equos 2

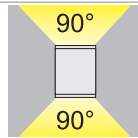
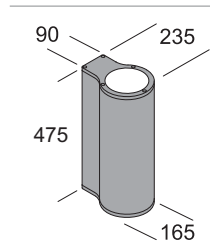

EL equos 2/2x42 EL	64167	64161	64166	64168	2x42(a)	GX24q-4 6400	IP65	⊕ 76	D
EM equos 2 EM	60167	60161	60166	60168	2x42(a)	GX24q-4 6400	IP65	⊕ 76	D

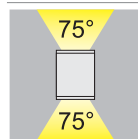

● MDEL equos 2/2x35 MD-EL	64527	64521	64526	64528	2x35	G12 7400	IP65	⊕ 106	E
● equos 2/2x70 MD-EL	64537	64531	64536	64538	2x70	G12 14800	IP65	⊕ 106	E
● equos 2/2x150 MD-EL	64547	64541	64546	64548	2x150	G12 30200	IP65	⊕ 101	E

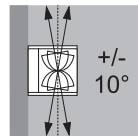

Fascio orientabile
Adjustable Beam

Colore struttura Structure color

AT RAL 7016 Antracite gofrato Embossed anthracite	BI RAL 9016 Bianco gofrato Embossed white	GR RAL 9006 Grigio gofrato Embossed grey	● RU Ruggine Rust
---	---	--	-----------------------------

EM Emergenza (SA) 1h di serie – 3h a richiesta.
Emergency 1h standard – 3h on request

(a) Equipaggiato con alimentatore multipotenza per l'utilizzo di lampade da 26W-32W o 42W
Equipped with multi-power ballast to use bulbs of 26W-32W or 42W

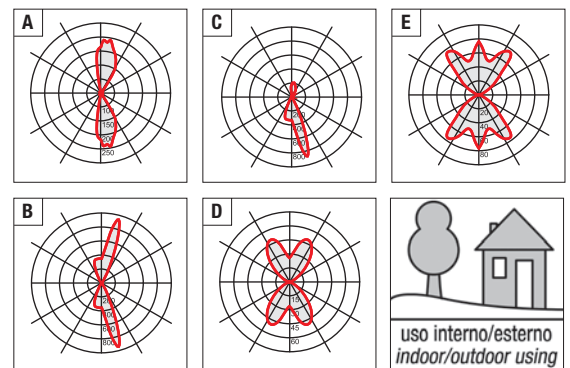



Rol

Lampada da parete. Diffusore in vetro temperato sabbiato internamente. Struttura in alluminio estruso con particolari in pressofusione di alluminio, verniciatura in polvere poliestere con trattamento di fosfatazione. Viti in acciaio inox. Guarnizioni in silicone. **Equipaggiata con LED COB e alimentatore elettronico incorporato.**

Wall lamp. Diffuser made in tempered glass with sandblasted inside surface. Structure made in extruded aluminium and die casting aluminium parts with polyester paint and phosphate treatment. Inox steel screws. Gaskets made in silicone rubber. **Led version equipped with COB LED and electronic gear included.**

Lampe à mur. Diffuseur en verre tempéré et sablé à l'intérieur. Structure réalisée en extrusion d'aluminium avec parties en fonte d'aluminium. Vernis polyester avec traitement de phosphatation. Vis en acier inox. Joint en gomme de silicone. **Versión led equipada con LED COB et ballast électronique incorporé.**

Lámpara de pared. Difusor de vidrio templado arenado internamente. Estructura de aluminio extrudido con detalles Fundidos a presión de aluminio, pintura en polvo poliéster con tratamiento de fosfatación. Tornillos de acero inoxidable. Junta de protección de silicona. **Versión led suministrada con LED COB y alimentador electrónico incorporado.**

Wandleuchte. Diffusor aus temperiertem Glas innen sandgestrahlt. Struktur aus Aluminium extrusion mit Einzelteilen aus Aludruckguss, Lackierung aus Polyester Pulver Mit Phosphatierung. Schrauben aus Edelstahl. Silikondichtungen. **Ausführung LED zum LED COB und eingebautem elektronischem Versorgungsgerät.**

Colore struttura Structure color

Rol 1

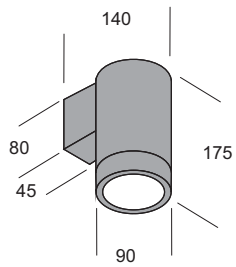

Articolo Item	Colore struttura Structure color				W _{max}	LUMEN	IP	LUMEN/W	Icon		
	AT	BI	GR	RU							
	Codice Code										
Led rol 1 led-W	54807	54801	54806	54808	9,3	led	975	IP54	⊕	105	A
Led rol 1 led-N	54817	54811	54816	54818	9,3	led	975	IP54	⊕	105	A

Rol 2

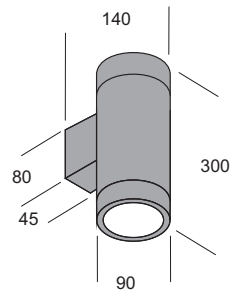

Led rol 2 led-W	54827	54821	54826	54828	18,6	led	1950	IP54	⊕	105	B
Led rol 2 led-N	54837	54831	54836	54838	18,6	led	1950	IP54	⊕	105	B

Colore struttura Structure color

BI RAL 9016 Bianco gofrato Embossed white	AT RAL 7016 Antracite gofrato Embossed anthracite	GR RAL 9006 Grigio gofrato Embossed grey	RU Ruggine Rust
---	---	--	---------------------------

- Led Equipaggiata con led 3000K - Equipped with led 3000K
- Led Equipaggiata con led 4000K - Equipped with led 4000K

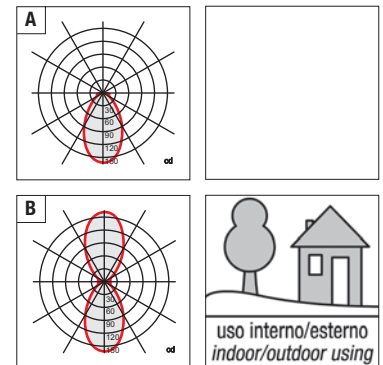

Plan

Lampada da parete. Struttura in alluminio estruso con particolari in pressofusione di alluminio, verniciatura in polvere poliestere con trattamento di fosfatazione. Viti in acciaio inox. Guarnizioni in silicone. Diffusore in policarbonato colore anice e parabola in metallo verniciato bianco. Versione 20 e 30 LED con diffusore in vetro temperato sabbiato internamente. Versioni 30 EL e 30 DM con diffusore in vetro trasparente temperato e parabola riflettente simmetrica in alluminio bugnato lucido. **Versione LED equipaggiata con led smd e alimentatore elettronico incorporato.**

Wall lamp. Structure made in extruded aluminium and die casting aluminium parts with polyester paint and phosphate treatment. Inox steel screws. Gasket made in silicone rubber. Diffuser made in polycarbonate colour anise and inside reflector made in white painted metal. Version 20 and 30 LED with diffuser made in tempered glass with sandblasted inside surface. Version 30 EL and 30 DM with diffuser made in transparent tempered glass and symmetric inside reflector made in rusticated bright aluminium. **LED version equipped with smd led and electronic driver included.**

Lampe à mur. Structure réalisée en extrusion d'aluminium avec parties en fonte d'aluminium. Vernis polyester traitement de phosphatation. Vis en acier inox. Joint en gomme de silicone. Diffuseur en polycarbonate couleur anis et réflecteur intérieur en métal verni blanc. Version 20 et 30 LED avec diffuseur en verre tempéré et sablé à l'intérieur. Version 30 EL et 30 DM avec diffuseur en verre transparent tempéré et réflecteur intérieur symétrique réalisé en aluminium brillant. **Version LED équipée avec led smd et ballast électronique incorporé.**

Lámpara de pared. Estructura de aluminio extrudido con detalles fundidos a presión de aluminio, pintura en polvo poliéster con tratamiento de fosfatación. Tornillos de acero inoxidable. Junta de protección de silicona. Difusor de policarbonato color anís y parábola reflectante de metal pintado blanco. Version 20 y 30 LED con difusor de vidrio templado arenado internamente. Version 30 EL y 30 DM con difusor de vidrio transparente templado y parábola reflectante simétrica de aluminio despulido brillante. **Version LED suministrada con led smd y alimentador electrónico incluido.**

Wandleuchte. Struktur aus Aluminium extrusion mit Einzelteilen aus Aludruckguss, Lackierung aus Polyester Pulver mit Phosphatierung. Schrauben aus rostfreiem Stahl. Silikondichtungen. Diffusor aus anisfarbenem Polycarbonat und Parabolspiegel aus weiß lackiertem Metall. Ausführung 20 und 30 LED mit Diffusor aus temperiertem Glas innen sandgestrahlt. Ausführung 30 EL und 30 DM mit Diffusor aus temperiertem Transparentglas und Symmetrischer reflektierender Parabolspiegel aus bossiert glänzenden Aluminium. **Ausführung LED zum led smd und integriert Versorgungsgerät elektronisch.**



Plan 20

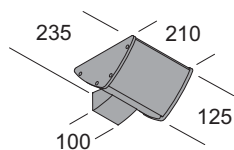

Articolo Item	Colore struttura Structure color				W _{max}	E	LUMEN	IP	LUMEN/W	Icon	
	AT	BI	GR	RU							
	Codice Code										
E27 plan 20	62197	62191	62196	62198	1x46	E27	700	IP65	⊕	15	A
● Led plan 20 led-W	54007	54001	54006	54008	12,4	led	1700	IP65	⊕	137	B
● Led plan 20 led-N	54017	54011	54016	54018	12,4	led	1700	IP65	⊕	137	B
EL plan 20 EL	64287	64281	64286	64228	1x26	GX24q-3	1800	IP65	⊕	69	A

Plan 30

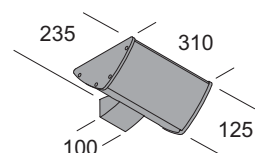

E27 plan 30	62017	62011	62016	62018	1x46	E27	700	IP65	⊕	15	A
● Led plan 30 led-W	54027	54021	54026	54028	23	led	3120	IP65	⊕	136	B
● plan 30S led-W	54037	54031	54036	54038	46	led	6240	IP65	⊕	136	B
● Led DM plan 30S DM led-W	54047	54041	54046	54048	46	led	6240	IP65	⊕	136	B
● Led plan 30 led-N	54057	54051	54056	54058	23	led	3120	IP65	⊕	136	B
● plan 30S led-N	54067	54061	54066	54068	46	led	6240	IP65	⊕	136	B
● Led DM plan 30S DM led-N	54077	54071	54076	54078	46	led	6240	IP65	⊕	136	B
EL plan 30/2x42 EL	63667	63661	63666	63668	2x42(a)	GX24q-4	6400	IP65	⊕	76	C
● DM plan 30/2x42 DM	64557	64551	64556	64558	2x42(a)	GX24q-4	6400	IP65	⊕	76	C

Colore struttura Structure color

● Nuova versione New version

AT RAL 7016 Antracite gofrato Embossed anthracite	BI RAL 9016 Bianco gofrato Embossed white	GR RAL 9006 Grigio gofrato Embossed grey	● RU Ruggine Rust
---	---	--	-----------------------------

- Led** Equipaggiata con led 3000K - Equipped with led 3000K
- Led** Equipaggiata con led 4000K - Equipped with led 4000K
- Led DM** **Led DM** **DM** Dimmerabile PUSH/DALI
Dimmable PUSH/DALI (info page 10)

(a) Equipaggiato con alimentatore multipotenza per l'utilizzo di lampade da 26W-32W o 42W.
Equipped with multi-power ballast to use bulbs of 26W-32W or 42W.

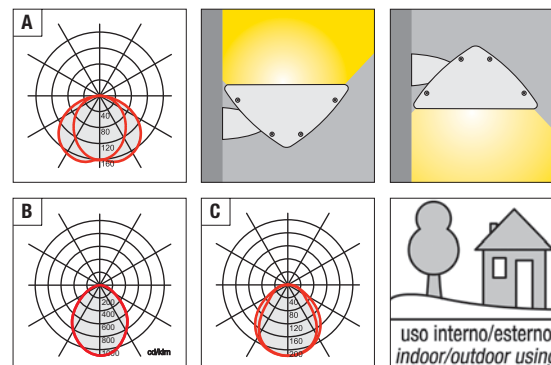

Plan 60

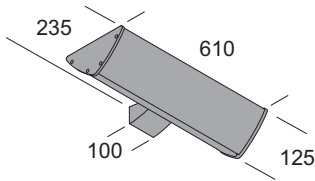

Colore struttura Structure color

Articolo Item	Colore struttura Structure color				W _{max}	LUMEN	IP	LUMEN/W	Icona
	AT	BI	GR	RU					
● Led plan 60 led-W	54087	54081	54086	54088	45,8	led	6260	IP65	⊕ 137 C
● Led DM plan 60 DM led-W	54097	54091	54096	54098	45,8	led	6260	IP65	⊕ 137 C
● Led EM plan 60 EM led-W	50067	50061	50066	50068	45,8	led	6260	IP65	⊕ 137 C
● Led plan 60 led-N	54107	54101	54106	54108	45,8	led	6260	IP65	⊕ 137 C
● Led DM plan 60 DM led-N	54117	54111	54116	54118	45,8	led	6260	IP65	⊕ 137 C
● Led EM plan 60 EM led-N	50077	50071	50076	50078	45,8	led	6260	IP65	⊕ 137 C
EL plan 60/2x24 EL	63237	63231	63236	63238	2x24	G5	4000	IP65	⊕ 83 A
plan 60/2x36 EL	64317	64311	64316	64318	2x36	2G11	5800	IP65	⊕ 81 B
plan 60/2x55 EL	63257	63251	63256	63258	2x55	2G11	9600	IP65	⊕ 87 B
● DM plan 60/2x36 DM	64567	64561	64566	64568	2x36	2G11	5800	IP65	⊕ 81 B
● plan 60/2x55 DM	64577	64571	64576	64578	2x55	2G11	9600	IP65	⊕ 87 B
EM plan 60 EM/72	60187	60181	60186	60188	2x36	2G11	5800	IP65	⊕ 81 B

Plan 120

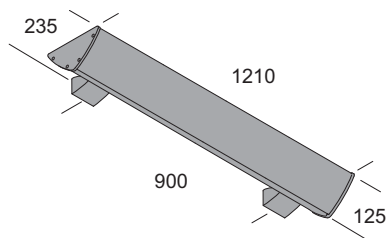

● Led plan 120 led-W	54127	54121	54126	54128	91,6	led	12520	IP65	⊕ 137 C
● Led DM plan 120 DM led-W	54137	54131	54136	54138	91,6	led	12520	IP65	⊕ 137 C
● Led plan 120 led-N	54147	54141	54146	54148	91,6	led	12520	IP65	⊕ 137 C
● Led DM plan 120 DM led-N	54157	54151	54156	54158	91,6	led	12520	IP65	⊕ 137 C
EL plan 120/2x54 EL	63297	63291	63296	63298	2x54	G5	10000	IP65	⊕ 93 A
● DM plan 120/2x54 DM	64587	64581	64586	64588	2x54	G5	10000	IP65	⊕ 93 A

Colore struttura Structure color

● Nuova versione New version

AT RAL 7016
Antracite gofrato Embossed anthracite

BI RAL 9016
Bianco gofrato Embossed white

GR RAL 9006
Grigio gofrato Embossed grey

● **RU**
Ruggine Rust

Led Equipaggiata con led 3000K - Equipped with led 3000K

Led Equipaggiata con led 4000K - Equipped with led 4000K

Led DM **Led DM** **DM** Dimmerabile PUSH/DALI
Dimmable PUSH/DALI (info page 10)

Led EM **Led EM** **EM** Emergenza (SA) 1h di serie – 3h a richiesta.
Emergency 1h standard – 3h on request

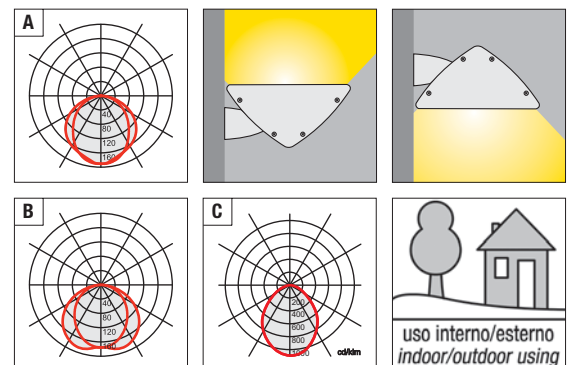



Biplan

Lampada da parete per illuminazione di ambienti con luce diretta e indiretta. Struttura in alluminio estruso con particolari in pressofusione di alluminio, verniciatura in polvere poliesteri con trattamento di fosfatazione. Viti in acciaio inox. Guarnizioni in silicone. Diffusore in policarbonato colore anice e parabola in metallo verniciato bianco. Cablaggio per luce diretta e indiretta con accensione separata. **Versione LED equipaggiata con led smd e alimentatore elettronico incorporato.**

Wall lamp to illuminate with direct and indirect light. Structure made in extruded aluminium and die casting aluminium parts with polyester paint and phosphate treatment. Inox steel screws. Gasket made in silicone rubber. Diffuser made in polycarbonate colour anise and inside reflector made in white painted metal. Cabled with double separate lights for direct and indirect light. **LED version equipped with smd led and electronic driver included.**

Lampe à mur pour éclairage avec lumière directe et indirecte. Structure réalisée en extrusion d'aluminium avec parties en fonte d'aluminium. Vernis polyester traitement de phosphatation. Vis en acier inox. Joint en gomme de silicone. Diffuseur en polycarbonate couleur anis et réflecteur intérieur en métal verni blanc. Câblée avec allumage séparée pour lumière directe et indirecte. **Version LED équipée avec led smd et ballast électronique incorporé.**

Lámpara de pared para iluminación de ambientes con luz directa y indirecta. Estructura de aluminio extrudido con detalles fundidos a presión de aluminio, pintura en polvo poliéster con tratamiento de fosfatación. Tornillos de acero inoxidable. Junta de protección de silicona. Difusor de policarbonato color anís y parábola reflectante de metal pintado blanco. Lámpara cableada con encendido separado por luz directa e indirecta. **Version LED suministrada con led smd y alimentador electrónico incluido.**

Wandleuchte zur Beleuchtung von Räumen mit direktem und diffusem Licht. Struktur aus Aluminium extrusion mit Einzelteilen aus Aludruckguss, Lackierung aus Polyester Pulver mit Phosphatierung. Schrauben aus rostfreiem Stahl. Silikondichtungen. Diffusor aus anisfarbenem Polycarbonat und Parabolspiegel aus weiß lackiertem Metall. Verdrahtung für direktes und indirektes Licht mit getrennter einschalten. **Ausführung LED zum led smd und integriert Versorgungsgerät elektronisch.**

Biplan 30

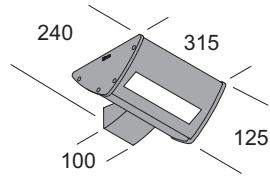

Colore struttura Structure color

Articolo Item

AT BI GR RU
Codice Code

W_{max}



LUMEN



LUMEN/W



● Led	biplan 30 led-W	54167	54161	54166	54168	23 + 11,5	led	4680	IP65	⊕	136	A
● Led DM	biplan 30 DM led-W	54177	54171	54176	54178	23 + 11,5	led	4680	IP65	⊕	136	A
● Led	biplan 30 led-N	54187	54181	54186	54188	23 + 11,5	led	4680	IP65	⊕	136	A
● Led DM	biplan 30 DM led-N	54197	54191	54196	54198	23 + 11,5	led	4680	IP65	⊕	136	A
EL	biplan 30/3x18 EL	64187	64181	64186	64188	2x18+1x18	2G11	3600	IP65	⊕	67	A

Biplan 60

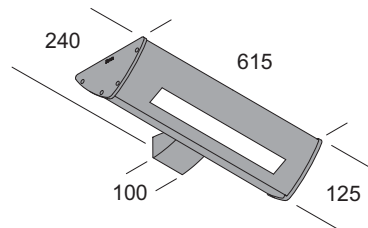

● Led	biplan 60 led-W	54207	54201	54206	54208	45,8 + 22,9	led	9390	IP65	⊕	137	B
● Led DM	biplan 60 DM led-W	54217	54211	54216	54218	45,8 + 22,9	led	9390	IP65	⊕	137	B
● Led	biplan 60 led-N	54227	54221	54226	54228	45,8 + 22,9	led	9390	IP65	⊕	137	B
● Led DM	biplan 60 DM led-N	54237	54231	54236	54238	45,8 + 22,9	led	9390	IP65	⊕	137	B
EL	biplan 60/3x24 EL	64127	64121	64126	64128	2x24 + 1x24	G5	6000	IP65	⊕	75	B



Colore struttura Structure color

AT RAL 7016
Antracite gofrato Embossed anthracite

BI RAL 9016
Bianco gofrato Embossed white

GR RAL 9006
Grigio gofrato Embossed grey

● **RU**
Ruggine Rust

Led Equipaggiata con led 3000K - Equipped with led 3000K

Led Equipaggiata con led 4000K - Equipped with led 4000K

Led DM **Led DM** Dimmerabile PUSH/DALI
Dimmable PUSH/DALI (info page 10)

● Nuova versione New version

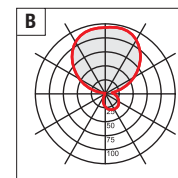
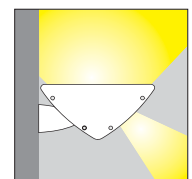
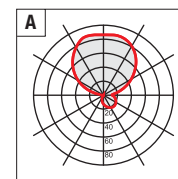

uso interno/esterno
indoor/outdoor using

Blik

Lampada da parete. Struttura in alluminio estruso con particolari in pressofusione di alluminio, verniciatura in polvere poliestere con trattamento di fosfatazione. Viti in acciaio inox. Guarnizioni in silicone. Diffusore in policarbonato colore anice e parabola in metallo verniciato bianco. Versione 20 e 30 LED con diffusore in vetro temperato sabbato internamente. Versioni 30 EL e 30 DM con diffusore in vetro trasparente temperato e parabola riflettente simmetrica in alluminio bugnato lucido. **Versione LED equipaggiata con led smd e alimentatore elettronico incorporato.**

Wall lamp. Structure made in extruded aluminium and die casting aluminium parts with polyester paint and phosphate treatment. Inox steel screws. Gasket made in silicone rubber. Diffuser made in polycarbonate colour anise and inside reflector made in white painted metal. Version 20 and 30 LED with diffuser made in tempered glass with sandblasted inside surface. Version 30 EL and 30 DM with diffuser made in transparent tempered glass and symmetric inside reflector made in rusticated bright aluminium. **LED version equipped with smd led and electronic driver included.**

Lampe à mur. Structure réalisée en extrusion d'aluminium avec parties en fonte d'aluminium. Vernis polyester traitement de phosphatation. Vis en acier inox. Joint en gomme de silicone. Diffuseur en polycarbonate couleur anis et réflecteur intérieur en métal verni blanc. Version 20 et 30 LED avec diffuseur en verre tempéré et sablé à l'intérieur. Version 30 EL et 30 DM avec diffuseur en verre transparent tempéré et réflecteur intérieur symétrique réalisé en aluminium brillant. **Version LED équipée avec led smd et ballast électronique incorporé.**

Lámpara de pared. Estructura de aluminio extrudido con detalles fundidos a presión de aluminio, pintura en polvo poliéster con tratamiento de fosfatación. Tornillos de acero inoxidable. Junta de protección de silicona. Difusor de policarbonato color anís y parábola reflectante de metal pintado blanco. Version 20 y 30 LED con difusor de vidrio templado arenado internamente. Version 30 EL y 30 DM con difusor de vidrio transparente templado y parábola reflectante simétrica de aluminio despulido brillante. **Version LED suministrada con led smd y alimentador electrónico incluido.**

Wandleuchte. Struktur aus Aluminium extrusion mit Einzelteilen aus Aludruckguss, Lackierung aus Polyester Pulver mit Phosphatierung. Schrauben aus rostfreiem Stahl. Silikondichtungen. Diffusor aus anisfarbenem Polycarbonat und Parabolspiegel aus weiß lackiertem Metall. Ausführung 20 und 30 LED mit Diffusor aus temperiertem Glas innen sandgestrahlt. Ausführung 30 EL und 30 DM mit Diffusor aus temperiertem Transparentglas und Symmetrischer reflektierender Parabolspiegel aus bossiert glänzenden Aluminium. **Ausführung LED zum led smd und integriert Versorgungsgerät elektronisch.**



Colore struttura Structure color

Blik 20

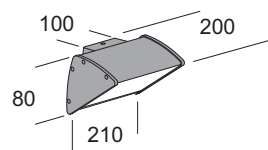

Articolo Item	Colore struttura Structure color				W _{max}	E27	LUMEN	IP65	LUMEN/W	A
	AT	BI	GR	RU						
E27 blik 20	62187	62181	62186	62188	1x46	E27	700	IP65	⊕	15 A
● Led blik 20 led-W	54247	54241	54246	54248	12,4	led	1700	IP65	⊕	137 B
● Led blik 20 led-N	54257	54251	54256	54258	12,4	led	1700	IP65	⊕	137 B
EL blik 20 EL	64097	64091	64096	64098	1x26	GX24q-3	1800	IP65	⊕	69 A

Blik 30

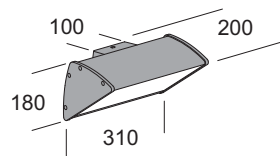

E27 blik 30	62007	62001	62006	62008	1x46	E27	700	IP65	⊕	15 A
● Led blik 30 led-W	54267	54261	54266	54268	23	led	3120	IP65	⊕	136 B
● blik 30S led-W	54277	54271	54276	54278	46	led	6240	IP65	⊕	136 B
● Led DM blik 30S DM led-W	54287	54281	54286	54288	46	led	6240	IP65	⊕	136 B
● Led blik 30 led-N	54297	54291	54296	54298	23	led	3120	IP65	⊕	136 B
● blik 30S led-N	54307	54301	54306	54308	46	led	6240	IP65	⊕	136 B
● Led DM blik 30S DM led-N	54317	54311	54316	54318	46	led	6240	IP65	⊕	136 B
EL blik 30/2x42 EL	63657	63651	63656	63658	2x42(a)	GX24q-4	6400	IP65	⊕	76 C
● DM blik 30/2x42 DM	64597	64591	64596	64598	2x42(a)	GX24q-4	6400	IP65	⊕	76 C

Colore struttura Structure color

● Nuova versione New version

AT RAL 7016 Antracite gofrato Embossed anthracite	BI RAL 9016 Bianco gofrato Embossed white	GR RAL 9006 Grigio gofrato Embossed grey	● RU Ruggine Rust
---	---	--	-----------------------------

● Led Equipaggiata con led 3000K - Equipped with led 3000K

● Led Equipaggiata con led 4000K - Equipped with led 4000K

● Led DM ● Led DM ● DM Dimmerabile PUSH/DALI
Dimmable PUSH/DALI (info page 10)

(a) Equipaggiato con alimentatore multipotenza per l'utilizzo di lampade da 26W-32W o 42W
Equipped with multi-power ballast to use bulbs of 26W-32W or 42W

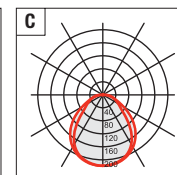
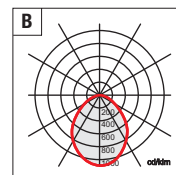
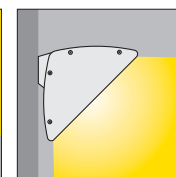
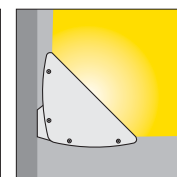
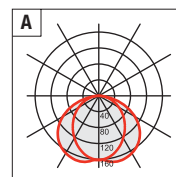

Blik 60

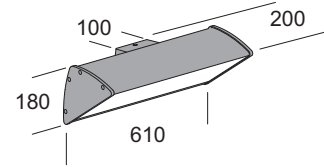

Colore struttura Structure color

Articolo Item	Colore struttura Structure color				W _{max}	LUMEN	IP	LUMEN/W	Icona
	AT	BI	GR	RU					
● Led blik 60 led-W	54327	54321	54326	54328	45,8	led 6260	IP65	⊕	137 C
● Led DM blik 60 DM led-W	54337	54331	54336	54338	45,8	led 6260	IP65	⊕	137 C
● Led EM blik 60 EM led-W	50087	50081	50086	50088	45,8	led 6260	IP65	⊕	137 C
● Led blik 60 led-N	54347	54341	54346	54348	45,8	led 6260	IP65	⊕	137 C
● Led DM blik 60 DM led-N	54357	54351	54356	54358	45,8	led 6260	IP65	⊕	137 C
● Led EM blik 60 EM led-N	50097	50091	50096	50098	45,8	led 6260	IP65	⊕	137 C
EL blik 60/2x24 EL	63087	63081	63086	63088	2x24	G5 4000	IP65	⊕	83 A
blik 60/2x36 EL	64267	64261	64266	64268	2x36	2G11 5800	IP65	⊕	81 B
blik 60/2x55 EL	63107	63101	63106	63108	2x55	2G11 9600	IP65	⊕	87 B
● DM blik 60/2x36 DM	64607	64601	64606	64608	2x36	2G11 5800	IP65	⊕	81 B
● blik 60/2x55 DM	64617	64611	64616	64618	2x55	2G11 9600	IP65	⊕	87 B
EM blik 60 EM/72	60177	60171	60176	60178	2x36	2G11 5800	IP65	⊕	81 B

Blik 120

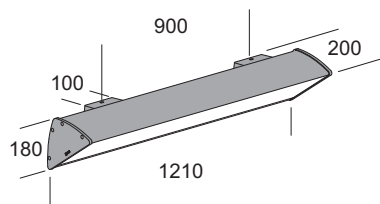

● Led blik 120 led-W	54367	54361	54366	54368	91,6	led 12520	IP65	⊕	137 C
● Led DM blik 120 DM led-W	54377	54371	54376	54378	91,6	led 12520	IP65	⊕	137 C
● Led blik 120 led-N	54387	54381	54386	54388	91,6	led 12520	IP65	⊕	137 C
● Led DM blik 120 DM led-N	54397	54391	54396	54398	91,6	led 12520	IP65	⊕	137 C
EL blik 120/2x54 EL	63147	63141	63146	63148	2x54	G5 10000	IP65	⊕	93 A
● DM blik 120/2x54 DM	64627	64621	64626	64628	2x54	G5 10000	IP65	⊕	93 A

Colore struttura Structure color

● Nuova versione New version

AT RAL 7016 Antracite gofrato Embossed anthracite	BI RAL 9016 Bianco gofrato Embossed white	GR RAL 9006 Grigio gofrato Embossed grey	RU Ruggine Rust
---	---	--	---------------------------

● Led Equipaggiata con led 3000K - Equipped with led 3000K

● Led Equipaggiata con led 4000K - Equipped with led 4000K

● Led DM Dimmerabile PUSH/DALI
Dimmable PUSH/DALI (info page 10)

● Led EM Emergenza (SA) 1h di serie - 3h a richiesta.
Emergency 1h standard - 3h on request

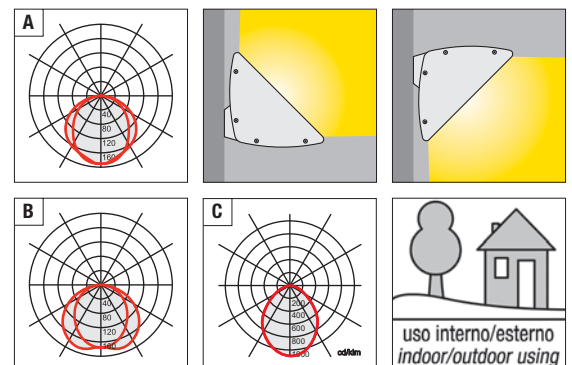

Star C

Lampada da parete orientabile. Struttura in alluminio estruso con particolari in pressofusione di alluminio, verniciatura in polvere poliestere con trattamento di fosfatazione. Viti in acciaio inox. Guarnizioni in silicone. Diffusore in policarbonato colore anice e parabola in metallo verniciato bianco. Versione 20 e 30 LED con diffusore in vetro temperato sabbiato internamente. Versioni 30 EL con diffusore in vetro trasparente temperato e parabola riflettente simmetrica in alluminio bugnato lucido. **Versione LED equipaggiata con led smd e alimentatore elettronico incorporato.**

Adjustable wall lamp. Structure made in extruded aluminium and die casting aluminium parts with polyester paint and phosphate treatment. Inox steel screws. Gasket made in silicone rubber. Diffuser made in polycarbonate colour anise and inside reflector made in white painted metal. Version 20 and 30 LED with diffuser made in tempered glass with sandblasted inside surface. Version 30 EL with diffuser made in transparent tempered glass and symmetric inside reflector made in rusticated bright aluminium. **LED version equipped with smd led and electronic driver included.**

Lampe à mur réglable. Structure réalisée en extrusion d'aluminium avec parties en fonte d'aluminium. Vernis polyester traitement de phosphatation. Vis en acier inox. Joint en gomme de silicone. Diffuseur en polycarbonate couleur anis et réflecteur intérieur en métal verni blanc. Version 20 et 30 LED avec diffuseur en verre tempéré et sablé à l'intérieur. Version 30 EL avec diffuseur en verre transparent tempéré et réflecteur intérieur symétrique réalisé en aluminium brillant. **Version LED équipée avec led smd et ballast électronique incorporé.**

Lámpara de pared giratoria. Estructura de aluminio extrudido con detalles fundidos a presión de aluminio, pintura en polvo poliéster con tratamiento de fosfatación. Tornillos de acero inoxidable. Junta de protección de silicona. Difusor de policarbonato color anís y parábola reflectante de metal pintado blanco. Version 20 y 30 LED con difusor de vidrio templado arenado internamente. Version 30 EL con difusor de vidrio transparente templado y parábola reflectante simétrica de aluminio despulido brillante. **Version LED suministrada con led smd y alimentador electrónico incluido.**

Schwenkbare Wandleuchte. Struktur aus Aluminium extrusion mit Einzelteilen aus Aludruckguss, Lackierung aus Polyester Pulver mit Phosphatierung. Schrauben aus rostfreiem Stahl. Silikondichtungen. Diffusor aus anisfarbenem Polycarbonat und Parabolspiegel aus weiß lackiertem Metall. Ausführung 20 und 30 LED mit Diffusor aus temperiertem Glas innen sandgestrahlt. Ausführung 30 EL mit Diffusor aus temperiertem Transparentglas und Symmetrischer reflektierender Parabolspiegel aus bossiert glänzenden Aluminium. **Ausführung LED zum led smd und integriert Versorgungsgerät elektronisch.**



Colore struttura Structure color

Star C20

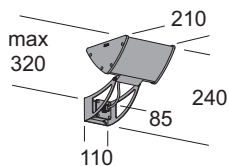

Articolo Item	Colore struttura Structure color				W _{max}	E27	LUMEN	IP65	⊕	LUMEN/W	☀️
	AT	BI	GR	RU							
E27 star C20	62217	62211	62216	62218	1x46	E27	700	IP65	⊕	15	A
● Led star C20 led-W	54407	54401	54406	54408	12,4	led	1700	IP65	⊕	137	B
● Led star C20 led-N	54417	54411	54416	54418	12,4	led	1700	IP65	⊕	137	B
EL star C20 EL	64357	64351	64356	64358	1x26	GX24q-3	1800	IP65	⊕	69	A

Star C30

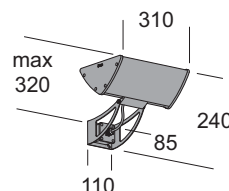

E27 star C30	62127	62121	62126	62128	1x46	E27	700	IP65	⊕	15	A
● Led star C30 led-W	54427	54421	54426	54428	23	led	3120	IP65	⊕	136	B
● star C30S led-W	54437	54431	54436	54438	46	led	6240	IP65	⊕	136	B
● Led star C30 led -N	54447	54441	54446	54448	23	led	3120	IP65	⊕	136	B
● star C30S led-N	54457	54451	54456	54458	46	led	6240	IP65	⊕	136	B
EL star C30/2x42 EL	63707	63701	63706	63708	2x42(a)	GX24q-4	6400	IP65	⊕	76	C

Colore struttura Structure color

● Nuova versione New version

AT RAL 7016 Antracite gofrato Embossed anthracite	BI RAL 9016 Bianco gofrato Embossed white	GR RAL 9006 Grigio gofrato Embossed grey	RU Ruggine Rust
---	---	--	---------------------------

● Led Equipaggiata con led 3000K - Equipped with led 3000K

● Led Equipaggiata con led 4000K - Equipped with led 4000K

(a) Equipaggiato con alimentatore multipotenza per l'utilizzo di lampade da 26W-32W o 42W
Equipped with multi-power ballast to use bulbs of 26W-32W or 42W

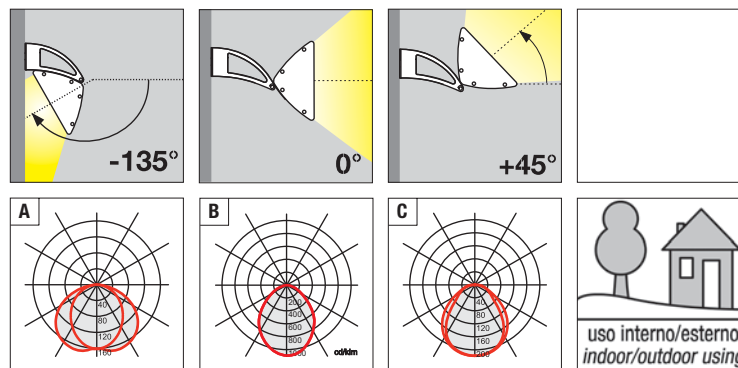

Star C60

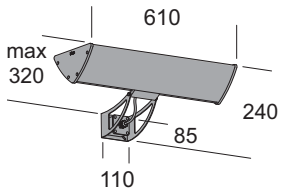

Colore struttura Structure color

Articolo Item

AT BI GR RU
Codice Code

W_{max}



LUMEN



LUMEN/W



● Led	star C60 led-W	54467	54461	54466	54468	45,8	led	6260	IP65	⊕	137	C
● Led EM	star C60 EM led-W	50107	50101	50106	50108	45,8	led	6260	IP65	⊕	137	C
● Led	star C60 led-N	54477	54471	54476	54478	45,8	led	6260	IP65	⊕	137	C
● Led EM	star C60 EM led-N	50117	50111	50116	50118	45,8	led	6260	IP65	⊕	137	C
EL	star C60/2x24 EL	63767	63761	63766	63768	2x24	G5	4000	IP65	⊕	83	A
	star C60/2x36 EL	64387	64381	64386	64388	2x36	2G11	5800	IP65	⊕	81	B
	star C60/2x55 EL	63777	63771	63776	63778	2x55	2G11	9600	IP65	⊕	87	B
EM	star C60 EM/72	60197	60191	60196	60198	2x36	2G11	5800	IP65	⊕	81	B

Star C120

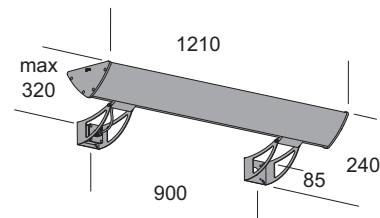

● Led	star C120 led-W	54487	54481	54486	54488	91,6	led	12520	IP65	⊕	137	C
● Led	star C120 led-N	54497	54491	54496	54498	91,6	led	12520	IP65	⊕	137	C
EL	star C120/2x54 EL	64037	64031	64036	64038	2x54	G5	10000	IP65	⊕	93	A

Colore struttura Structure color

● Nuova versione New version

AT RAL 7016
Antracite gofrato Embossed anthracite

BI RAL 9016
Bianco gofrato Embossed white

GR RAL 9006
Grigio gofrato Embossed grey

● RU
Ruggine Rust

● Led Equipaggiata con led 3000K - Equipped with led 3000K

● Led Equipaggiata con led 4000K - Equipped with led 4000K

● Led EM ● Led EM EM Emergenza (SA) 1h di serie – 3h a richiesta.
Emergency 1h standard – 3h on request

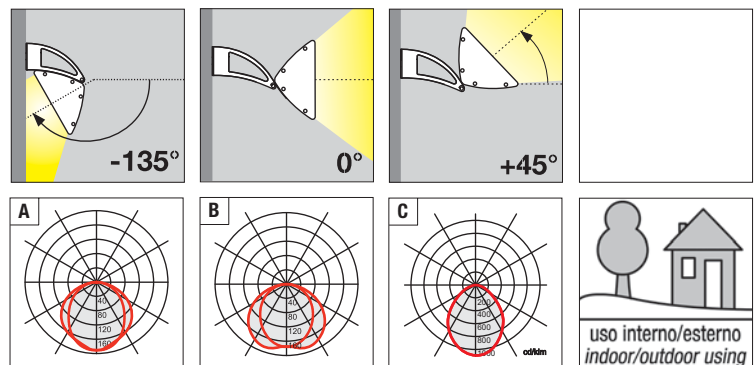



Star L

Lampada da parete orientabile. Struttura in alluminio estruso con particolari in pressofusione di alluminio, verniciatura in polvere poliestere con trattamento di fosfatazione. Viti in acciaio inox. Guarnizioni in silicone. Diffusore in policarbonato colore anice e parabola in metallo verniciato bianco. Versione 30LED con diffusore in vetro temperato sabbiato internamente. Versioni 30EL con diffusore in vetro trasparente temperato e parabola riflettente simmetrica in alluminio bugnato lucido. **Versione LED equipaggiata con led smd e alimentatore elettronico incorporato.**

Adjustable wall lamp. Structure made in extruded aluminium and die casting aluminium parts with polyester paint and phosphate treatment. Inox steel screws. Gasket made in silicone rubber. Diffuser made in polycarbonate colour anise and inside reflector made in white painted metal. Version 30LED with diffuser made in tempered glass with sandblasted inside surface. Version 30EL with diffuser made in transparent tempered glass and symmetric inside reflector made in rusticated bright aluminium. **LED version equipped with smd led and electronic driver included.**

Lampe à mur réglable. Structure réalisée en extrusion d'aluminium avec parties en fonte d'aluminium. Vernis polyester traitement de phosphatation. Vis en acier inox. Joint en gomme de silicone. Diffuseur en polycarbonate couleur anis et réflecteur intérieur en métal verni blanc. Version 30LED avec diffuseur en verre tempéré et sablé à l'intérieur. Version 30EL avec diffuseur en verre transparent tempéré et réflecteur intérieur symétrique réalisé en aluminium brillant. **Version LED équipée avec led smd et ballast électronique incorporé.**

Lámpara de pared giratoria. Estructura de aluminio extrudido con detalles fundidos a presión de aluminio, pintura en polvo poliéster con tratamiento de fosfatación. Tornillos de acero inoxidable. Junta de protección de silicona. Difusor de policarbonato color anís y parábola reflectante de metal pintado blanco. Version 30LED con difusor de vidrio templado arenado internamente. Version 30EL con difusor de vidrio transparente templado y parábola reflectante simétrica de aluminio despulido brillante. **Version LED suministrada con led smd y alimentador electrónico incluido.**

Schwenkbare Wandleuchte. Struktur aus Aluminium extrusion mit Einzelteilen aus Aludruckguss, Lackierung aus Polyester Pulver mit Phosphatierung. Schrauben aus rostfreiem Stahl. Silikondichtungen. Diffusor aus anisfarbenem Polycarbonat und Parabolspiegel aus weiß lackiertem Metall. Ausführung 30LED mit Diffusor aus temperiertem Glas innen sandgestrahlt. Ausführung 30EL mit Diffusor aus temperiertem Transparentglas und Symmetrischer reflektierender Parabolspiegel aus bossiert glänzenden Aluminium. **Ausführung LED zum led smd und integriert Versorgungsgerät elektronisch.**

Star L30

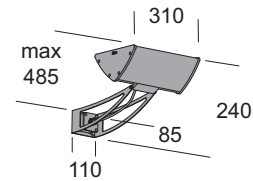

Articolo <i>Item</i>	Colore struttura <i>Structure color</i>				W _{max}	E27	LUMEN	IP65	LUMEN/W	A
	AT	BI	GR	RU						
E27 star L30	62137	62131	62136	62138	1x46	E27	700	IP65	⊕ 15	A
● Led star L30 led-W	54507	54501	54506	54508	23	led	3120	IP65	⊕ 136	D
● star L30S led-W	54517	54511	54516	54518	46	led	6240	IP65	⊕ 136	D
● Led star L30 led -N	54527	54521	54526	54528	23	led	3120	IP65	⊕ 136	D
● star L30S led-N	54537	54531	54536	54538	46	led	6240	IP65	⊕ 136	D
EL star L30/2x42 EL	63817	63811	63816	63818	2x42(a)	GX24q-4	6400	IP65	⊕ 76	C

Star L60

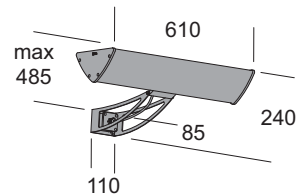

● Led star L60 led-W	54547	54541	54546	54548	45,8	led	6260	IP65	⊕ 137	D
● Led EM star L60 EM led-W	50127	50121	50126	50128	45,8	led	6260	IP65	⊕ 137	D
● Led star L60 led-N	54557	54551	54556	54558	45,8	led	6260	IP65	⊕ 137	D
● Led EM star L60 EM led-N	50137	50131	50136	50138	45,8	led	6260	IP65	⊕ 137	D
EL star L60/2x24 EL	63877	63871	63876	63878	2x24	G5	4000	IP65	⊕ 83	B
star L60/2x36 EL	64417	64411	64416	64418	2x36	2G11	5800	IP65	⊕ 81	B
star L60/2x55 EL	63887	63881	63886	63888	2x55	2G11	9600	IP65	⊕ 87	B
EM star L60 EM/72	60207	60201	60206	60208	2x36	2G11	5800	IP65	⊕ 81	B

Star L120

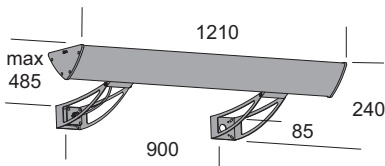

● Led star L120 led-W	54567	54561	54566	54568	91,6	led	12520	IP65	⊕ 137	D
● Led star L120 led-N	54577	54571	54576	54578	91,6	led	12520	IP65	⊕ 137	D
EL star L120/2x54 EL	64077	64071	64076	64078	2x54	G5	10000	IP65	⊕ 93	B

Colore struttura *Structure color*

AT RAL 7016
Antracite goffrato *Embossed anthracite*

BI RAL 9016
Bianco goffrato *Embossed white*

GR RAL 9006
Grigio goffrato *Embossed grey*

● **RU**
Ruggine *Rust*

Led Equipaggiata con led 3000K - *Equipped with led 3000K*

Led Equipaggiata con led 4000K - *Equipped with led 4000K*

Led EM **Led EM** **EM** Emergenza (SA) 1h di serie – 3h a richiesta.
Emergency 1h standard – 3h on request

(a) Equipaggiato con alimentatore multipotenza per l'utilizzo di lampade da 26W-32W o 42W
Equipped with multi-power ballast to use bulbs of 26W-32W or 42W

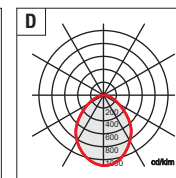
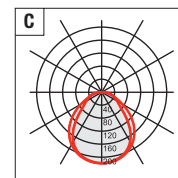
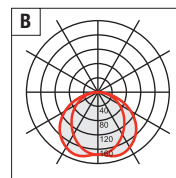
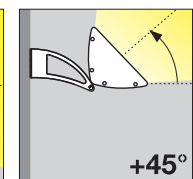
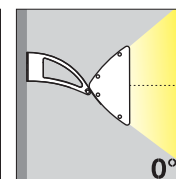
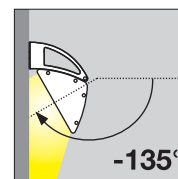
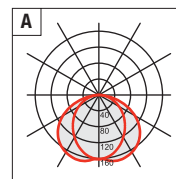



Step Led

Lampada da parete. Diffusore in policarbonato opale. Struttura in pressofusione di alluminio, verniciatura in polvere poliestere con trattamento di fosfatazione. Viti in acciaio inox. Guarnizioni in gomma ai polimeri. Predisposta per il collegamento di un cavo di ingresso (alimentazione della rete) e un cavo di uscita (alimentazione degli apparecchi a "cascata" in parallelo). **Equipaggiata con led smd e alimentatore elettronico incorporato.**

Wall lamp. Diffuser made in opal polycarbonate. Structure made in die casting aluminium with polyester paint and phosphate treatment. Inox steel screws. Gaskets made in rubber. Ready to connect an input cable (mains supply) and an output cable (power to devices in "cascade" in parallel). **Equipped with smd led and electronic driver included.**

Lampe à mur. Diffuseur en polycarbonate opale. Structure réalisée en fonte d'aluminium. Vernis polyester traitement de phosphatation. Vis en acier inox. Joint en gomme. Prêt pour la connexion d'un câble d'entrée (alimentation secteur) et un câbles de sortie (puissance aux dispositifs de la "cascade" en parallèle). **Equipée avec led smd et ballast électronique incorporé.**

Lámpara de pared. Difusor de policarbonato opal. Estructura en fundición a presión de aluminio, pintura en polvo poliéster con tratamiento de fosfatación. Tornillos de acero inoxidable. Junta de protección de goma. Listo para la conexión de un cable de entrada (red eléctrica) y un cable de salida (energía a los dispositivos en "cascada" en paralelo). **Suministrada con led smd y alimentador electrónico incluido.**

Wandleuchte. Diffusor aus opalem Polycarbonat. Struktur aus Aludruckguss, Lackierung aus Polyester Pulver mit Phosphatierung. Schrauben aus Edelstahl. Dichtungen aus Polymergummi. Ausgestattet zum Anschließen einer Kabelnetz (Eingangsspannung) und einer Output-Kabel (Stromversorgung von Geräten in "Kaskade" parallel). **Ausgestattet mit LED smd. Eingebautem elektronischem Versorgungsgerät.**





Step 1 Led	Articolo <i>Item</i>	Colore struttura <i>Structure color</i>				W _{max}		LUMEN		LUMEN/W	
		AT	BI	GR	RU						

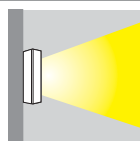
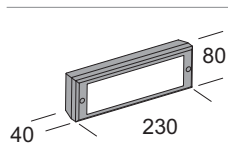

• Led	step 1 led-W	54587	54581	54586	54588	6,3	led	750	IP65	⊕	119	A
• Led	step 1 led-N	54597	54591	54596	54598	6,3	led	750	IP65	⊕	119	A

Step 2 Led

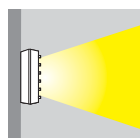
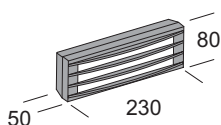

• Led	step 2 led-W	54607	54601	54606	54608	6,3	led	750	IP65	⊕	119	B
• Led	step 2 led-N	54617	54611	54616	54618	6,3	led	750	IP65	⊕	119	B

Step 3 Led

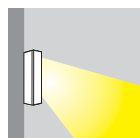
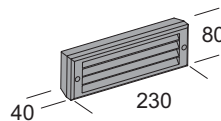

• Led	step 3 led-W	54627	54621	54626	54628	6,3	led	750	IP65	⊕	119	C
• Led	step 3 led-N	54637	54631	54636	54638	6,3	led	750	IP65	⊕	119	C

Colore struttura *Structure color*

AT RAL 7016 Antracite gofrato <i>Embossed anthracite</i>	BI RAL 9016 Bianco gofrato <i>Embossed white</i>	GR RAL 9006 Grigio gofrato <i>Embossed grey</i>	• RU Ruggine <i>Rust</i>
--	--	---	------------------------------------

- Led Equipaggiata con led 3000K - *Equipped with led 3000K*
- Led Equipaggiata con led 4000K - *Equipped with led 4000K*

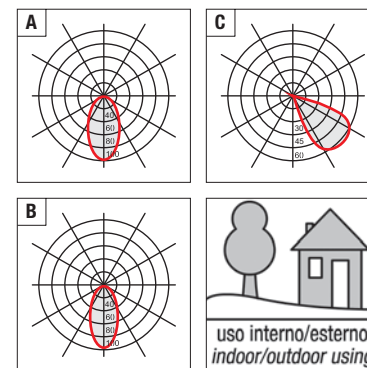

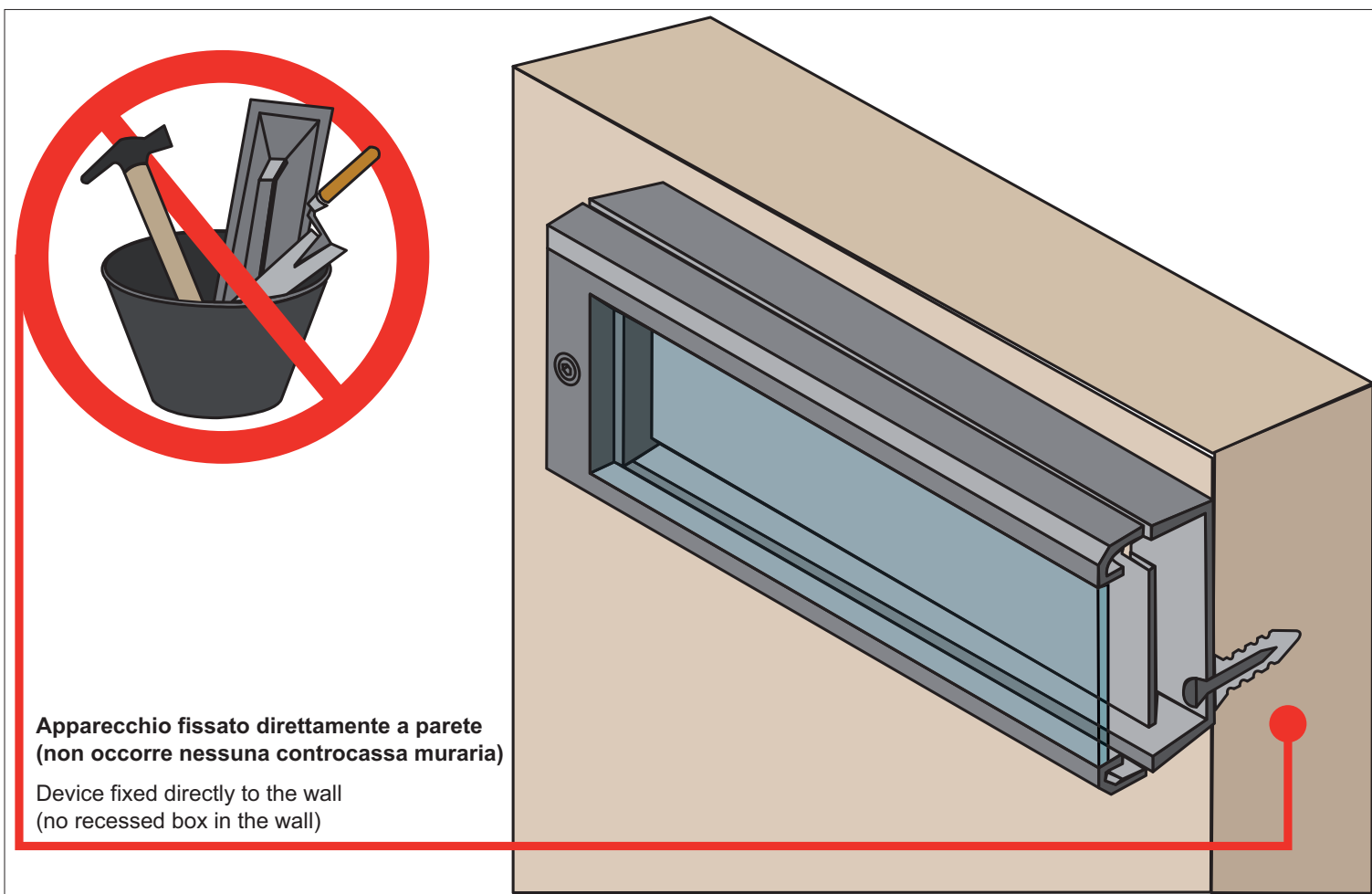

Apparecchio fissato direttamente a parete senza cassaforma nel muro.

Device fixed directly to the wall without recessed box in the cement.

Dispositif installé directement au mur sans boîtier d'encastrement.

Dispositivo instalado directamente a la pared sin caja de empotrar.

Wandleuchte installiert direkt auf einer Wand, ohne Wandschalung.

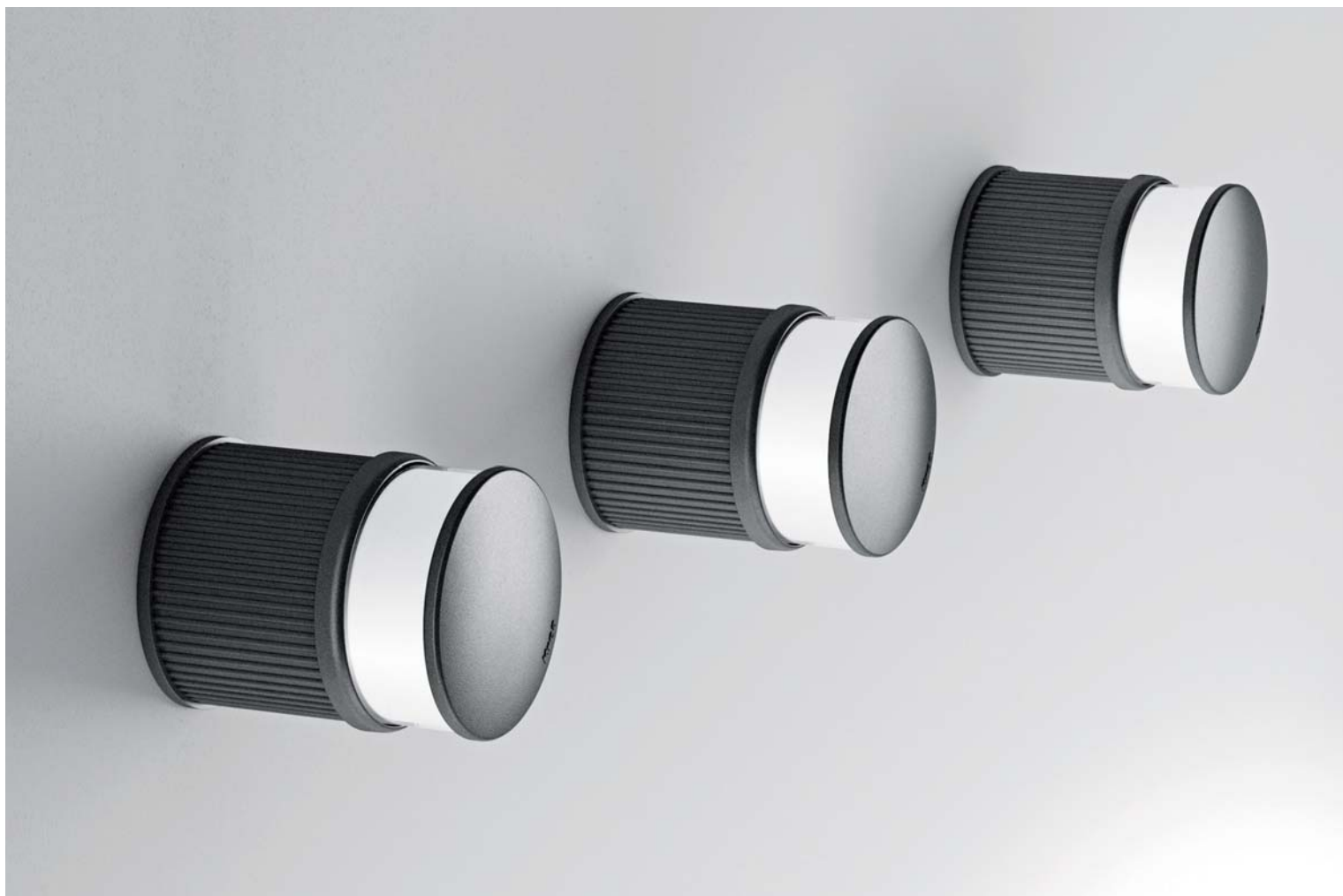

Nano APS

Lampada da parete. Diffusore in policarbonato trasparente, con pellicola di policarbonato opale inserita internamente. Struttura in alluminio estruso con particolari in policarbonato, verniciatura in polvere poliestere con trattamento di fosfatazione. Viti in acciaio inox. Guarnizioni in silicone. Riflettore interno in alluminio per luce indiretta. Predisposta per il collegamento di un cavo di ingresso (alimentazione della rete) e un cavo di uscita (alimentazione degli apparecchi a "cascata" in parallelo). **Equipaggiata con led smd e alimentatore elettronico incorporato.**

Wall lamp. Diffuser made in transparent polycarbonate with inside opal polycarbonate film. Structure made in extruded aluminium and polycarbonate parts with polyester paint and phosphate treatment. Inox steel screws. Gasket made in silicon rubber. Aluminium inside reflector for indirect light. Ready to connect an input cable (mains supply) and an output cable (power to devices in "cascade" in parallel). **Equipped with smd led and electronic driver included.**

Lampe à mur. Diffuseur en polycarbonate transparente avec un film de polycarbonate opale à l'intérieur. Structure réalisée en extrusion d'aluminium avec parties en polycarbonate. Vernis polyester traitement de phosphatation. Vis en acier inox. Joint en gomme de silicone. Réflecteur intérieur en aluminium pour éclairage indirecte. Prêt pour la connexion d'un câble d'entrée (alimentation secteur) et un câbles de sortie (puissance aux dispositifs de la "cascade" en parallèle). **Equipée avec led smd et ballast électronique incorporé.**

Lámpara de pared. Difusor de policarbonato transparente, con una película interna de policarbonato opale. Estructura de aluminio extrudido con detalles de policarbonato, pintura en polvo poliéster con tratamiento de fosfatación. Tornillos de acero inoxidable. Junta de protección de silicona. Reflector interno en aluminio para iluminación indirecta. Listo para la conexión de un cable de entrada (red eléctrica) y un cable de salida (energía a los dispositivos en "cascada" en paralelo). **Suministrada con led smd y alimentador electrónico incluido.**

Wandleuchte. Diffusor aus transparentem Polycarbonat mit eine innen Opal Polycarbonatfilm. Struktur aus Aluminium extrusion mit Einzelteilen aus Polycarbonat, Lackierung aus Polyester Pulver mit Phosphatierung. Schrauben aus Edelstahl. Silikondichtungen. Reflektor aus Aluminium für indirektem licht. Ausgestattet zum Anschließen einer Kabelnetz (Eingangsspannung) und einer Output-Kabel (Stromversorgung von Geräten in "Kaskade" parallel). **Ausgestattet mit LED smd. Eingebautem elektronischem Versorgungsgerät.**

Nano APS

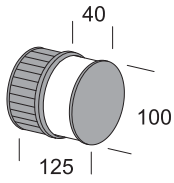

Colore struttura Structure color

Articolo Item

AT BI GR RU
Codice Code

W_{max}



LUMEN



LUMEN/W



● Led	nano APS led-W	55977	55971	55976	55978	5,6	led	640	IP65	⊕	114	A
● Led	nano APS led-N	55987	55981	55986	55988	5,6	led	640	IP65	⊕	114	A



Colore struttura Structure color

AT RAL 7016
Antracite gofrato Embossed anthracite

BI RAL 9016
Bianco gofrato Embossed white

GR RAL 9006
Grigio gofrato Embossed grey

● **RU**
Ruggine Rust

● Led Equipaggiata con led 3000K - Equipped with led 3000K

● Led Equipaggiata con led 4000K - Equipped with led 4000K

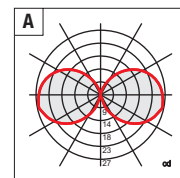
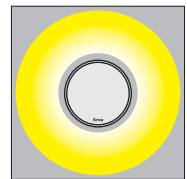
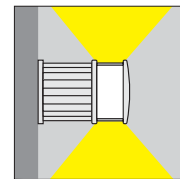



Ark led

Lampada da parete. Struttura in alluminio estruso con particolari in pressofusione di alluminio, verniciatura in polvere poliesteri con trattamento di fosfatazione. Diffusore in policarbonato. Viti in acciaio inox. Guarnizioni in silicone. **Versione Ark10 equipaggiata con led smd e alimentatore elettronico incorporato. Versione Ark20 equipaggiata LED COB e alimentatore elettronico incorporato.**

Wall lamp. Structure made in extruded aluminium and die casting aluminium parts with polyester paint and phosphate treatment. Diffuser made in polycarbonate. Inox steel screws. Gasket made in silicone rubber. **Version Ark10 equipped with smd led and electronic driver included. Version Ark20 equipped with COB LED and electronic gear included.**

Lampe à mur. Structure réalisée en extrusion d'aluminium avec parties en fonte d'aluminium. Vernis polyester traitement de phosphatation. Diffuseur en polycarbonate. Vis en acier inox. Joint en gomme de silicone. **Version Ark10 équipée avec led smd et ballast électronique incorporé. Version Ark20 équipée avec LED COB et ballast électronique incorporé.**

Lámpara de pared. Estructura de aluminio extrudido con detalles fundidos a presión de aluminio, pintura en polvo poliéster con tratamiento de fosfatación. Difusor de policarbonato. Tornillos de acero inoxidable. Junta de protección de silicona. **Version Ark10 suministrada con led smd y alimentador electrónico incluido. Version Ark20 suministrada con LED COB y alimentador electrónico incorporado.**

Wandleuchte. Struktur aus Aluminium extrusion mit Einzelteilen aus Aludruckguss, Lackierung aus Polyester Pulver mit Phosphatierung. Diffusor aus Polycarbonat. Schrauben aus rostfreiem Stahl. Silikondichtungen. **Ausführung Ark10 mit led smd und integriert Versorgungsgerät elektronisch. Ausführung Ark20 mit LED COB und integriert Versorgungsgerät elektronisch.**



Ark 10 Led	Articolo Item	Colore struttura Structure color				W _{max}		LUMEN		LUMEN/W		
		AT	BI	GR	RU							Codice Code
	• Led ark 10 led-W	55447	55441	55446	55448	8	led	950	IP65	⊕	119	A
	• Led ark 10 led-N	55457	55451	55456	55458	8	led	950	IP65	⊕	119	A
	• Led ark 10/2 led-W	55467	55461	55466	55468	16	led	1900	IP65	⊕	119	B
	• Led ark 10/2 led-N	55477	55471	55476	55478	16	led	1900	IP65	⊕	119	B
	• Led ark 10 MIX led-W	55487	55481	55486	55488	14	led	1450	IP65	⊕	104	C
	• Led ark 10 MIX led-N	55497	55491	55496	55498	14	led	1450	IP65	⊕	104	C



Consigliato per installazioni residenziali.
Recommended for residential installations.
Recommandé pour les installations résidentielles.
Recomendado para instalaciones residenciales.
Empfohlen für Wohnanlagen.

Colore struttura Structure color

• Nuova versione New version

AT RAL 7016 Antracite gofrato Embossed anthracite	BI RAL 9016 Bianco gofrato Embossed white	GR RAL 9006 Grigio gofrato Embossed grey	• RU Ruggine Rust
---	---	--	-----------------------------

- Led** Equipaggiata con led 3000K - Equipped with led 3000K
- Led** Equipaggiata con led 4000K - Equipped with led 4000K

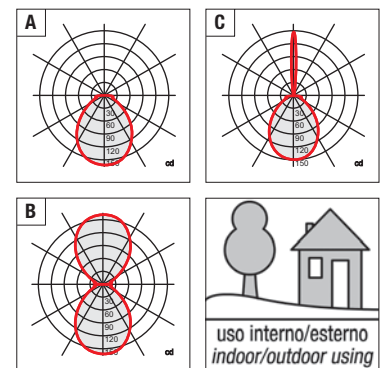

Ark 20 Led

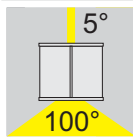
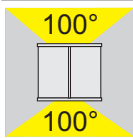
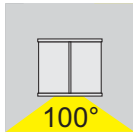
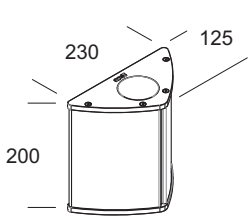

Colore struttura Structure color

Articolo Item

AT BI GR RU
Codice Code

W_{max}



LUMEN



LUMEN/W



● Led	ark 20 led-W	55507	55501	55506	55508	16,5	led	2000	IP65	⊕	121	A
● Led	ark 20 led-N	55517	55511	55516	55518	16,5	led	2000	IP65	⊕	121	A
● Led	ark 20/2 led-W	55527	55521	55526	55528	33	led	4000	IP65	⊕	121	B
● Led	ark 20/2 led-N	55537	55531	55536	55538	33	led	4000	IP65	⊕	121	B
● Led	ark 20 MIX led-W	55547	55541	55546	55548	22,5	led	2500	IP65	⊕	111	C
● Led	ark 20 MIX led-N	55557	55551	55556	55558	22,5	led	2500	IP65	⊕	111	C



Consigliato per illuminazione architettonale.
Recommended for architectural lighting.
Recommandé pour l'éclairage architectural.
Recomendado para la iluminación arquitectónica.
Empfohlen für Architekturbeleuchtung.

Colore struttura Structure color

● Nuova versione New version

AT RAL 7016
Antracite gofrato Embossed anthracite

BI RAL 9016
Bianco gofrato Embossed white

GR RAL 9006
Grigio gofrato Embossed grey

● RU
Ruggine Rust

● Led Equipaggiata con led 3000K - Equipped with led 3000K

● Led Equipaggiata con led 4000K - Equipped with led 4000K

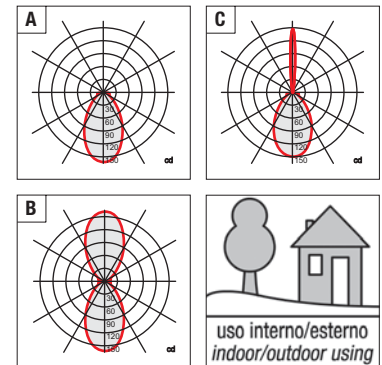



Kit

Lampada da parete. Diffusore in policarbonato colore anice. Parabola in metallo verniciato bianco. Struttura in alluminio estruso con particolari in pressofusione di alluminio, verniciatura in polvere poliesteri con trattamento di fosfatazione. Viti in acciaio inox. Guarnizioni in silicone. **Versione LED equipaggiata con led smd e alimentatore elettronico incorporato.**

Wall lamp. Diffuser made in polycarbonate colour anise. Inside reflector made in white painted metal. Structure made in extruded aluminium and die casting aluminium parts with polyester paint and phosphate treatment. Inox steel screws. Gaskets made in silicone rubber. **LED version equipped with smd led and electronic driver included.**

Lampe à mur. Diffuseur en polycarbonate couleur anis. Réflecteur intérieur en métal verni blanc. Structure réalisée en extrusion d'aluminium avec parties en fonte d'aluminium. Vernis polyester traitement de phosphatation. Vis en acier inox. Joint en gomme de silicone. **Version LED équipée avec led smd et ballast électronique incorporé.**

Lámpara de pared. Difusor de policarbonato color anís. Parábola reflectante de metal pintado blanco. Estructura de aluminio extrudido con detalles fundidos a presión de aluminio, pintura en polvo poliéster con tratamiento de fosfatación. Tornillos de acero inoxidable. Junta de protección de silicona. **Version LED suministrada con led smd y alimentador electrónico incluido.**

Wandleuchte. Diffusor aus anisfarbenem Polycarbonat. Parabolspiegel aus weiß lackiertem Metall. Struktur aus Aluminium extrusion mit Einzelteilen aus Aludruckguss, Lackierung aus Polyester Pulver mit Phosphatierung. Schrauben aus rostfreiem Stahl. Silikondichtungen. **Ausführung LED zum led smd und integriert Versorgungsgerät elektronisch.**



450 **indice**
index

384 **lampioni ed incassi**
bollards & recessed lights

344 **lampade**
lamps

258 **sospensioni**
suspensions

248 **testaletto**
bed head units

150 **plafoniere interni/esterni**
ceiling bowls indoor/outdoor

14 **applique interni/esterni**
wall lights indoor/outdoor

Kit 1	Articolo <i>Item</i>	Colore struttura <i>Structure color</i>				W _{max}		LUMEN		LUMEN/W		
		AT	BI	GR	RU							
		Codice <i>Code</i>										
	kit 1	62167	62161	62166	62168	1x57	E27	915	IP65	⊕	16	A
	kit 1 led-W	55567	55561	55566	55568	12,6	led	950	IP65	⊕	75	A
	kit 1 led-N	55577	55571	55576	55578	12,6	led	950	IP65	⊕	75	A
	kit 1 EL	63977	63971	63976	63978	1x26	GX24q-3	1800	IP65	⊕	69	A

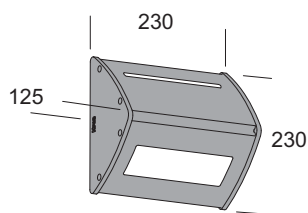

Kit 2	Articolo <i>Item</i>	Colore struttura <i>Structure color</i>				W _{max}		LUMEN		LUMEN/W		
		AT	BI	GR	RU							
		Codice <i>Code</i>										
	kit 2	62177	62171	62176	62178	1x57	E27	915	IP65	⊕	16	B
	kit 2 led-W	55587	55581	55586	55588	12,6	led	1500	IP65	⊕	119	B
	kit 2 led-N	55597	55591	55596	55598	12,6	led	1500	IP65	⊕	119	B
	kit 2 EL	63997	63991	63996	63998	1x26	GX24q-3	1800	IP65	⊕	69	B

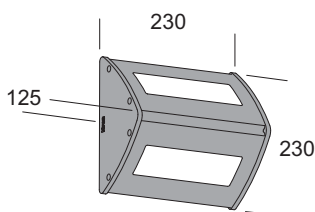

Colore struttura *Structure color*

Nuova versione *New version*

RAL 7016 Antracite gofrato <i>Embossed anthracite</i>	RAL 9016 Bianco gofrato <i>Embossed white</i>	RAL 9006 Grigio gofrato <i>Embossed grey</i>	Ruggine Rust
---	---	--	---------------------

- Equipaggiata con led 3000K - *Equipped with led 3000K*
- Equipaggiata con led 4000K - *Equipped with led 4000K*

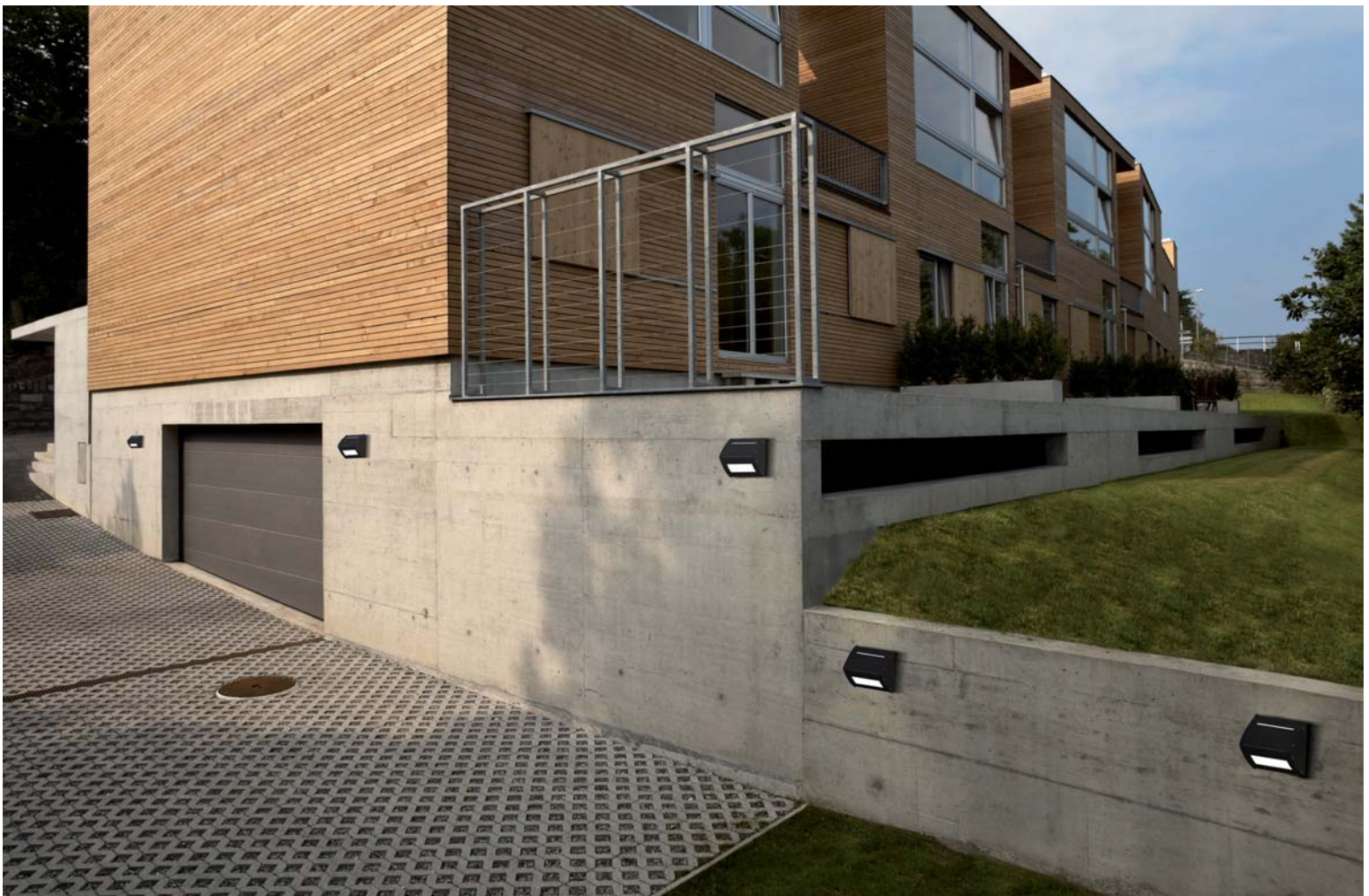

14 applique interni/esterni
wall lights indoor/outdoor

150 plafoniere interni/esterni
ceiling bowls indoor/outdoor

248 testaletto
bed head units

258 sospensioni
suspensions

344 lampade
lamps

384 lampioni ed incassi
bollards & recessed lights

450 indice
index



Cover

Lampada da parete. La base trasparente o colorata permette di creare, sulla parete, un alone colorato mantenendo il flusso di luce centrale bianco. Diffusore in policarbonato colore anice, prismatico internamente. Base in policarbonato autoestinguente. Visiera in tecnopolimero colorato grigio gofrato ral 9006, antracite gofrato ral 7016 o colore ruggine. **Versione LED equipaggiata con led smd e alimentatore elettronico incorporato.**

Wall lamp. The transparent or coloured base permit to create, on the wall, a coloured ring leaving the central light in white. Diffuser made in polycarbonate colour anise prismatic inside. Base made in polycarbonate auto-extinguishing. Visor made in techno-polymer embossed grey ral 9006, embossed anthracite ral 7016 painted or rust color. **LED version equipped with smd led and electronic driver included.**

Lampe à mur. La base transparente ou colorée permet de créer, sur le mur, un halo coloré conservant la lumière centrale blanche. Diffuseur en polycarbonate couleur anis, prismatique à l'intérieur. Base réalisée en polycarbonate auto extinguable. Visière en techno-polymère verni gris gaufré ral 9006, anthracite gaufré ral 7016 ou couleur rouille. **Versión LED équipée avec led smd et ballast électronique incorporé.**

Lámpara de pared. La base transparente o de colores permite crear, en la pared, un halo de colores manteniendo el flujo de luz central blanco. Difusor de policarbonato de color anís, prismatico internamente. Base de policarbonato de autoextinción. Visera de tecnopolímero de colores gris rugoso ral 9006, antracita rogoso ral 7016 o color herrumbre. **Versión LED suministrada con led smd y alimentador electrónico incluido.**

Wandleuchte. Die transparente oder farbige Basis ermöglicht es, an der Wand einen farbigen Lichthof zu erzeugen, während der zentrale Lichtfluss weiß bleibt. Diffusor aus anisfarbenem Polycarbonat, innen prismatisch. Basis aus selbstlöschendem Polycarbonat. Visier aus Technopolymer, Farbe grau gaufriert Ral 9006, anthrazit gaufriert Ral 7016 oder Rostfarbe. **Ausführung LED zum led smd und integriert Versorgungsgerät elektronisch.**

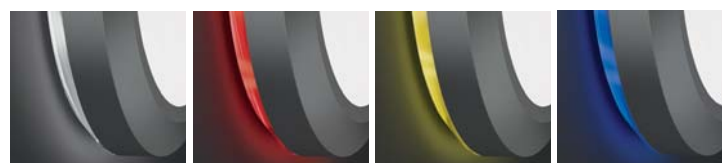

Cover grigio

GR RAL 9006
Grigio gofrato *Embossed grey*

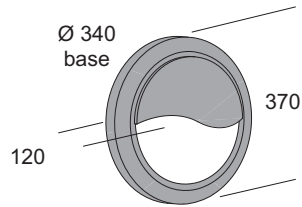

Cover antracite

AT RAL 7016
Antracite gofrato *Embossed anthracite*

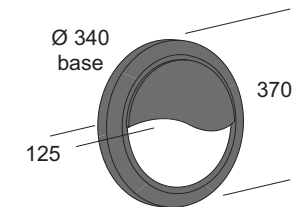

Cover ruggine

RU
Ruggine *Rust*

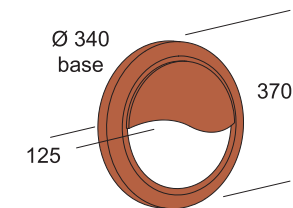

Colore base *Frame color*

BL	GI	RO	TR
Blu <i>Blue</i>	Giallo <i>Yellow</i>	Rosso <i>Red</i>	Trasparente <i>Transparent</i>

W_{max}		LUMEN		LUMEN/W	
------------------------	--	-------	--	---------	--

Articolo <i>Item</i>	BL	GI	RO	TR	W _{max}	LED	LUMEN	IP65	LUMEN/W	Beam spread
E27 cover GR	62105	62102	62103	62101	1x77	E27	1320	IP65	17	A
Led cover led-W GR	54665	54662	54663	54661	15,3	led	2070	IP65	135	B
Led EM cover EM led-W GR	50165	50162	50163	50161	15,3	led	2070	IP65	135	B
Led cover led-N GR	54675	54672	54673	54671	15,3	led	2070	IP65	135	B
Led EM cover EM led-N GR	50175	50172	50173	50171	15,3	led	2070	IP65	135	B
EL cover EL GR	63425	63422	63423	63421	1x26	G24q-3	1800	IP65	69	A
EM cover EM GR	60055	60052	60053	60051	1x26	G24q-3	1800	IP65	69	A
E27 cover AT	62095	62092	62093	62091	1x77	E27	1320	IP65	17	A
Led cover led-W AT	54645	54642	54643	54641	15,3	led	2070	IP65	135	B
Led EM cover EM led-W AT	50145	50142	50143	50141	15,3	led	2070	IP65	135	B
Led cover led-N AT	54655	54652	54653	54651	15,3	led	2070	IP65	135	B
Led EM cover EM led-N AT	50155	50152	50153	50151	15,3	led	2070	IP65	135	B
EL cover EL AT	63415	63412	63413	63411	1x26	G24q-3	1800	IP65	69	A
EM cover EM AT	60045	60042	60043	60041	1x26	G24q-3	1800	IP65	69	A
E27 cover RU	62231				1x77	E27	1320	IP65	17	A
Led cover led-W RU	54681				15,3	led	2070	IP65	135	B
Led EM cover EM led-W RU	50181				15,3	led	2070	IP65	135	B
Led cover led-N RU	54691				15,3	led	2070	IP65	135	B
Led EM cover EM led-N RU	50191				15,3	led	2070	IP65	135	B
EL cover EL RU	64631				1x26	G24q-3	1800	IP65	69	A
EM cover EM RU	60311				1x26	G24q-3	1800	IP65	69	A

Colore base *Frame color*

BL RAL 5017 Blu <i>Blue</i>	GI RAL 1023 Giallo <i>Yellow</i>	RO RAL 3000 Rosso <i>Red</i>	TR Trasparente <i>Transparent</i>
---------------------------------------	--	--	---

● Nuova versione *New version*

- Led Equipaggiata con led 3000K - *Equipped with led 3000K*
- Led Equipaggiata con led 4000K - *Equipped with led 4000K*
- Led EM Led EM EM Emergenza (SA) 1h di serie – 3h a richiesta. *Emergency 1h standard – 3h on request*

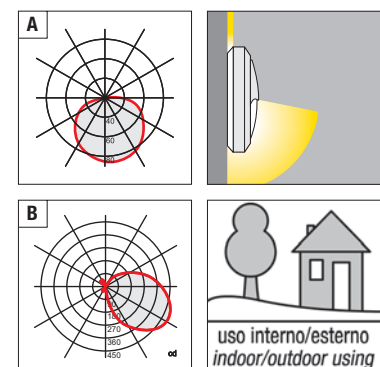



Band

Lampada da parete e da soffitto. Diffusore in policarbonato opale. Struttura in pressofusione di alluminio, verniciatura in polvere poliestere con trattamento di fosfatazione. Viti in acciaio inox. Guarnizioni in gomma ai polimeri. **Versione LED equipaggiata con led smd e alimentatore elettronico incorporato.**

Wall and ceiling lamp. Diffuser made in opal polycarbonate. Structure made in die casting aluminium with polyester paint and phosphate treatment. Inox steel screws. Gasket made in rubber. **LED version equipped with smd led and electronic driver included.**

Lampe à mur et à plafond. Diffuseur en polycarbonate opale. Structure réalisée en fonte d'aluminium. Vernis polyester et traitement de phosphatation. Vis en acier inox. Joint en gomme. **Version LED équipée avec led smd et ballast électronique incorporé.**

Lámpara de pared y de techo. Difusor de policarbonato opal. Estructura en fundición a presión de aluminio, pintura en polvo poliéster con tratamiento de fosfatación. Tornillos de acero inoxidable. Junta de protección de goma. **Version LED suministrada con led smd y alimentador electrónico incluido.**

Wand- und Deckenleuchte. Diffusor aus opalem Polycarbonat. Struktur aus Aludruckguss, Lackierung aus Polyester Pulver mit Phosphatierung. Schrauben aus Edelstahl. Dichtungen aus Polymergummi. **Ausführung LED zum led smd und integriert Versorgungsgerät elektronisch.**

Band

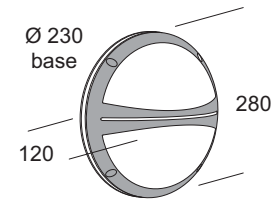

Colore struttura Structure color

Articolo Item	Colore struttura Structure color			W _{max}	LUMEN	LUMEN/W	LUMEN/W	LUMEN/W
	AT	GR	RU					
E27 band	51187	51186	51188	1x22 FBT	E27	1440	IP54	⊕ 65 A
Led band led-W	55607	55606	55608	15,3	led	2070	IP54	⊕ 135 B
Led band led-N	55617	55616	55618	15,3	led	2070	IP54	⊕ 135 B



Colore struttura Structure color

● Nuova versione New version

- AT** RAL 7016
Antracite gofrato Embossed anthracite
- GR** RAL 9006
Grigio gofrato Embossed grey
- **RU**
Ruggine Rust

- Led** Equipaggiata con led 3000K - Equipped with led 3000K
- Led** Equipaggiata con led 4000K - Equipped with led 4000K

A

B

uso interno/esterno
indoor/outdoor using

14 applique interni/esterni
wall lights indoor/outdoor

150 plafoniere interni/esterni
ceiling bowls indoor/outdoor

248 testata letto
bed head units

258 sospensioni
suspensions

344 lampade
lamps

384 lampioni ed incassi
bollards & recessed lights

450 indice
index



Kros

Lampada da parete e da soffitto. Diffusore in policarbonato opale. Struttura in pressofusione di alluminio, verniciatura in polvere poliestere con trattamento di fosfatazione. Viti in acciaio inox. Guarnizioni in gomma ai polimeri. **Versione LED equipaggiata con led smd e alimentatore elettronico incorporato.**

Wall and ceiling lamp. Diffuser made in opal polycarbonate. Structure made in die casting aluminium with polyester paint and phosphate treatment. Inox steel screws. Gasket made in rubber. **LED version equipped with smd led and electronic driver included.**

Lampe à mur et à plafond. Diffuseur en polycarbonate opale. Structure réalisée en fonte d'aluminium. Vernis polyester et traitement de phosphatation. Vis en acier inox. Joint en gomme. **Version LED équipée avec led smd et ballast électronique incorporé.**

Lámpara de pared y de techo. Difusor de policarbonato opal. Estructura en fundición a presión de aluminio, pintura en polvo poliéster con tratamiento de fosfatación. Tornillos de acero inoxidable. Junta de protección de goma. **Version LED suministrada con led smd y alimentador electrónico incluido.**

Wand- und Deckenleuchte. Diffusor aus opalem Polycarbonat. Struktur aus Aludruckguss, Lackierung aus Polyester Pulver mit Phosphatierung. Schrauben aus Edelstahl. Dichtungen aus Polymergummi. **Ausführung LED zum led smd und integriert Versorgungsgerät elektronisch.**

Kros

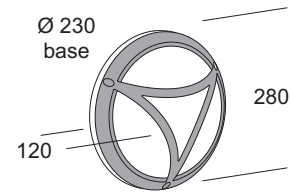

Colore struttura Structure color

Articolo Item	Colore struttura Structure color			W _{max}	Beam	LUMEN	IP	LUMEN/W	Energy
	AT	GR	RU						
E27 kros	51177	51176	51178	1x22 FBT	E27	1440	IP54	65	A
● Led kros led-W	55627	55626	55628	15,3	led	2070	IP54	135	B
● Led kros led-N	55637	55636	55638	15,3	led	2070	IP54	135	B

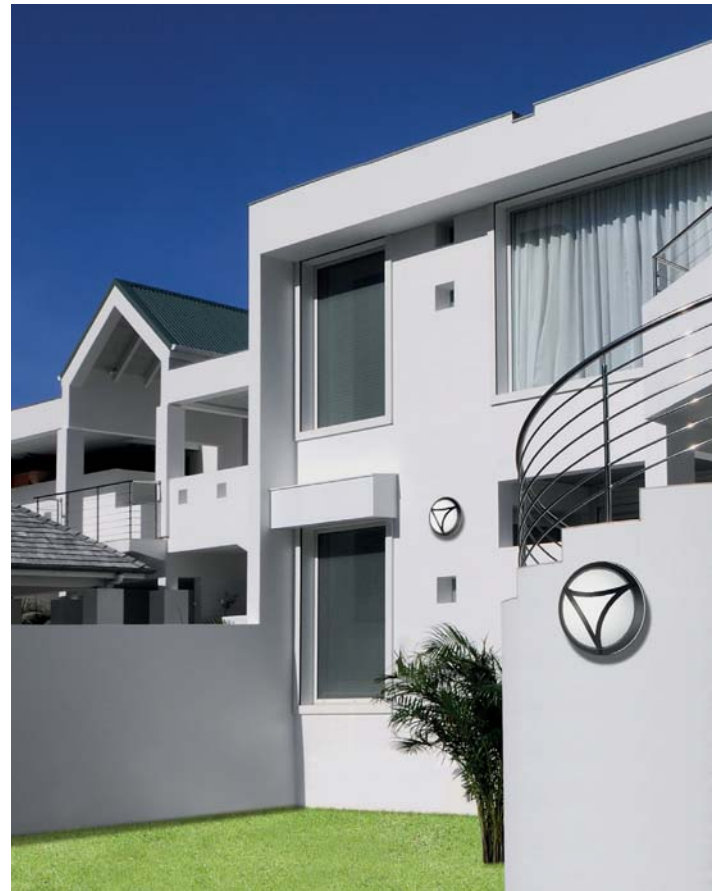

Colore struttura Structure color

● Nuova versione New version

AT RAL 7016
Antracite gofrato Embossed anthracite

GR RAL 9006
Grigio gofrato Embossed grey

● **RU**
Ruggine Rust

● Led Equipaggiata con led 3000K - Equipped with led 3000K

● Led Equipaggiata con led 4000K - Equipped with led 4000K

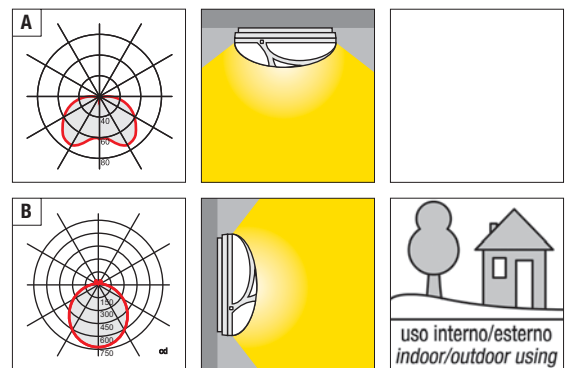



Asso

Lampada da parete e da soffitto. Diffusore in policarbonato opale. Struttura in pressofusione di alluminio, verniciatura in polvere poliestere con trattamento di fosfatazione. Viti in acciaio inox. Guarnizioni in gomma ai polimeri. **Versione LED equipaggiata con led smd e alimentatore elettronico incorporato.**

Wall and ceiling lamp. Diffuser made in opal polycarbonate. Structure made in die casting aluminium with polyester paint and phosphate treatment. Inox steel screws. Gasket made in rubber. **LED version equipped with smd led and electronic driver included.**

Lampe à mur et à plafond. Diffuseur en polycarbonate opale. Structure réalisée en fonte d'aluminium. Vernis polyester et traitement de phosphatation. Vis en acier inox. Joint en gomme. **Version LED équipée avec led smd et ballast électronique incorporé.**

Lámpara de pared y de techo. Difusor de policarbonato opal. Estructura en fundición a presión de aluminio, pintura en polvo poliéster con tratamiento de fosfatación. Tornillos de acero inoxidable. Junta de protección de goma. **Version LED suministrada con led smd y alimentador electrónico incluido.**

Wand- und Deckenleuchte. Diffusor aus opalem Polycarbonat. Struktur aus Aludruckguss, Lackierung aus Polyester Pulver mit Phosphatierung. Schrauben aus Edelstahl. Dichtungen aus Polymergummi. **Ausführung LED zum led smd und integriert Versorgungsgerät elektronisch.**

Asso

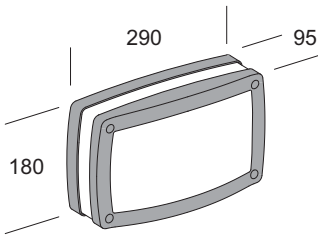

Colore struttura Structure color

Articolo Item	Colore struttura Structure color			W _{max}		LUMEN		LUMEN/W	
	AT	GR	RU						
● E27 asso	51247	51246	51248	1x20 FBT	E27	1200	IP54	⊕ 60	A
● Led asso led-W	55657	55656	55658	12,6	led	1500	IP54	⊕ 119	B
● Led asso led-N	55667	55666	55668	12,6	led	1500	IP54	⊕ 119	B
EL asso EL	58347	58346	58348	1x26 G24q-3		1800	IP54	⊕ 69	A



Colore struttura Structure color

● Nuova versione New version

AT **RAL 7016**
Antracite gofrato Embossed anthracite

GR **RAL 9006**
Grigio gofrato Embossed grey

● RU
Ruggine Rust

Led Equipaggiata con led 3000K - Equipped with led 3000K

Led Equipaggiata con led 4000K - Equipped with led 4000K

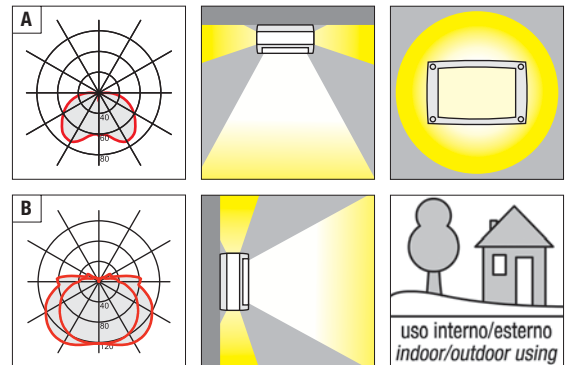



Polo - Riga

Lampada da parete. Diffusore in policarbonato opale. Struttura in pressofusione di alluminio, verniciatura in polvere poliester con trattamento di fosfatazione. Viti in acciaio inox. Guarnizioni in gomma ai polimeri. **Versione LED equipaggiata con led smd.**

Wall lamp. Diffuser made in opal polycarbonate. Structure made in die casting aluminium with polyester paint and phosphate treatment. Inox steel screws. Gasket made in rubber. **LED version equipped with smd led.**

Lampe à mur. Diffuseur en polycarbonate opale. Structure réalisée en fonte d'aluminium. Vernis polyester traitement de phosphatation. Vis en acier inox. Joint en gomme. **Version LED équipée avec led smd.**

Lámpara de pared. Difusor de policarbonato opal. Estructura en fundición a presión de aluminio, pintura en polvo poliéster con tratamiento de fosfatación. Tornillos de acero inoxidable. Junta de protección de goma. **Version LED suministrada con led smd.**

Wandleuchte. Diffusor aus opalem Polycarbonat. Struktur aus Aludruckguss, Lackierung aus Polyesterpulver mit Phosphatierung. Schrauben aus Edelstahl. Dichtungen aus Polymergummi. **LED Version Ausgestattet mit led smd.**



Polo

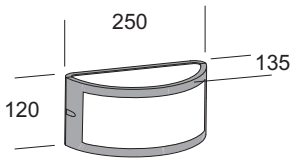

Colore struttura Structure color

AT GR RU
Codice Code

W_{max}



LUMEN



LUMEN/W



Articolo Item	AT	GR	RU	W _{max}	Bulb	LUMEN	IP	Energy	LUMEN/W	Class
E27 polo	61747	61746	61748	1x46	E27	700	IP54	⊕	15	A
● Led polo led-W	54707	54706	54708	13,5 (a)	led	1500	IP54	⊕	111	A
● Led polo led-N	54717	54716	54718	13,5 (a)	led	1500	IP54	⊕	111	A

Riga

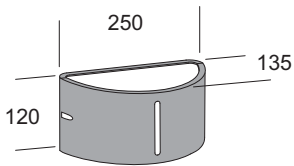

Articolo Item	AT	GR	RU	W _{max}	Bulb	LUMEN	IP	Energy	LUMEN/W	Class
E27 riga	61757	61756	61758	1x46	E27	700	IP54	⊕	15	B
● Led riga led-W	54727	54726	54728	13,5 (a)	led	1500	IP54	⊕	111	B
● Led riga led-N	54737	54736	54738	13,5 (a)	led	1500	IP54	⊕	111	B



Colore struttura Structure color

AT **RAL 7016**
Antracite gofrato Embossed anthracite

GR **RAL 9006**
Grigio gofrato Embossed grey

● **RU**
Ruggine Rust

● Nuova versione New version

● Led Equipaggiata con led 3000K - Equipped with led 3000K

● Led Equipaggiata con led 4000K - Equipped with led 4000K

(a) Compatibile con dimmer a taglio di fase (TRIAC)
Compatible with phase cut dimmer (TRIAC)

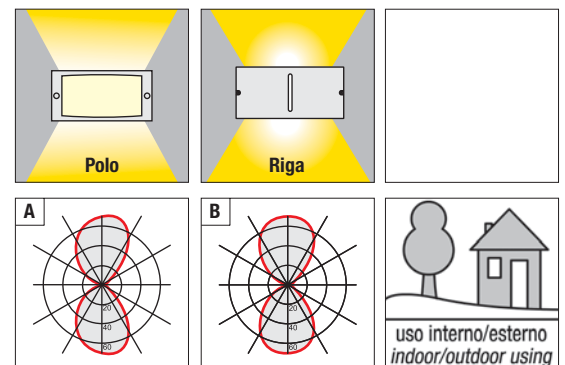

Plafoniere interni/esterni - Ceiling bows indoor/outdoor

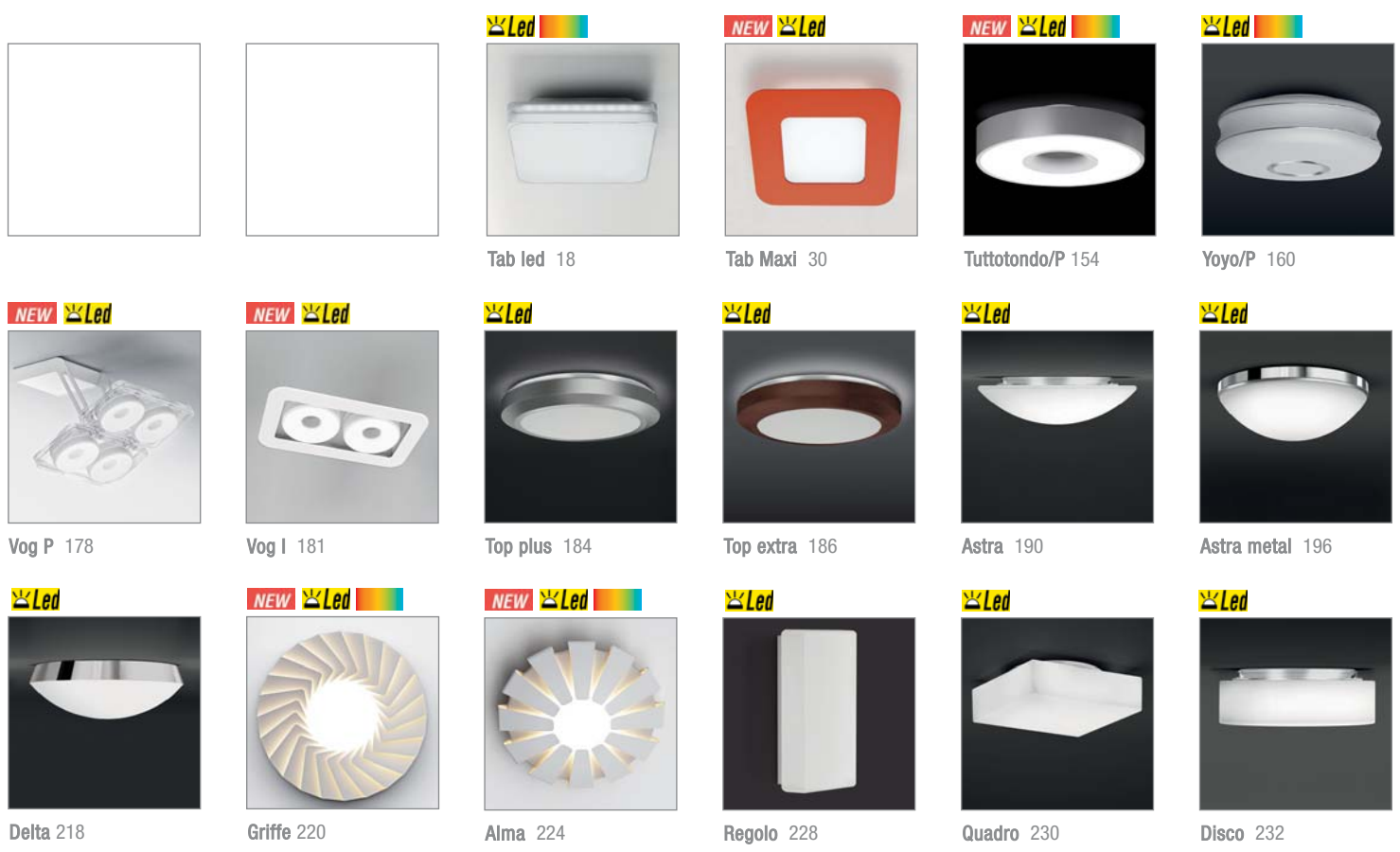

NEW Led

NEW Led

NEW Led

NEW Led

NEW Led

NEW Led

NEW Led

NEW Led

NEW Led

NEW Led

NEW Led

NEW Led

NEW Led

NEW Led

NEW Led

NEW Led

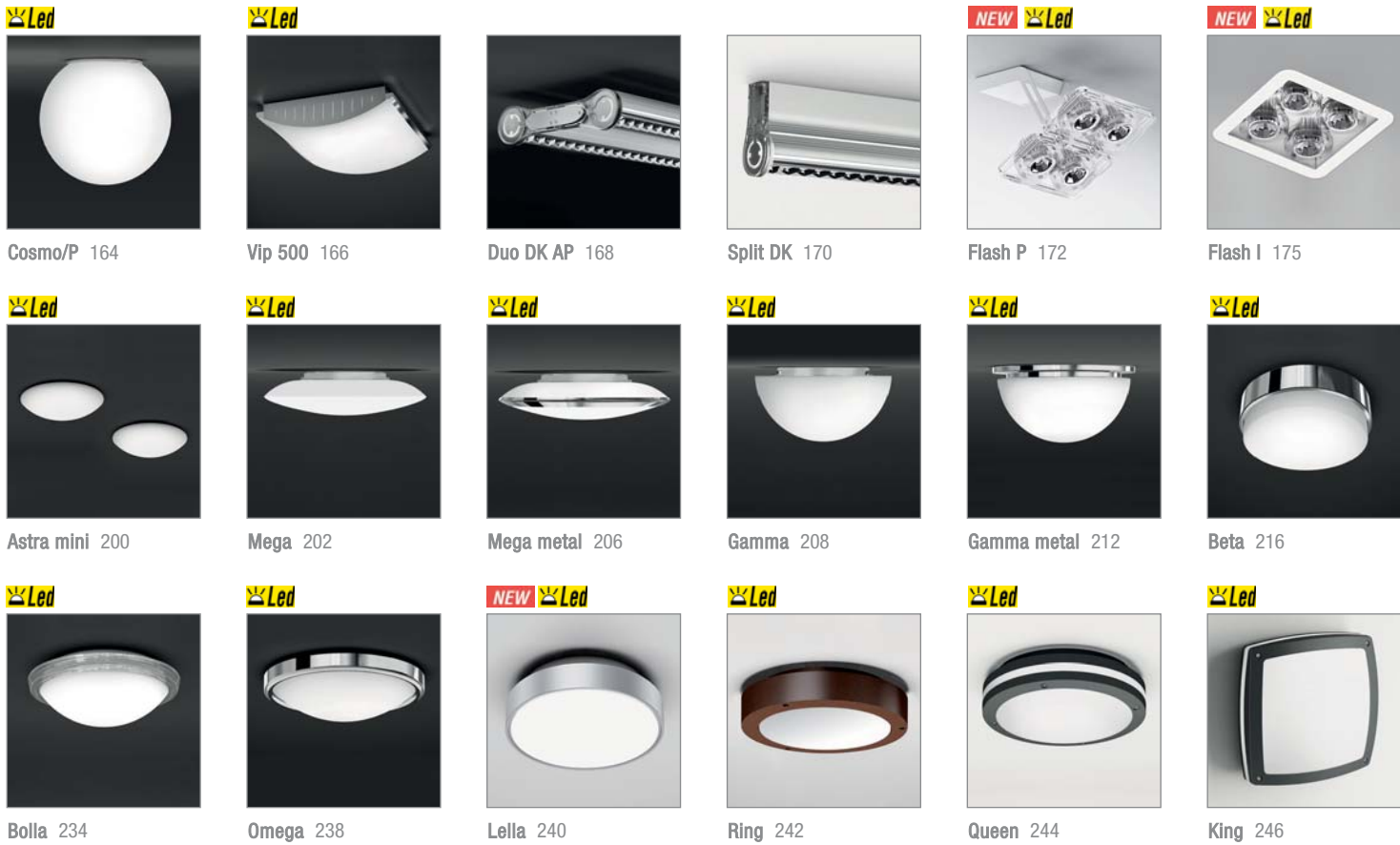



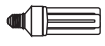
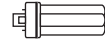

NEW Nuovo prodotto *New product*

Led Versione LED *LED version*

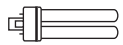
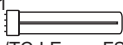
 Versione RGB *RGB version*

ARTICOLO/ITEM	PAG/PAGE	E27 				E27 					Gx24d/Gx24q 			
		A60		IAA		TC-EL		FBT			TC-T/TC-TE		FSMH	
		1 X	2 X	4 X	6 X	1 X	2 X	4 X	6 X	8 X	1 X	2 X	4 X	6 X
ALMA	224		46	3x46			20	3x20				32		
ASTRA	190	46/77	46/57			18/20	20/22					32/42		
ASTRA METAL	196	77	46/57			20	20/22							
ASTRA MINI	200					22								
BETA	216	77				22								
BOLLA	234	46/77	46			18/22	20							
COSMO/P	164	77/116				20/22					42	42		
DELTA	218		46			20								
DISCO	232	46/77				18/20								
DUO DK AP	168													
FLASH I	172													
FLASH P	172													
GAMMA	208	46	46/57			18	20/22					32		
GAMMA METAL	212	46	46/57			18	20/22							
GRIFFE	220		46	3x46			20	3x20				32		
KING	246						20							
LELLA	240					18	23							
MEGA	202	46/57	46			18/20	22							
MEGA METAL	206	46/57	46			18/20	22							
OMEGA	238	77	46/77			20	20/22							
QUADRO	230	46/77				18/20								
QUEEN	244						20							
REGOLO	228	46	46			20	20							
RING	242	77				22								
SPLIT DK	170													
TOP PLUS	184	77				20								
TOP EXTRA	186	77				20								
TUTTOTONDO P	154								23	23				
TUTTOTONDO PRGB	154													
VIP 500	166													
VOG I	178													
VOG P	178													
YOYO P	160			57	57			23	23				42	42
YOYO P RGB	160											42		

G24d/G24q 					2G11 		G5 			LED 	RGB 	EMERGENZA EMERGENCY	PAG/PAGE	ARTICOLO/ITEM	
TC-D/TC-DE					FSQ		TC-L/TC-LE		FSD	T5	FDH				
1 X	2 X	3 X	6 X	8 X	2 X	4 X	1 X	2 X	4 X						
	26										15,3/21,7	28	○	224	ALMA
18/26	18/26										8,3...23,2		○	190	ASTRA
18/26	18/26										10,5...23,2		○	196	ASTRA METAL
26											8,33			200	ASTRA MINI
18/26											10,5		○	216	BETA
18/26	18										8,33...15,5		○	234	BOLLA
											14,9			164	COSMO/P
26	18										15,5		○	218	DELTA
18/26											8,33/10,5		○	232	DISCO
								24/39	24/39				○	168	DUO DK AP
											7,1/14,2/ 28,4			172	FLASH I
											28,4			172	FLASH P
26	18/26										8,33...23,2		○	208	GAMMA
26	18/26										8,33...23,2		○	212	GAMMA METAL
	26										15,3/21,7	28	○	220	GRIFFE
	18										15,3		○	246	KING
18	26										10...17		○	240	LELLA
26	18										8,33/15,5		○	202	MEGA
26	18										8,33/15,5		○	206	MEGA METAL
	18/26										8,33/15,5		○	238	OMEGA
18/26											8,33/10,5		○	230	QUADRO
	18										15,3		○	244	QUEEN
18	18										6,2/11,5		○	228	REGOLO
18	26										10,5/15,3		○	242	RING
							24/39 54/80	24/39 54/80					○	170	SPLIT DK
26	26										15,3		○	184	TOP PLUS
26	26										15,3		○	186	TOP EXTRA
			26	26							76,5/122,4		○	154	TUTTOTONDO P
			26	26								12/18		154	TUTTOTONDO P RGB
					36	36					23/46		○	166	VIP 500
											6/12/24			178	VOG I
											24			178	VOG P
											34,1/46,5		○	160	YOYO P
											15,3	20		160	YOYO P RGB





Tuttotondo P

Lampada da soffitto o parete per illuminazione di ambienti con luce diretta e indiretta. Diffusori in policarbonato colore anice. Struttura in metallo calandrato e verniciato con la superficie interna riflettente. Montatura in metallo verniciato bianco ral 9016. Tutte le lampade sono cablate con doppia accensione separata. **Versione LED equipaggiata con led smd e alimentatore elettronico incorporato. La finitura può cambiare a richiesta del cliente.**

Ceiling or wall lamp to illuminate with direct and indirect light. Diffusers made in polycarbonate anise colour. Structure made in curved painted metal with inside reflecting surface. Frame made in metal white painted ral 9016. **LED version equipped with smd led and electronic driver included. Finish can change based on client request.**

Lampe à plafond ou à mur pour éclairage avec lumière directe et indirecte. Diffuseurs en polycarbonate couleur anis. Structure réalisé en métal incurvé et verni avec la surface interne réfléchissante. Monture en métal verni blanc ral 9016. Toutes les lampes sont équipées avec allumage double séparée. **Version LED équipée avec led smd et ballast électronique incorporé. La finition peu changé selon la demande du client.**

Lámpara de techo o pared para iluminación de ambientes con luz directa e indirecta. Difusores de policarbonato color anís. Estructura de metal curvado y pintado con superficie interna reflectante. Montadura de metal pintado blanco ral 9016. Todas las lámparas están cableadas para doble encendido separado. **Versión LED suministrada con led smd y alimentador electrónico incluido. Acabado puede cambiar a petición del cliente.**

Decken- oder Wandleuchte zur Beleuchtung von Räumen mit direktem und indirektem Licht. Diffusoren aus anisfarbenem Polycarbonat. Struktur aus gebogenem und lackiertem Metall mit reflektierender Innenfläche. Fassung aus weiß lackiertem Metall Ral 9016. Alles Hängeleuchten sind für das doppelte getrennte Einschalten verkabelt. **Ausführung LED zum led smd und integriert Versorgungsgerät elektronisch. Die Farben können auf die Bedürfnisse des Kunden abgestimmt werden.**

Tuttotondo P600		Articolo Item	Colore struttura Structure color			W _{max}		LUMEN		LUMEN/W	
			AL	BI	NE						
		E27 tuttotondo P600	11156	11151	11157	6x23 FBT	E27	9000	IP20	⊕	65 A
		EL tuttotondo P600 EL	28656	28651	28657	6x26	G24q-3	10800	IP20	⊕	69 A
		DM tuttotondo P600 DM	28666	28661	28667	6x26	G24q-3	10800	IP20	⊕	69 A
		EM tuttotondo P600 EM	14786	14781	14787	6x26	G24q-3	10800	IP20	⊕	69 A
	Led tuttotondo P600 led-W	15606	15601	15607	76,5	led	10350	IP20	⊕	135 B	
	Led DM tuttotondo P600 DM led-W	15626	15621	15627	76,5	led	10350	IP20	⊕	135 B	
	Led EM tuttotondo P600 EM led-W	14746	14741	14747	76,5	led	10350	IP20	⊕	135 B	
	Led tuttotondo P600 led-N	15616	15611	15617	76,5	led	10350	IP20	⊕	135 B	
	Led DM tuttotondo P600 DM led-N	15636	15631	15637	76,5	led	10350	IP20	⊕	135 B	
	Led EM tuttotondo P600 EM led-N	14756	14751	14757	76,5	led	10350	IP20	⊕	135 B	

Colore struttura Structure color

AL RAL 9006 Alluminio Aluminium	BI RAL 9016 Bianco opaco Matt white	NE RAL 9005 Nero opaco Matt black
---	---	---

- Led** Equipaggiata con led 3000K - Equipped with led 3000K
- Led** Equipaggiata con led 4000K - Equipped with led 4000K
- Led DM** **Led DM** **DM** Dimmerabile PUSH/DALI
Dimmable PUSH/DALI (info page10)
- Led EM** **Led EM** **EM** Emergenza (SA) 1h di serie – 3h a richiesta
Emergency 1h standard – 3h on request

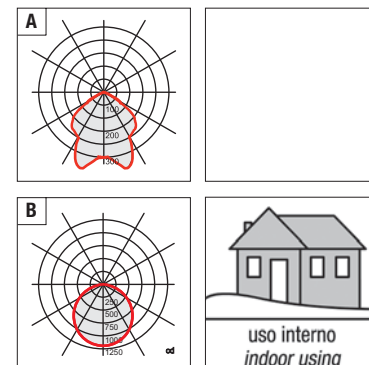

Tuttotondo P900

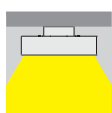
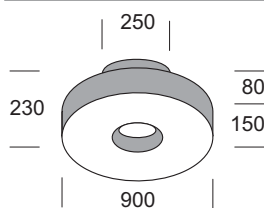

Articolo Item	Colore struttura Structure color			W _{max}	E27	LUMEN	IP	LUMEN/W	Icon
	AL	BI	NE						
	Codice Code								
E27 tuttotondo P900	11166	11161	11167	8x23 FBT	E27	12000	IP20	⊕	65 A
EL tuttotondo P900 EL	28676	28671	28677	8x26	G24q-3	14400	IP20	⊕	69 A
DM tuttotondo P900 DM	28686	28681	28687	8x26	G24q-3	14400	IP20	⊕	69 A
EM tuttotondo P900 EM	14816	14811	14817	8x26	G24q-3	14400	IP20	⊕	69 A
Led tuttotondo P900 led-W	15646	15641	15647	122,4	led	16560	IP20	⊕	135 B
Led DM tuttotondo P900 DM led-W	15666	15661	15667	122,4	led	16560	IP20	⊕	135 B
Led EM tuttotondo P900 EM led-W	14766	14761	14767	122,4	led	16560	IP20	⊕	135 B
Led tuttotondo P900 led-N	15656	15651	15657	122,4	led	16560	IP20	⊕	135 B
Led DM tuttotondo P900 DM led-N	15676	15671	15677	122,4	led	16560	IP20	⊕	135 B
Led EM tuttotondo P900 EM led-N	14776	14771	14777	122,4	led	16560	IP20	⊕	135 B

Colore struttura Structure color

AL RAL 9006 Alluminio Aluminium	BI RAL 9016 Bianco opaco Matt white	NE RAL 9005 Nero opaco Matt black
--	--	--

Led Equipaggiata con led 3000K - Equipped with led 3000K

Led Equipaggiata con led 4000K - Equipped with led 4000K

Led DM **Led DM** **DM** Dimmerabile PUSH/DALI
Dimmable PUSH/DALI (info page10)

Led EM **Led EM** **EM** Emergenza (SA) 1h di serie – 3h a richiesta
Emergency 1h standard – 3h on request

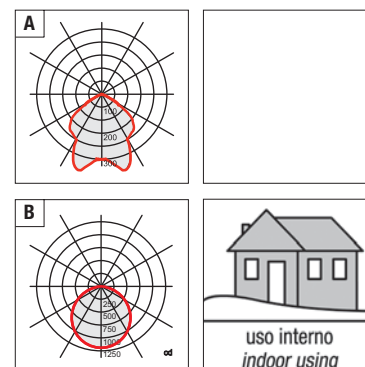



Tuttotondo P-RGB

La versione RGB per missaggio di luci colorate è equipaggiata con LED smd Full Color, alimentatore elettronico e modulo per controllo ciclo colore incorporati. La versione RGB è equipaggiata anche con lampade fluorescenti bianche per illuminazione diretta e indiretta. **La finitura può cambiare a richiesta del cliente.**

RGB version for coloured lights mixing is equipped with LED smd Full Color, electronic gear included to control colour cycle. RGB version is also equipped with white fluorescent bulbs for direct and indirect light. **Finish can change based on client request.**

Version RGB pour mixage de lumières colorées est équipée avec LED smd Full Color, ballast électronique incorporé pour contrôler le cycle des couleurs. La version RGB est aussi équipée avec ampoules fluorescent blanc pour lumière directe et indirecte. **La finition peu changé selon la demande du client.**

Versión RGB para mezclar las luces coloreadas es suministrada con LED smd Full Color, alimentador electrónico incorporado con módulo para el control del ciclo de color. La versión RGB es suministrada también con lamparas fluorescente blancas b para una luz dirceta y indirecta. **Acabado puede cambiar a petición del cliente.**

Ausführung RGB zur Mischung bunter Lichter Ausführung zum LED smd Full Color, elektronisches Versorgungsgerät mit Modul zur Farbzykluskontrolle integriert. Ausführung RGB auch zum weiß Leuchtstofflampen ausgerüstet für direktem und indirektem Licht. **Die Farben können auf die Bedürfnisse des Kunden abgestimmt werden.**

Colore struttura Structure color

Tuttotondo P600 RGB

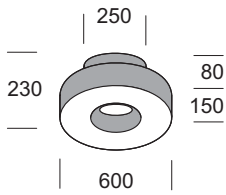

Articolo Item

AL BI **NE** W_{max} LUMEN LUMEN/W



Codice Code

Articolo Item	Codice Code	W _{max}	LUMEN	LUMEN/W	Other
DMDIG tuttotondo P600 DM RGB DIG	14796 14791 14797	6x26 12	G24q-3 led RGB	10800 720	IP20 ⚡ 69 A (nd)
DMDALI tuttotondo P600 DM RGB DALI	14806 14801 14807	6x26 12	G24q-3 led RGB	10800 720	IP20 ⚡ 69 A (nd)

Tuttotondo P900 RGB

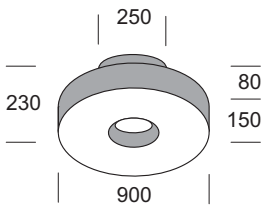

Articolo Item	Codice Code	W _{max}	LUMEN	LUMEN/W	Other
DMDIG tuttotondo P900 DM RGB DIG	14826 14821 14827	8x26 18	G24q-3 led RGB	14400 1080	IP20 ⚡ 69 A (nd)
DMDALI tuttotondo P900 DM RGB DALI	14836 14831 14837	8x26 18	G24q-3 led RGB	14400 1080	IP20 ⚡ 69 A (nd)

Colore struttura Structure color

AL RAL 9006
Alluminio Aluminium

BI RAL 9016
Bianco opaco Matt white

NE RAL 9005
Nero opaco Matt black

DMDIG Miscelazione colore RGB digitale + Fluo Dimmerabile PUSH
Digital color mixing RGB + Fluo Dimmable PUSH (info page 10)

DMDALI Miscelazione colore RGB DALI + Fluo Dimmerabile DALI
DALI color mixing RGB + Fluo Dimmable DALI (info page 10)

(nd) Non disponibile - Not available

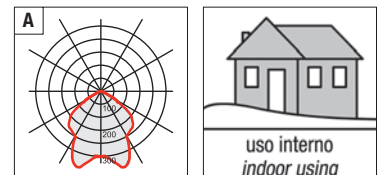
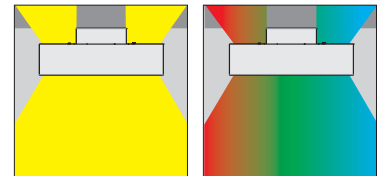



YoYo P

Lampada da parete e da soffitto per illuminazione di ambienti con luce diffusa. Diffusore stampato rotazionale in polietilene bianco. Particolari colore bianco o con finitura cromata. Montatura in metallo verniciato bianco ral 9016. La plafoniera diametro 900 mm è cablata per doppia accensione separata (4+2).
Versione LED equipaggiata con led smd e alimentatore elettronico incorporato.

Wall and ceiling lamp to illuminate with diffused light. Diffuser rotational moulded, realized in white polyethylene. Details coloured white or chrome finish. Frame made of white painted metal, ral 9016. The ceiling diameter 900 mm is cabled for double separate lighting-up (4+2).
LED version equipped with smd led and electronic driver included.

Lampe à mur et à plafond pour éclairage avec lumière diffuse. Diffuseur moulé rotatif, en polyéthylène blanc. Détail couleur blanc ou avec finition chromé. Monture en métal verni blanc, ral 9016. La plafonnier diamètre 900 mm est câblée pour double allumage séparé (4+2).
Version LED équipée avec led smd et ballast électronique incorporé.

Lámpara de pared y de techo para iluminación de ambientes con luz difusa. Pantalla difusora moldeado rotacional de polietileno blanco. Detalles color blanco o con acabado cromado. Montadura de metal pintado blanco ral 9016. La versión diámetro 900 mm está cableada para doble encendido separado (4+2).
Version LED suministrada con led smd y alimentador electrónico incluido.

Wand- und Deckenleuchte zur Beleuchtung von Räumen mit diffusem Licht. Formgestanzter Rotationsdiffusor aus weißem polyethylen. Die Einzelteile sind weiß oder verchromt. Die Metallstruktur ist weiß lackiert, gemäß RAL 9016. Die Deckenleuchten mit Durchmesser 900 mm verfügt über eine Verkabelung für eine zweifache, getrennte Einschaltvorrichtung (4+2).
Ausführung LED zum led smd und integriert Versorgungsgerät elektronisch.

YoYo P600

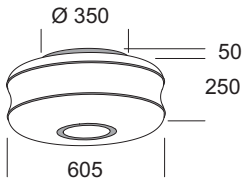

Articolo <i>Item</i>	Colore decoro <i>Details color</i>		W _{max}	E27	LUMEN	IP	LUMEN/W	A
	BI Codice	CR Code						
E27 yoyo P600	12251	12250	4x57	E27	3660	IP20	⊕ 16	A
● Led yoyo P600 led-W	15761	15760	34,1	led	3550	IP20	⊕ 104	C
● Led DM yoyo P600 DM led-W	15781	15780	34,1	led	3550	IP20	⊕ 104	C
● Led EM yoyo P600 EM led-W	14881	14880	34,1	led	3550	IP20	⊕ 104	C
● Led yoyo P600 led-N	15771	15770	34,1	led	3550	IP20	⊕ 104	C
● Led DM yoyo P600 DM led-N	15791	15790	34,1	led	3550	IP20	⊕ 104	C
● Led EM yoyo P600 EM led-N	14891	14890	34,1	led	3550	IP20	⊕ 104	C
EL yoyo P600 EL	18581	18580	4x42(a)	GX24q-4	12800	IP20	⊕ 76	A
DM yoyo P600 DM	18891	18890	4x42	GX24q-4	12800	IP20	⊕ 76	A
EM yoyo P600 EM	10701	10700	4x42(a)	GX24q-4	12800	IP20	⊕ 76	A

YoYo P900

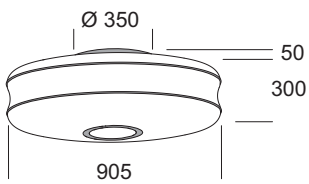

E27 yoyo P900	12261	12260	6x57	E27	5490	IP20	⊕ 16	B
● Led yoyo P900 led-W	15841	15840	46,5	led	5580	IP20	⊕ 120	C
● Led DM yoyo P900 DM led-W	15861	15860	46,5	led	5580	IP20	⊕ 120	C
● Led EM yoyo P900 EM led-W	14901	14900	46,5	led	5580	IP20	⊕ 120	C
● Led yoyo P900 led-N	15851	15850	46,5	led	5580	IP20	⊕ 120	C
● Led DM yoyo P900 DM led-N	15871	15870	46,5	led	5580	IP20	⊕ 120	C
● Led EM yoyo P900 EM led-N	14911	14910	46,5	led	5580	IP20	⊕ 120	C
EL yoyo P900 EL	18601	18600	6x42(a)	GX24q-4	19200	IP20	⊕ 76	B
DM yoyo P900 DM	18911	18910	6x42	GX24q-4	19200	IP20	⊕ 76	B
EM yoyo P900 EM	10711	10710	6x42(a)	GX24q-4	19200	IP20	⊕ 76	B

Colore decoro *Details color*

BI Bianco *White* **CR** Cromato *Chrome*

● Nuova versione *New version*

Led Equipaggiata con led 3000K - *Equipped with led 3000K*

Led Equipaggiata con led 4000K - *Equipped with led 4000K*

Led DM **Led DM** **DM** Dimmerabile PUSH/DALI
Dimmable PUSH/DALI (info page 10)

Led EM **Led EM** **EM** Emergenza (SA) 1h di serie - 3h a richiesta
Emergency 1h standard - 3h on request

(a) Equipaggiato con alimentatore multipotenza per l'utilizzo di lampade da 26W-32W o 42W
Equipped with multi-power ballast to use bulbs of 26W-32W or 42W

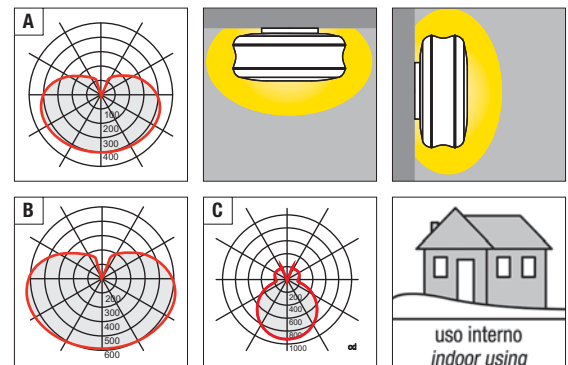



YoYo P-RGB

Lampada da soffitto per illuminazione di ambienti con luce diretta bianca e diffusa colorata RGB **con accensioni separate**. Il sistema RGB per missaggio di luci colorate è equipaggiato con LED smd Full Color, alimentatore elettronico incorporato e modulo per controllo ciclo colore. La versione DM è equipaggiata anche per lampade fluorescenti per illuminazione diretta.

Ceiling lamp to illuminate with white direct light and coloured diffused light by RGB system **with separate lightings**. RGB system for coloured lights mixing is equipped with LED smd Full Color, electronic gear included to control colour cycle. DM version is also equipped for fluorescent bulbs for direct light.

Lampe à plafond pour éclairage avec lumière directe blanc et lumière diffuse colorée avec system RGB **avec allumage séparé**. Le system RGB pour mixage de lumières colorées est équipée avec LED smd Full Color, ballast électronique incorporé pour contrôler le cycle des couleurs. La version DM est aussi équipée pour ampoule fluorescent pour lumière directe.

Lámpara de techo para iluminación de ambientes con luz directa blanca y luz difusa coloreada con sistema RGB **con encendido separado**. El sistema RGB para mezclar las luces coloreadas es suministrado con LED smd Full Color, alimentador electrónico incorporado con módulo para el control del ciclo de color. La versión DM es suministrada también para lampara fluorescente para una luz directa.

Deckenleuchte zur Beleuchtung von Räumen mit weiß direktem Licht und farbigen diffusem Licht mit RGB System **mit getrennter Einschaltvorrichtung**. Der System RGB zur Mischung bunter Lichter Ausführung zum LED smd Full Color, elektronisches Versorgungsgerät mit Modul zur Farbzykluskontrolle integriert. Ausführung DM auch für Leuchtstofflampe ausgerüstet für direkte Licht.

YoYo P600 RGB

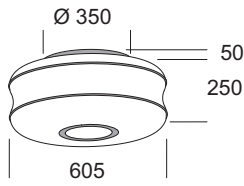

Articolo Item	Colore decoro Details color		W _{max}	LUMEN	IP	LUMEN/W	Icon
	BI	CR					
	Codice Code						
● LedDIG yoyo P600 LED-W RGB DIG	15801	15800	15,3	2070	IP20	⊕	135
			20	1200			60
● LedDALI yoyo P600 LED-W RGB DALI	15821	15820	15,3	2070	IP20	⊕	135
			20	1200			60
● LedDIG yoyo P600 LED-N RGB DIG	15811	15810	15,3	2070	IP20	⊕	135
			20	1200			60
● LedDALI yoyo P600 LED-N RGB DALI	15831	15830	15,3	2070	IP20	⊕	135
			20	1200			60
DMDIG yoyo P600 DM RGB DIG	10921	10920	2x42	6400	IP20	⊕	76
			20	1200			60
DMDALI yoyo P600 DM RGB DALI	10931	10930	2x42	6400	IP20	⊕	76
			20	1200			60

YoYo P900 RGB

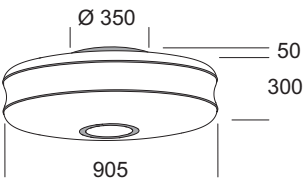

● LedDIG yoyo P900 LED-W RGB DIG	15881	15880	15,3	2070	IP20	⊕	135
			20	1200			60
● LedDALI yoyo P900 LED-W RGB DALI	15901	15900	15,3	2070	IP20	⊕	135
			20	1200			60
● LedDIG yoyo P900 LED-N RGB DIG	15891	15890	15,3	2070	IP20	⊕	135
			20	1200			60
● LedDALI yoyo P900 LED-N RGB DALI	15911	15910	15,3	2070	IP20	⊕	135
			20	1200			60
DMDIG yoyo P900 DM RGB DIG	10941	10940	2x42	6400	IP20	⊕	76
			20	1200			60
DMDALI yoyo P900 DM RGB DALI	10951	10950	2x42	6400	IP20	⊕	76
			20	1200			60

Colore decoro Details color

● Nuova versione New version

BI Bianco White **CR** Cromato Chrome

LedDIG Accensioni separate per illuminare con led 3000K e/o sistema RGB led.
LedDALI Separate lightings to illuminate with led 3000K and/or RGB led system. (info page 10)

LedDIG Accensioni separate per illuminare con led 4000K e/o sistema RGB led.
LedDALI Separate lightings to illuminate with led 4000K and/or RGB led system. (info page 10)

DMDIG Miscelazione colore RGB digitale + Fluo Dimmerabile PUSH
 Digital color mixing RGB + Fluo Dimmable PUSH (info page 10)

DMDALI Miscelazione colore RGB DALI + Fluo Dimmerabile DALI
 DALI color mixing RGB + Fluo Dimmable DALI (info page 10)

(nd) Non disponibile - Not available

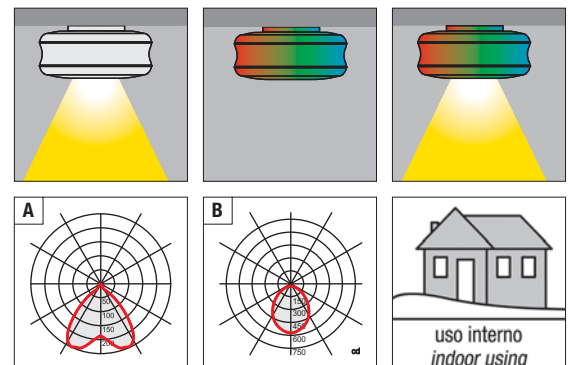

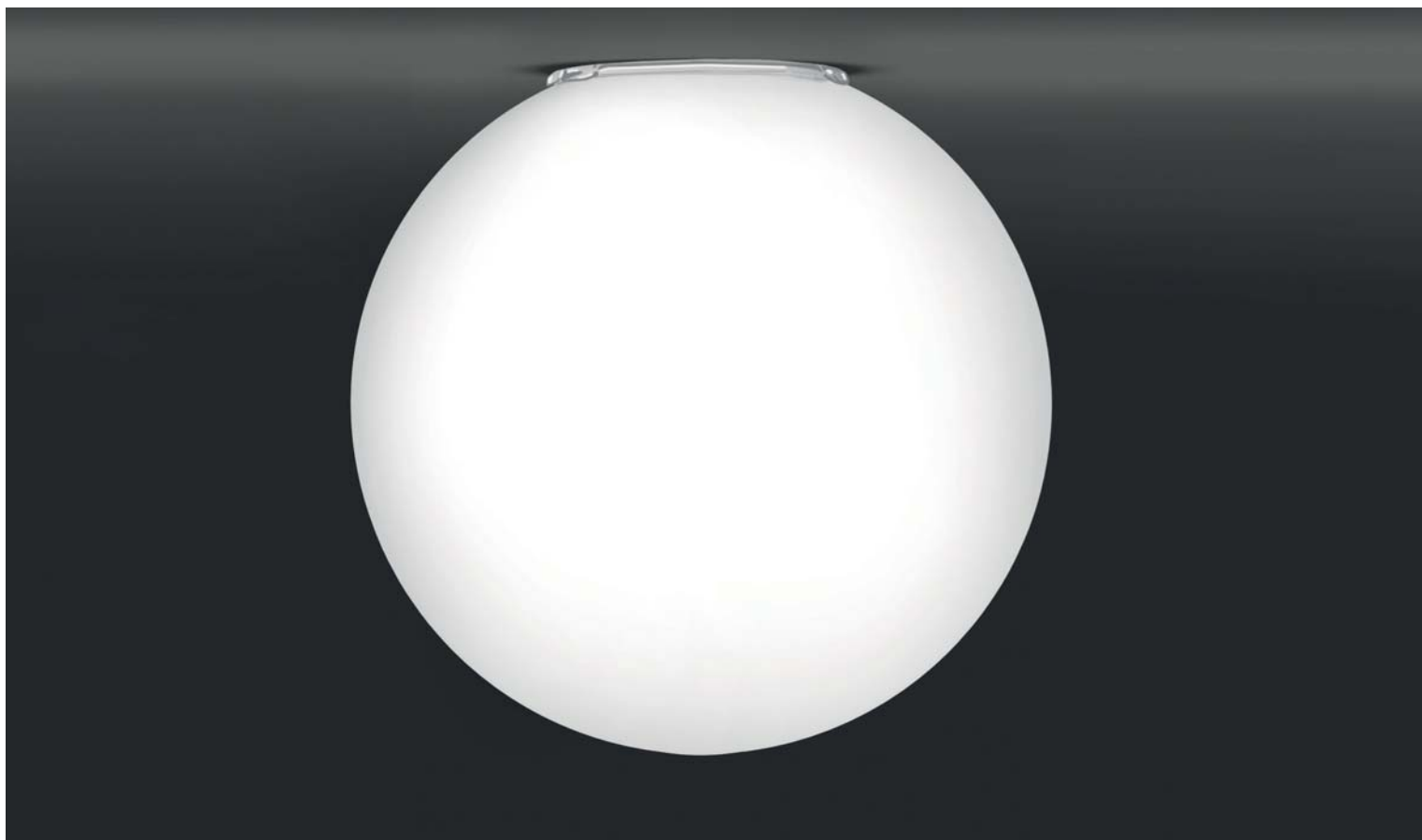

Cosmo P

Lampada da soffitto o parete. Diffusore in vetro soffiato opale triplex satinato. Anello trasparente o colorato, in policarbonato autoestinguente. Struttura interna in metallo verniciato bianco ral 9016. **Versione LED equipaggiata con led smd e alimentatore elettronico incorporato.**

Ceiling or wall lamp. Diffuser made in blown satin opal triplex glass. Transparent or coloured ring made in auto-extinguishing polycarbonate. Inside structure made in metal white painted ral 9016. **Version LED suministrada con led smd y alimentador electrónico incluido.**

Lampe à plafond ou à mur. Diffuseur en verre soufflé opale triplex satiné. Anneau transparent ou coloré, réalisé en polycarbonate auto-extinguible. Structure interne réalisée en métal vernie blanc ral 9016. **Version LED équipée avec led smd et ballast électronique incorporé.**

Lámpara de techo o pared. Difusor de vidrio soplado opal triplex satinado. Anillo transparente o de colores, en policarbonato de autoextinción. Estructura interna en metal pintado blanco ral 9016. **LED version equipped with smd led and electronic driver included.**

Decken-oder Wandleuchte. Diffusor aus geblasenem Triplex-Opalglas, satiniert. Ring transparente oder farbige, aus selbstlöschendem Polycarbonat. Interne Struktur aus weiß lackiertem Metall Ral 9016. **Ausführung LED zum led smd und integriert Versorgungsgerät elektronisch.**

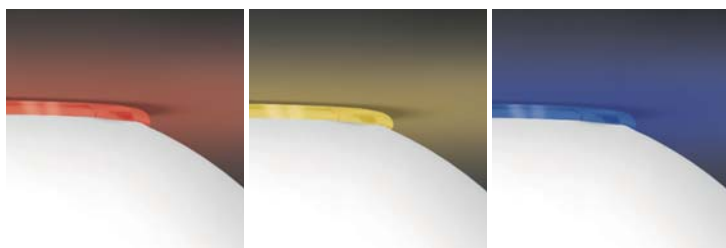

Cosmo P300

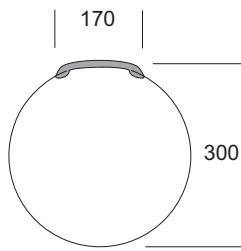

Articolo Item	Colore anello Ring color				W _{max}	E27	LUMEN	IP	LUMEN/W	Icona	
	BL	GI	RO	TR							Codice Code
E27 cosmo P300	13515	13512	13513	13510	1x77	E27	1320	IP20	□	17	A
● Led cosmo P300 led-W	15925	15922	15923	15920	14,9	led	2000	IP20	⊕	119	D
● Led cosmo P300 led-N	15935	15932	15933	15930	14,9	led	2000	IP20	⊕	119	D
EL cosmo P300 EL	18635	18632	18633	18630	1x42(a)	GX24q-4	3200	IP20	⊕	76	B

Cosmo P400

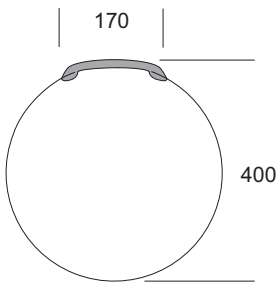

E27 cosmo P400	13525	13522	13523	13520	1x116	E27	2135	IP20	□	18	A
● Led cosmo P400 led-W	15945	15942	15943	15940	14,9	led	2000	IP20	⊕	119	D
● Led cosmo P400 led-N	15955	15952	15953	15950	14,9	led	2000	IP20	⊕	119	D
EL cosmo P400 EL/42	18645	18642	18643	18640	1x42(a)	GX24q-4	3200	IP20	⊕	76	B
cosmo P400 EL/84	18655	18652	18653	18650	2x42(a)	GX24q-4	6400	IP20	⊕	76	C
DM cosmo P400 DM/84	18835	18832	18833	18830	2x42	GX24q-4	6400	IP20	⊕	76	C

Colore anello Ring color

● Nuova versione New version

BL RAL 5017 Blu Blue	GI RAL 1023 Giallo Yellow	RO RAL 3000 Rosso Red	TR Trasparente Transparent
--------------------------------	-------------------------------------	---------------------------------	--------------------------------------

● Led Equipaggiata con led 3000K - Equipped with led 3000K

● Led Equipaggiata con led 4000K - Equipped with led 4000K

DM Dimmerabile PUSH/DALI
Dimmable PUSH/DALI (info page10)

(a) Equipaggiato con alimentatore multipotenza per l'utilizzo di lampade da 26W-32W o 42W
Equipped with multi-power ballast to use bulbs of 26W-32W or 42W

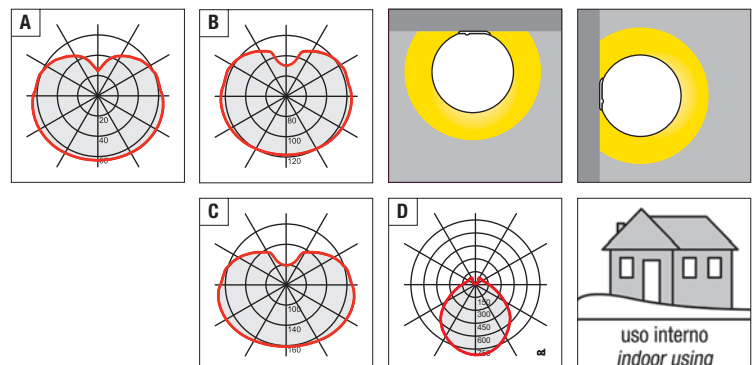

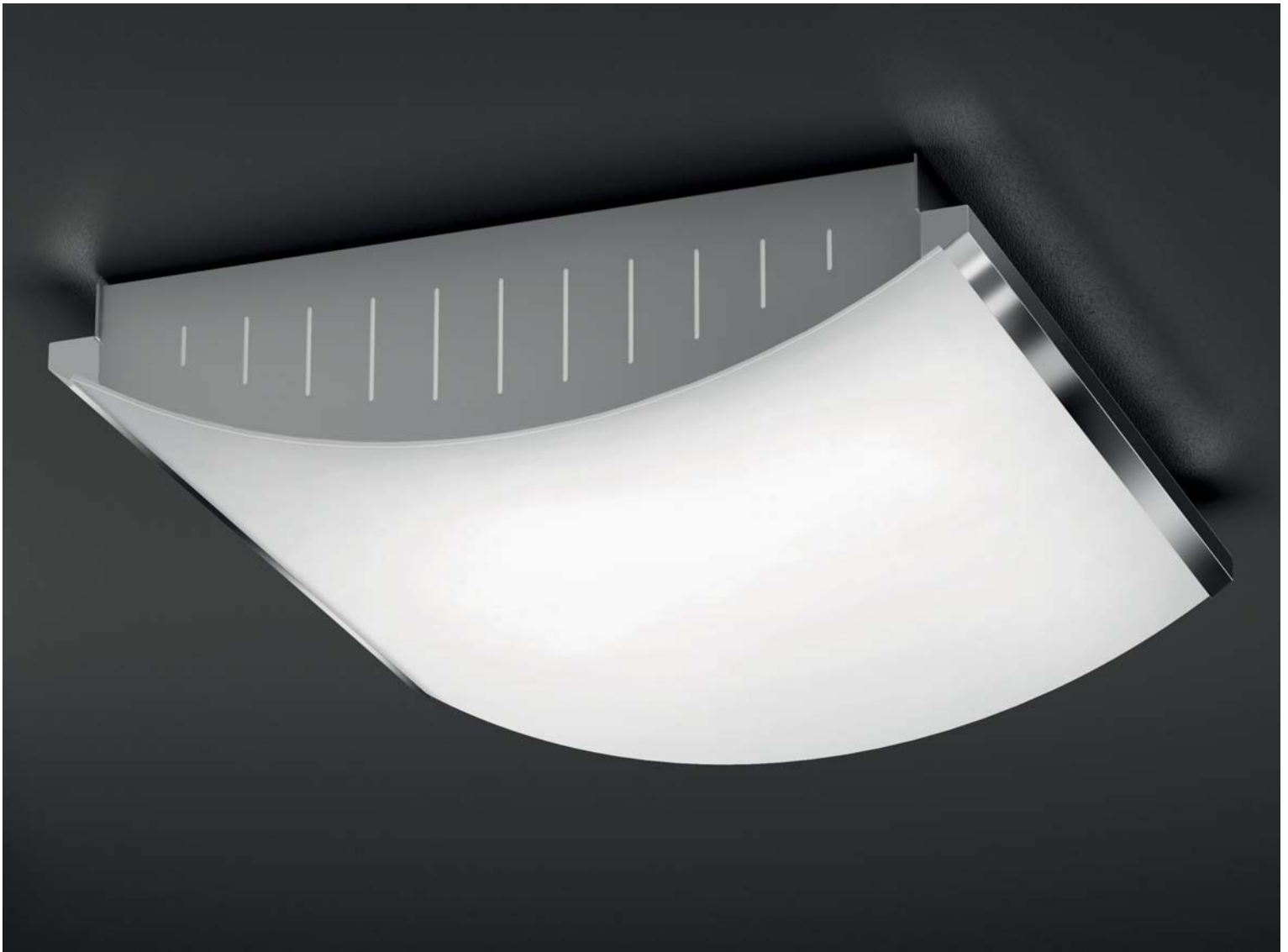

Vip

Lampada da soffitto o parete. Diffusore in vetro extrachiaro satinato bianco. Montatura in metallo verniciato bianco ral 9016. Profili laterali in metallo cromato o nickel spazzolato. Le versioni con 4 lampade sono cablate per doppia accensione separata.

Versione LED equipaggiata con led smd e alimentatore elettronico incorporato.

Ceiling or wall lamp. Diffuser made in extra-clear white satin glass. Frame made in white painted metal ral 9016. Lateral profile made in chrome plated metal or brushed nickel metal. Versions cabled with 4 bulbs are equipped with double separate lighting.

LED version equipped with smd led and electronic driver included.

Lampe à plafond ou à mur. Diffuseur en verre extra clair satiné blanc. Monture réalisée en métal vernie blanc ral 9016. Profil latéral en métal chromé ou nickel brossé. Les versions câblées avec 4 ampoules sont équipées avec allumage double séparée.

Version LED équipée avec led smd et ballast électronique incorporé.

Lámpara de techo o pared. Difusor de vidrio extraclaro satinado blanco. Montadura en metal pintado blanco ral 9016. Perfiles laterales en metal cromado o niquel satinado. Las versiones con 4 lámparas están cableadas para doble encendido separado.

Version LED suministrada con led smd y alimentador electronico incluido.

Decken- oder Wandleuchte. Diffusor aus extra hellem satiniertem weißem Glas. Fassung aus weiß lackiertem Metall Ral 9016. Seitenprofile aus verchromtem Metall oder gebürstet Nickel farbigem Metall. Die Ausführungen mit 4 Lampen sind für das doppelte getrennte Einschalten verkabelt.

Ausführung LED zum led smd und integriert Versorgungsgerät elektronisch.

Vip 500 - Vip 501

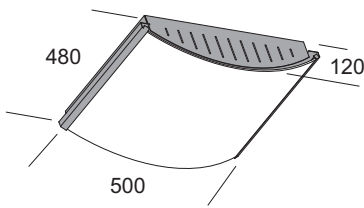

Articolo <i>Item</i>	Colore profili <i>Profiles color</i>		W _{max}		LUMEN		LUMEN/W		
	CR Codice	NS Code							
● Led vip 500 led-W	15681	15686	23	led	3120	IP20	⊕	136 C	
● Led DM vip 500 DM led-W	15701	15706	23	led	3120	IP20	⊕	136 C	
● Led EM vip 500 EM led-W	14841	14846	23	led	3120	IP20	⊕	136 C	
● Led vip 500 led-N	15691	15696	23	led	3120	IP20	⊕	136 C	
● Led DM vip 500 DM led-N	15711	15716	23	led	3120	IP20	⊕	136 C	
● Led EM vip 500 EM led-N	14851	14856	23	led	3120	IP20	⊕	136 C	
EL vip 500	19561	19566	2x36	2G11	5800	IP20	⊕	81 A	
EM vip 500 EM	10351	10356	2x36	2G11	5800	IP20	⊕	81 A	
● Led vip 501 led-W	15721	15726	46	led	6240	IP20	⊕	136 C	
● Led DM vip 501 DM led-W	15741	15746	46	led	6240	IP20	⊕	136 C	
● Led EM vip 501 EM led-W	14861	14866	46	led	6240	IP20	⊕	136 C	
● Led vip 501 led-N	15731	15736	46	led	6240	IP20	⊕	136 C	
● Led DM vip 501 DM led-N	15751	15756	46	led	6240	IP20	⊕	136 C	
● Led EM vip 501 EM led-N	14871	14876	46	led	6240	IP20	⊕	136 C	
EL vip 501	19571	19576	4x36	2G11	11600	IP20	⊕	81 B	
DM vip 501 DM	19781	19786	4x36	2G11	11600	IP20	⊕	81 B	

Colore profili *Profiles color*

● Nuova versione *New version*

CR Cromato *Chrome* **NS** Nickel spazzolato *Brushed nickel*

Led Equipaggiata con led 3000K - *Equipped with led 3000K*

Led Equipaggiata con led 4000K - *Equipped with led 4000K*

Led DM **Led DM** **DM** Dimmerabile PUSH/DALI
Dimmable PUSH/DALI (info page10)

Led EM **Led EM** **EM** Emergenza (SA) 1h di serie – 3h a richiesta
Emergency 1h standard – 3h on request

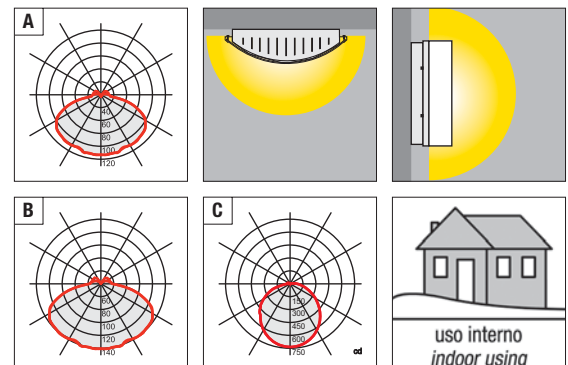



DuoDK - SplitDK

Lampada da soffitto. Diffusore, non orientabile, in alluminio purissimo 99,99% brillantato conforme alla normativa EN 12464. Struttura in alluminio estruso. Particolari in policarbonato trasparente. Le versioni con 4 lampade sono cablate per doppia accensione separata. Tutte le lampade hanno l'alimentatore elettronico incorporato. **Installabile in linea continua.**

Ceiling lamp. No-adjustable diffuser, realized in polished pure aluminium 99,99%, following rule EN12464. Structure made in extruded aluminium. Details made in transparent polycarbonate. Versions cabled with 4 bulbs are equipped with double separate lighting. All fittings have electronic driver included. **Suitable for continuous-row lighting.**

Lampe à plafond. Diffuseur, non orientable, en aluminium pur à 99,99% brillant conforme à la réglementation EN 12464. Structure réalisée en extrusion d'aluminium. Détails en polycarbonate transparent. Les versions câblées avec 4 ampoules sont équipées avec allumage double séparée. Toutes les versions sont avec ballast électronique incorporé. **Installable en ligne continue.**

Lámpara de techo. Difusor, no orientable, en aluminio purísimo 99,99% abrillantado en conformidad con la normativa EN 12464. Estructura de aluminio extrudido. Detalles de policarbonato transparente. Las versiones con 4 lámparas están cableadas para doble encendido separado. Todas las lámparas tienen alimentador electrónico incluido. **Instalable en línea continua.**

Deckenleuchte. Diffusor, nicht verstellbar, aus reinem polierten Aluminium 99,99%, gemäß EN 12464. Struktur aus Aluminium Extrusion. Einzelteile aus transparentem Polycarbonat. Die Ausführungen mit 4 Lampen sind für das doppelte getrennte Einschalten verkabelt. Alle Versionen mit integriertem Versorgungsgerät elektronisch. **Ausführung ist in Lichtbandversion.**

DuoDK AP 60

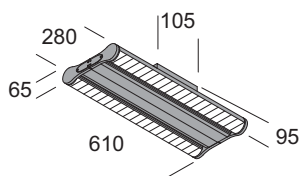

Colore struttura Structure color

Articolo Item	Colore struttura Structure color		W _{max}		LUMEN		LUMEN/W	
	CR	AL						
	Codice Code							
EL duoDK AP 60/2x24 EL	39388	39389	2x24	G5	4000	IP20	83	A
	39408	39409	4x24	G5	8000	IP20	83	A
DM duoDK AP 60/4x24 DM	39688	39689	4x24	G5	8000	IP20	83	A
EM duoDK AP 60/2x24 EM	30128	30129	2x24	G5	4000	IP20	83	A

DuoDK AP 90

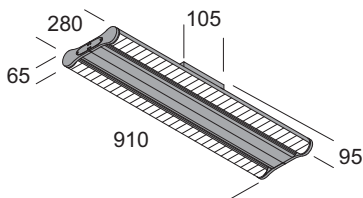

EL duoDK AP 90/2x39 EL	39398	39399	2x39	G5	7000	IP20	90	A
	39418	39419	4x39	G5	14000	IP20	90	A
DM duoDK AP 90/4x39 DM	39698	39699	4x39	G5	14000	IP20	90	A
EM duoDK AP 90/2x39 EM	30138	30139	2x39	G5	7000	IP20	90	A
	30218	30219	4x39	G5	14000	IP20	90	A

Colore struttura Structure color

CR Alluminio brillantato (effetto cromato) *Shined aluminium (chrome effect)*

AL Alluminio anodizzato *Oxided aluminium*

DM Dimmerabile PUSH/DALI
Dimmable PUSH/DALI (info page 10)

EM Emergenza (SA) 1h di serie – 3h a richiesta
Emergency 1h standard – 3h on request

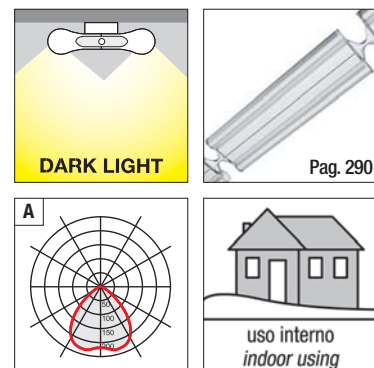

SplitDK 60

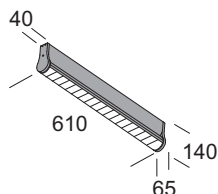

Articolo Item	Colore struttura Structure color		W _{max}		LUMEN		LUMEN/W	
	CR	AL						
	Codice Code							
EL splitDK 60/24 EL	39218	39219	1x24	G5	2000	IP20	83	A
	splitDK 60/2x24 EL	39258	39259	2x24	G5	4000	IP20	83
EM splitDK 60/24 EM	30028	30029	1x24	G5	2000	IP20	83	A
	splitDK 60/2x24 EM	30228	30229	2x24	G5	4000	IP20	83

SplitDK 90

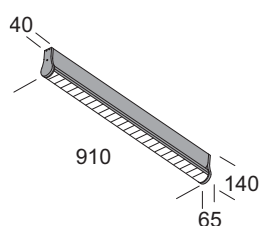

EL splitDK 90/39 EL	39228	39229	1x39	G5	3500	IP20	90	A
	splitDK 90/2x39 EL	39268	39269	2x39	G5	7000	IP20	90
DM splitDK 90/2x39 DM	39708	39709	2x39	G5	7000	IP20	90	A
EM splitDK 90/39 EM	30048	30049	1x39	G5	3500	IP20	90	A
	splitDK 90/2x39 EM	30238	30239	2x39	G5	7000	IP20	90

SplitDK 120

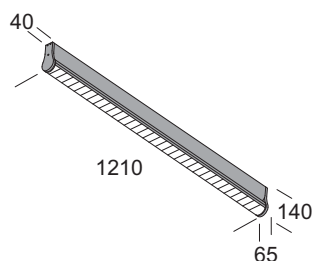

EL splitDK 120/54 EL	39238	39239	1x54	G5	5000	IP20	93	A
	splitDK 120/2x54 EL	39278	39279	2x54	G5	10000	IP20	93
DM splitDK 120/2x54 DM	39718	39719	2x54	G5	10000	IP20	93	A
EM splitDK 120/54 EM	30058	30059	1x54	G5	5000	IP20	93	A
	splitDK 120/2x54 EM	30248	30249	2x54	G5	10000	IP20	93

Colore struttura Structure color

CR

Alluminio brillantato (effetto cromato) Shined aluminium (chrome effect)

AL

Alluminio anodizzato Oxided aluminium

DM

Dimmerabile PUSH/DALI
Dimmable PUSH/DALI (info page 10)

EM

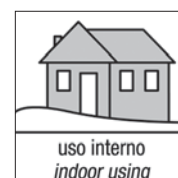
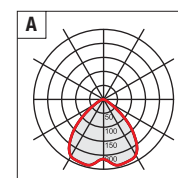
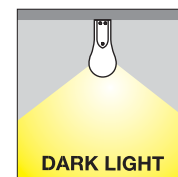
Emergenza (SA) 1h di serie – 3h a richiesta
Emergency 1h standard – 3h on request

SplitDK 150

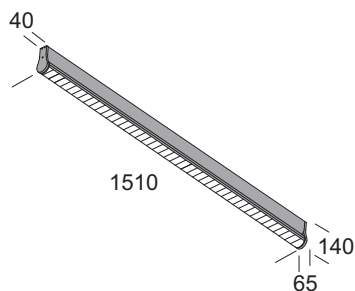

Articolo Item	Colore struttura Structure color		W _{max}	G5	LUMEN	IP20	LUMEN/W	A
	CR Codice	AL Code						
EL splitDK 150/80 EL	39248	39249	1x80	G5	7000	IP20	88	A
splitDK 150/2x80 EL	39288	39289	2x80	G5	14000	IP20	88	A
DM splitDK 150/2x80 DM	39728	39729	2x80	G5	14000	IP20	88	A
EM splitDK 150/80 EM	30068	30069	1x80	G5	7000	IP20	88	A
splitDK 150/2x80 EM	30258	30259	2x80	G5	14000	IP20	88	A



Colore struttura Structure color

CR
Alluminio brillantato (effetto cromato) *Shined aluminium (chrome effect)*

AL
Alluminio anodizzato *Oxided aluminium*

DM Dimmerabile PUSH/DALI
Dimmable PUSH/DALI (info page10)

EM Emergenza (SA) 1h di serie – 3h a richiesta
Emergency 1h standard – 3h on request

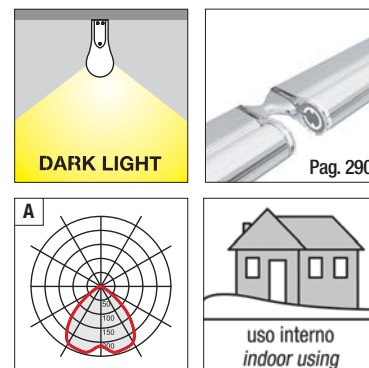





Flash P

Serie di lampade composta da faretto orientabili. Struttura in policarbonato trasparente con montatura in metallo bianco opaco ral 9016 o colore alluminio ral 9006. **Equipaggiata con led COB e alimentatore elettronico incorporato. Lente ad emissione stretta 25° o larga 40°.**

Range of light composed by adjustable spot. Structure made in transparent polycarbonate with matt white painted metal frame ral 9016 or aluminium painted metal frame ral 9006. **Equipped with COB led and electronic driver included. Emission lens with narrow-angle 25° or wide-angle 40°.**

Collection de lampes réalisé avec projecteurs réglables. Structure en polycarbonate transparent avec monture en métal verni blanc opaque ral 9016 ou en métal verni couleur aluminium ral 9006. **Equipée avec led COB et ballast électronique incorporé. Lentille pour lumière diffuse étroit 25° ou large 40°.**

Serie de lámparas compuestas por proyectores giratorios. Estructura en policarbonato transparente con montura de metal pintado blanco opaco ral 9016 o pintado color aluminio ral 9006. **Suministrada con led COB y alimentador electrónico incluido. Lente con haz estrecho de 25° o haz amplio de 40°.**

Eine Schwenkbare serie Spotlight. Struktur aus transparentem Polycarbonat mit Metall Frame weiß matt RAL 9016 oder RAL 9006 Aluminium Farbe. Rosette aus weiß lackiertem matt RAL 9016 oder Aluminium Farbe RAL 9006. **Ausgestattet mit LED-COB und elektronisches Vorschaltgerät. Objektiv emittierende engen 25 ° oder 40 ° breit**

Flash P

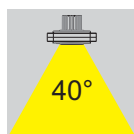
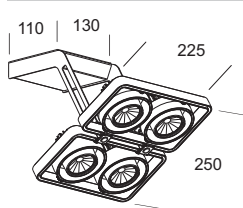

Articolo Item	Colore struttura Structure color		W _{max}	LUMEN	LUMEN/W	A
	AL	BI				
	Codice Code					
Led flash PS-W	24009	24001	28,4	led 3200 IP20	⊕	113 A
Led DM flash PS-W DM	24029	24021	28,4	led 3200 IP20	⊕	113 A
Led flash PS-N	24019	24011	28,4	led 3200 IP20	⊕	113 A
Led DM flash PS-N DM	24039	24031	28,4	led 3200 IP20	⊕	113 A
Led flash PL-W	24049	24041	28,4	led 3200 IP20	⊕	113 B
Led DM flash PL-W DM	24069	24061	28,4	led 3200 IP20	⊕	113 B
Led flash PL-N	24059	24051	28,4	led 3200 IP20	⊕	113 B
Led DM flash PL-N DM	24079	24071	28,4	led 3200 IP20	⊕	113 B

Colore struttura Structure color

AL RAL 9006 Alluminio Aluminium	BI RAL 9016 Bianco opaco Matt white
---	---

- Led** Equipaggiata con led 3000K - Equipped with led 3000K
- Led** Equipaggiata con led 4000K - Equipped with led 4000K
- Led DM** **Led DM** Dimmerabile PUSH/DALI
Dimmable PUSH/DALI (info page10)

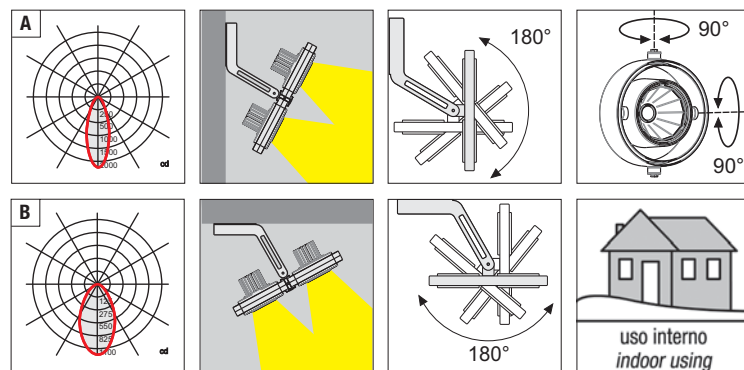



Flash I *Incasso-Recessed*









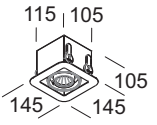

Flash è installabile nei controsoffitti.

Flash can be installed as recessed lamp in false-ceilings.

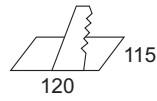
Flash est encastrable dans les plafond.

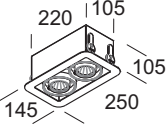
Flash se instala empotrada en el techo.

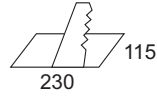
Flash kann installiert Einbau in der Decken.

Flash I1		Articolo <i>Item</i>	Colore cornice <i>Ring color</i>		W _{max}		LUMEN		LUMEN/W		
			AL	BI							
			Codice	Code							
 	Led	flash I1S-W	20139	20131	7,1	led	800	IP20	⊕	113	A
	Led DM	flash I1S-W DM	20159	20151	7,1	led	800	IP20	⊕	113	A
	Led	flash I1S-N	20149	20141	7,1	led	800	IP20	⊕	113	A
	Led DM	flash I1S-N DM	20169	20161	7,1	led	800	IP20	⊕	113	A
 	Led	flash I1L-W	20179	20171	7,1	led	800	IP20	⊕	113	B
	Led DM	flash I1L-W DM	20199	20191	7,1	led	800	IP20	⊕	113	B
	Led	flash I1L-N	20189	20181	7,1	led	800	IP20	⊕	113	B
	Led DM	flash I1L-N DM	20209	20201	7,1	led	800	IP20	⊕	113	B
Flash I2											
 	Led	flash I2S-W	20219	20211	14,2	led	1600	IP20	⊕	113	A
	Led DM	flash I2S-W DM	20239	20231	14,2	led	1600	IP20	⊕	113	A
	Led	flash I2S-N	20229	20221	14,2	led	1600	IP20	⊕	113	A
	Led DM	flash I2S-N DM	20249	20241	14,2	led	1600	IP20	⊕	113	A
 	Led	flash I2L-W	20259	20251	14,2	led	1600	IP20	⊕	113	B
	Led DM	flash I2L-W DM	20279	20271	14,2	led	1600	IP20	⊕	113	B
	Led	flash I2L-N	20269	20261	14,2	led	1600	IP20	⊕	113	B
	Led DM	flash I2L-N DM	20289	20281	14,2	led	1600	IP20	⊕	113	B

Colore cornice *Ring color*

AL **RAL 9006**
Alluminio *Aluminium*

BI **RAL 9016**
Bianco opaco *Matt white*

Led Equipaggiata con led 3000K - *Equipped with led 3000K*

Led Equipaggiata con led 4000K - *Equipped with led 4000K*

Led DM Led DM Dimmerabile PUSH/DALI
Dimmable PUSH/DALI (info page10)

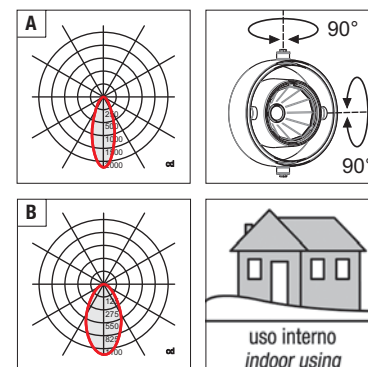

Flash I4

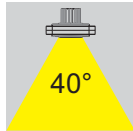
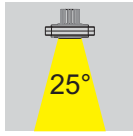
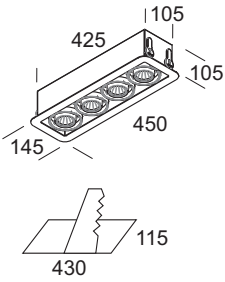

Colore cornice Ring color

AL BI
Codice Code

W_{max}



LUMEN



LUMEN/W



Articolo Item	AL	BI	W _{max}	led	LUMEN	IP20	LUMEN/W	A
Led flash I4S-W	20299	20291	28,4	led	3200	IP20	⊕ 113	A
Led DM flash I4S-W DM	20319	20311	28,4	led	3200	IP20	⊕ 113	A
Led flash I4S-N	20309	20301	28,4	led	3200	IP20	⊕ 113	A
Led DM flash I4S-N DM	20329	20321	28,4	led	3200	IP20	⊕ 113	A
Led flash I4L-W	20339	20331	28,4	led	3200	IP20	⊕ 113	B
Led DM flash I4L-W DM	20359	20351	28,4	led	3200	IP20	⊕ 113	B
Led flash I4L-N	20349	20341	28,4	led	3200	IP20	⊕ 113	B
Led DM flash I4L-N DM	20369	20361	28,4	led	3200	IP20	⊕ 113	B

Flash IQ

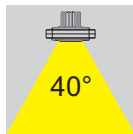
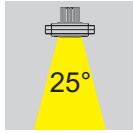
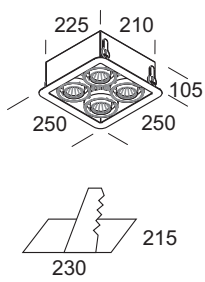

Led flash IQS-W	20379	20371	28,4	led	3200	IP20	⊕ 113	A
Led DM flash IQS-W DM	20399	20391	28,4	led	3200	IP20	⊕ 113	A
Led flash IQS-N	20389	20381	28,4	led	3200	IP20	⊕ 113	A
Led DM flash IQS-N DM	20409	20401	28,4	led	3200	IP20	⊕ 113	A
Led flash IQL-W	20419	20411	28,4	led	3200	IP20	⊕ 113	B
Led DM flash IQL-W DM	20439	20431	28,4	led	3200	IP20	⊕ 113	B
Led flash IQL-N	20429	20421	28,4	led	3200	IP20	⊕ 113	B
Led DM flash IQL-N DM	20449	20441	28,4	led	3200	IP20	⊕ 113	B

Colore cornice Ring color

AL RAL 9006
Alluminio Aluminium

BI RAL 9016
Bianco opaco Matt white

Led Equipaggiata con led 3000K - Equipped with led 3000K

Led Equipaggiata con led 4000K - Equipped with led 4000K

Led DM Led DM Dimmerabile PUSH/DALI
Dimmable PUSH/DALI (info page10)

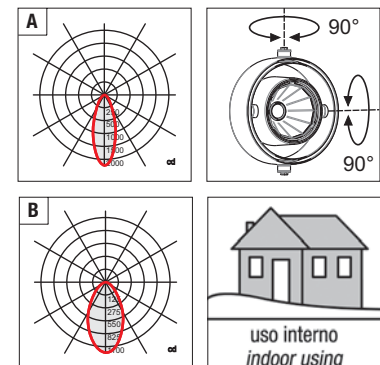

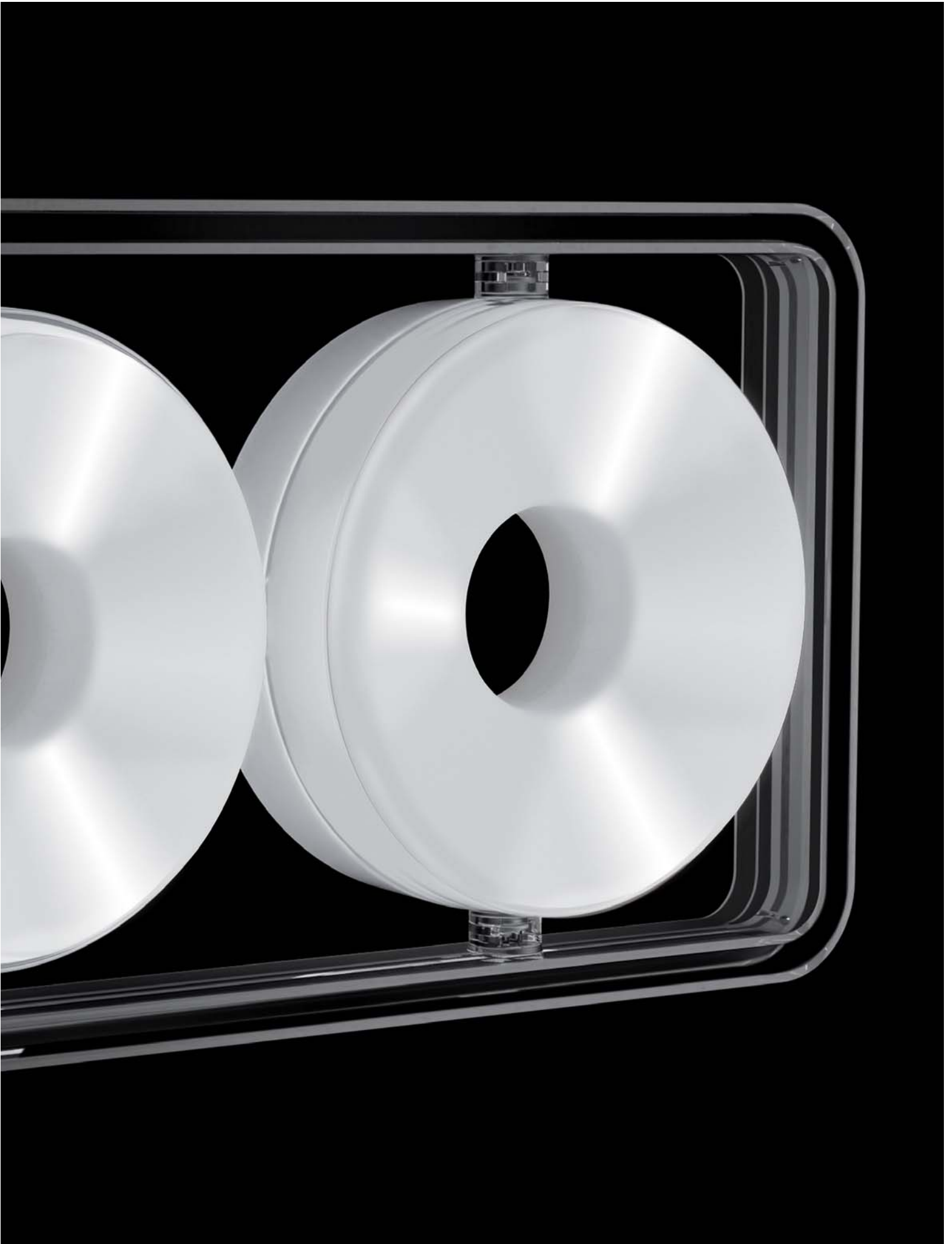



Vog P

Serie di lampade composta da faretto orientabili. Struttura in policarbonato trasparente con montatura in metallo bianco opaco ral 9016 o colore alluminio ral 9006. Diffusori in policarbonato opale. **Equipaggiata con led smd e alimentatore elettronico incorporato.**

Range of light composed by adjustable spot. Structure made in transparent polycarbonate with matt white painted metal frame ral 9016 or aluminium painted metal frame ral 9006. Diffusers made in opal polycarbonate. **Equipped with smd led and electronic driver included.**

Collection de lampes réalisé avec projecteurs réglables. Structure en polycarbonate transparent avec monture en métal verni blanc opaque ral 9016 ou en métal verni couleur aluminium ral 9006. Diffuseurs en polycarbonate opale. **Equipée avec led smd et ballast électronique incorporé.**

Serie de lámparas compuestas por proyectores giratorios. Estructura en policarbonato transparente con montura de metal pintado blanco opaco ral 9016 o pintado color aluminio ral 9006. Difusores de policarbonato opale. **Suministrada con led smd y alimentador electronico incluido.**

Eine Schwenkbare serie Spotlight. Struktur aus transparentem Polycarbonat mit Metall Frame weiß matt RAL 9016 oder RAL 9006 Aluminium Farbe. Rosette aus weiß lackiertem matt RAL 9016 oder Aluminium Farbe RAL 9006. Diffusoren in opal Polycarbonat. **Ausgestattet mit SMD-LEDs und elektronisches Vorschaltgerät.**

Vog P

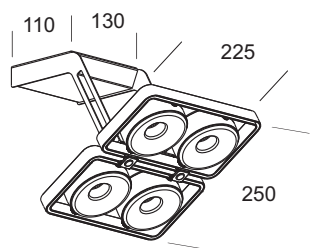

Colore struttura Structure color

Articolo Item

AL BI

W_{max}



LUMEN



LUMEN/W



Codice Code

Articolo Item	AL	BI	W _{max}	Light distribution	LUMEN	Water drop	LUMEN/W	Energy efficiency
Led vog P-W	15989	15981	24	led	3080	IP20	⊕ 128	A
Led vog P-N	15999	15991	24	led	3080	IP20	⊕ 128	A

Colore struttura Structure color

AL RAL 9006

Alluminio Aluminium

BI RAL 9016

Bianco opaco Matt white

Led Equipaggiata con led 3000K - Equipped with led 3000K

Led Equipaggiata con led 4000K - Equipped with led 4000K

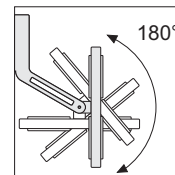
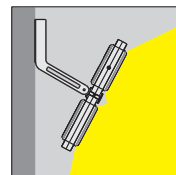
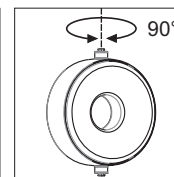
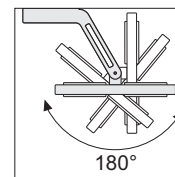
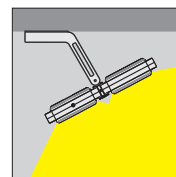
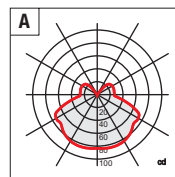

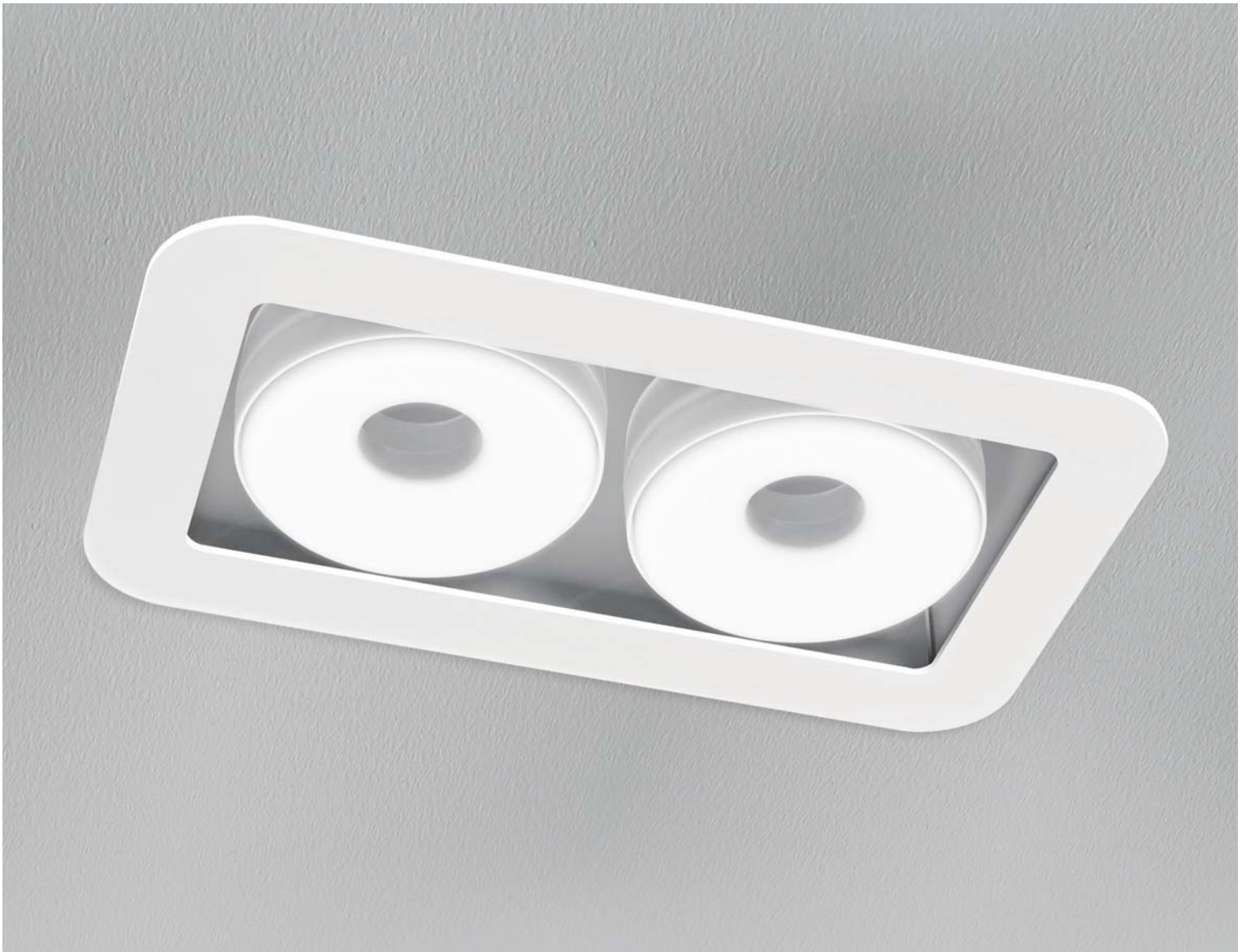

Vog I *Incasso-Recessed*

Vog è installabile nei controsoffitti.

Vog can be installed as recessed lamp in false-ceilings.

Vog est encastrable dans les plafond.

Vog se installa empotrada en el techo.

Vog kann installiert Einbau in der Decken.

Vog I1	Articolo Item	Colore cornice Ring color		W _{max}		LUMEN		LUMEN/W	
		AL	BI						
		Codice Code							
	Led vog I1-W	20459	20451	6	led	770	IP20	⊕	128 A
	Led vog I1-N	20469	20461	6	led	770	IP20	⊕	128 A

Vog I2	Articolo Item	Colore cornice Ring color		W _{max}		LUMEN		LUMEN/W	
		AL	BI						
		Codice Code							
	Led vog I2-W	20479	20471	12	led	1540	IP20	⊕	128 A
	Led vog I2-N	20489	20481	12	led	1540	IP20	⊕	128 A

Colore cornice Ring color

AL RAL 9006 Alluminio Aluminium
BI RAL 9016 Bianco opaco Matt white

- Led** Equipaggiata con led 3000K - Equipped with led 3000K
- Led** Equipaggiata con led 4000K - Equipped with led 4000K

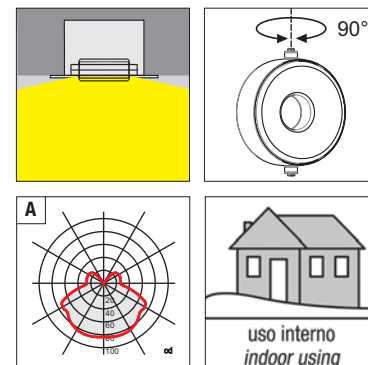

Vog I4

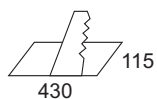
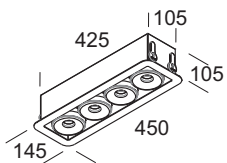

Colore cornice Ring color

Articolo Item

AL BI

W_{max}



LUMEN



LUMEN/W



Codice Code

Led	vog I4-W	20499	20491	24	led	3080	IP20	⊕	128	A
Led	vog I4-N	20509	20501	24	led	3080	IP20	⊕	128	A

Vog IQ

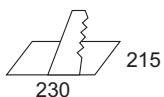
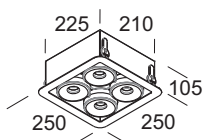

Led	vog IQ-W	20519	20511	24	led	3080	IP20	⊕	128	A
Led	vog IQ-N	20529	20521	24	led	3080	IP20	⊕	128	A

Colore cornice Ring color

AL RAL 9006
Alluminio Aluminium

BI RAL 9016
Bianco opaco Matt white

Led Equipaggiata con led 3000K - Equipped with led 3000K

Led Equipaggiata con led 4000K - Equipped with led 4000K

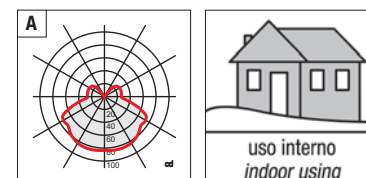
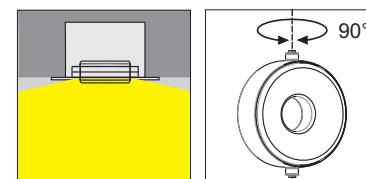

Top Plus

Lampada da soffitto o parete. La base trasparente o colorata permette di creare, sulla parete, un alone colorato mantenendo il flusso di luce centrale bianco. Diffusore in vetro pressato, prismatico e sabbiato internamente. Base in policarbonato autoestinguente. Anello in tecnopolimero colorato alluminio ral 9006. **Versione LED equipaggiata con led smd e alimentatore elettronico incorporato.**

Ceiling or wall lamp. The transparent or coloured base permits to create, on the wall, a coloured ring leaving the central light in white. Diffuser made in pressed glass prismatic and sandblasted inside. Base made in polycarbonate auto-extinguishing. Ring made in techno-polymer aluminium coloured ral 9006. **LED version equipped with smd led and electronic driver included.**

Lampe à plafond ou à mur. La base transparente ou colorée permet de créer, sur le mur, un halo coloré conservant la lumière centrale blanche. Diffuseur réalisé en verre pressé, prismatique et sablé à l'intérieur. Base réalisée en polycarbonate auto extinguable. Anneau en tecno-polymère couleur aluminium ral 9006. **Version LED équipée avec led smd et ballast électronique incorporé.**

Lámpara de techo o pared. La base transparente o de colores permite crear, en la pared, un halo de colores manteniendo el flujo de luz central blanco. Difusor de vidrio presado, prismático y arenado internamente. Base en policarbonato de autoextinción. Anillo de tecnopolímero de colores aluminio ral 9006. **Version LED suministrada con led smd y alimentador electrónico incluido.**

Decken-oder Wandleuchte. Die transparente oder farbige Basis ermöglicht es, an der Wand einen farbigen Lichthof zu erzeugen, wobei der zentrale Lichtfluss weiß bleibt. Diffusor aus Pressglas, innen prismatisch und sandgestrahlt. Basis aus selbstlöschendem Polycarbonat. Ring aus alufarbenem RAL 9006 Technopolymer. **Ausführung LED zum led smd und integriert Versorgungsgerät elektronisch.**



Top Plus

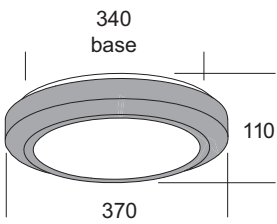

Articolo Item	Colore base Frame color				W _{max}	E27	LUMEN	IP65	LUMEN/W	A
	BL	GI	RO	TR						
	Codice Code									
E27 top plus	13455	13452	13453	13451	1x77	E27	1320	IP65	17	A
● Led top plus led-W	16785	16782	16783	16781	15,3	led	2070	IP65	135	C
● Led DM top plus DM led-W	15585	15582	15583	15581	15,3	led	2070	IP65	135	C
● Led EM top plus EM led-W	14725	14722	14723	14721	15,3	led	2070	IP65	135	C
● Led top plus led-N	16795	16792	16793	16791	15,3	led	2070	IP65	135	C
● Led DM top plus DM led-N	15595	15592	15593	15591	15,3	led	2070	IP65	135	C
● Led EM top plus EM led-N	14735	14732	14733	14731	15,3	led	2070	IP65	135	C
EL top plus EL	19285	19282	19283	19281	1x26	G24q-3	1800	IP65	69	A
top plus EL/52	18775	18772	18773	18771	2x26	G24q-3	3600	IP65	69	B
EM top plus EM	10265	10262	10263	10261	1x26	G24q-3	1800	IP65	69	A

Colore base Frame color

● Nuova versione New version

BL RAL 5017 Blu Blue	GI RAL 1023 Giallo Yellow	RO RAL 3000 Rosso Red	TR Trasparente Transparent
--------------------------------	-------------------------------------	---------------------------------	--------------------------------------

Led Equipaggiata con led 3000K - Equipped with led 3000K

Led Equipaggiata con led 4000K - Equipped with led 4000K

Led DM **Led DM** Dimmerabile PUSH/DALI
Dimmable PUSH/DALI (info page10)

Led EM **Led EM** **EM** Emergenza (SA) 1h di serie – 3h a richiesta
Emergency 1h standard – 3h on request

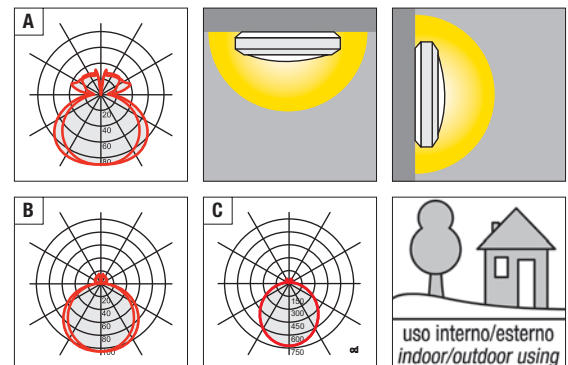



Top Extra

Lampada da soffitto o parete. La base trasparente o colorata permette di creare, sulla parete, un alone colorato mantenendo il flusso di luce centrale bianco. **Diffusore in policarbonato** colore anice, prismato internamente. Base in policarbonato autoestinguento. Anello in tecnopolimero colorato bianco goffrato ral 9016, grigio goffrato ral 9006 o antracite goffrato ral 7016. **Versione LED equipaggiata con led smd e alimentatore elettronico incorporato**

Ceiling or wall lamp. The transparent or coloured base permit to create, on the wall, a coloured ring leaving the central light in white. **Diffuser made in polycarbonate** colour anise prismatic inside. Base made in polycarbonate auto-extinguishing. Ring made in techno-polymer embossed white ral 9016, embossed grey ral 9006 or embossed anthracite ral 7016 painted. **LED version equipped with smd led and electronic driver included.**

Lampe à plafond ou à mur. La base transparente ou colorée permet de créer, sur le mur, un halo coloré conservant la lumière centrale blanche. **Diffuseur en polycarbonate** couleur anis, prismatique à l'intérieur. Base réalisée en polycarbonate auto-extinguible. Anneau en techno-polymère verni blanc gaufré ral 9016, gris gaufré ral 9006 ou anthracite gaufré ral 7016. **Version LED équipée avec led smd et ballast électronique incorporé.**

Lámpara de techo o pared. La base transparente o de colores permite crear, en la pared, un halo de colores manteniendo el flujo de luz central blanco. **Diffusor de policarbonato** de color anís, prismático internamente. Base de policarbonato de autoextinción. Anillo de tecnopolímero de colores blanco rugoso ral 9016, gris rugoso ral 9006 o antracita rugoso ral 7016. **Version LED suministrada con led smd y alimentador electrónico incluido.**

Decken- oder Wandleuchte. Die transparente oder farbige Basis ermöglicht es, an der Wand einen farbigen Lichthof zu erzeugen, während der zentrale Lichtfluss weiß bleibt. **Diffusor aus anisfarbenem Polycarbonat**, innen prismatisch. Basis aus selbstlöschendem Polycarbonat. Ring aus Technopolymer, Farbe weiß strukturiert Ral 9016, grau strukturiert Ral 9006 oder anthrazit strukturiert Ral 7016. **Ausführung LED zum led smd und integriert Versorgungsgerät elektronisch.**

Top Extra bianco

Colore fascia Ring color

BI RAL 9016
Bianco gofrato Embossed white

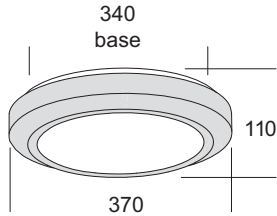

Articolo Item	Colore base Frame color				W _{max}	E27	LUMEN	IP65	LUMEN/W	A/C
	BL	GI	RO	TR						
E27 top extra	41495	41492	41493	41491	1x77	E27	1320	IP65	17	A
Led top extra led-W	46105	46102	46103	46101	15,3	led	2070	IP65	135	C
Led DM top extra DM led-W	46125	46122	46123	46121	15,3	led	2070	IP65	135	C
Led EM top extra EM led-W	40085	40082	40083	40081	15,3	led	2070	IP65	135	C
Led top extra led-N	46115	46112	46113	46111	15,3	led	2070	IP65	135	C
Led DM top extra DM led-N	46135	46132	46133	46131	15,3	led	2070	IP65	135	C
Led EM top extra EM led-N	40095	40092	40093	40091	15,3	led	2070	IP65	135	C
EL top extra EL	48455	48452	48453	48451	1x26	G24q-3	1800	IP65	69	A
top extra EL/52	48465	48462	48463	48461	2x26	G24q-3	3600	IP65	69	B
EM top extra EM	40045	40042	40043	40041	1x26	G24q-3	1800	IP65	69	A

Top Extra grigio

Colore fascia Ring color

GR RAL 9006
Grigio gofrato Embossed grey

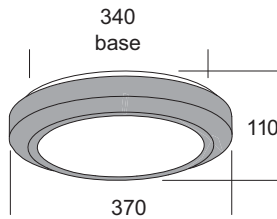

E27 top extra	41465	41462	41463	41461	1x77	E27	1320	IP65	17	A
Led top extra led-W	46145	46142	46143	46141	15,3	led	2070	IP65	135	C
Led DM top extra DM led-W	46165	46162	46163	46161	15,3	led	2070	IP65	135	C
Led EM top extra EM led-W	40105	40102	40103	40101	15,3	led	2070	IP65	135	C
Led top extra led-N	46155	46152	46153	46151	15,3	led	2070	IP65	135	C
Led DM top extra DM led-N	46175	46172	46173	46171	15,3	led	2070	IP65	135	C
Led EM top extra EM led-N	40115	40112	40113	40111	15,3	led	2070	IP65	135	C
EL top extra EL	48355	48352	48353	48351	1x26	G24q-3	1800	IP65	69	A
top extra EL/52	48015	48012	48013	48011	2x26	G24q-3	3600	IP65	69	B
EM top extra EM	40015	40012	40013	40011	1x26	G24q-3	1800	IP65	69	A

Colore base Frame color

● Nuova versione New version

BL RAL 5017 Blu Blue **GI RAL 1023** Giallo Yellow **RO RAL 3000** Rosso Red **TR** Trasparente Transparent

Led Equipaggiata con led 3000K - Equipped with led 3000K

Led Equipaggiata con led 4000K - Equipped with led 4000K

Led DM Dimmerabile PUSH/DALI
Dimmable PUSH/DALI (info page10)

Led EM Emergenza (SA) 1h di serie - 3h a richiesta
Emergency 1h standard - 3h on request

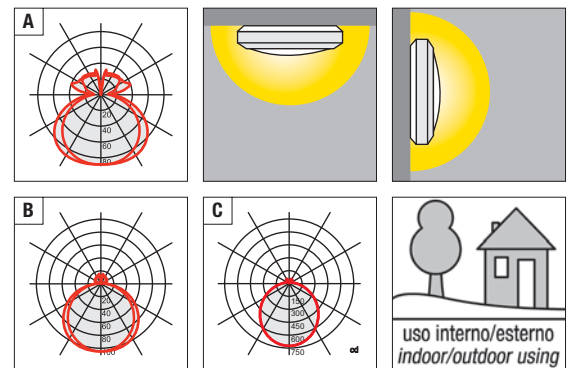

Top Extra antracite

Colore fascia Ring color

AT RAL 7016

Antracite gofrato Embossed anthracite

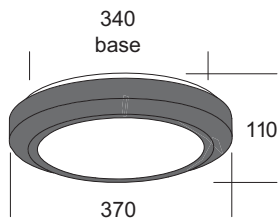

Articolo Item

Colore base Frame color

BL **GI** **RO** **TR**

W_{max}



LUMEN



LUMEN/W



Codice Code

Articolo Item	BL	GI	RO	TR	W _{max}	LUMEN	LUMEN/W	Icon	Icon	Icon
E27 top extra	41455	41452	41453	41451	1x77	E27	1320	IP65	□	17 A
Led top extra led-W	46065	46062	46063	46061	15,3	led	2070	IP65	⊕	135 C
Led DM top extra DM led-W	46085	46082	46083	46081	15,3	led	2070	IP65	⊕	135 C
Led EM top extra EM led-W	40065	40062	40063	40061	15,3	led	2070	IP65	⊕	135 C
Led top extra led-N	46075	46072	46073	46071	15,3	led	2070	IP65	⊕	135 C
Led DM top extra DM led-N	46095	46092	46093	46091	15,3	led	2070	IP65	⊕	135 C
Led EM top extra EM led-N	40075	40072	40073	40071	15,3	led	2070	IP65	⊕	135 C
EL top extra EL	48345	48342	48343	48341	1x26	G24q-3	1800	IP65	□	69 A
top extra EL/52	48005	48002	48003	48001	2x26	G24q-3	3600	IP65	⊕	69 B
EM top extra EM	40005	40002	40003	40001	1x26	G24q-3	1800	IP65	⊕	69 A

Colore base Frame color

● Nuova versione New version

BL RAL 5017
Blu Blue

GI RAL 1023
Giallo Yellow

RO RAL 3000
Rosso Red

TR
Trasparente Transparent

Led Equipaggiata con led 3000K - Equipped with led 3000K

Led Equipaggiata con led 4000K - Equipped with led 4000K

Led DM **Led DM** Dimmerabile PUSH/DALI
Dimmable PUSH/DALI (info page10)

Led EM **Led EM** **EM** Emergenza (SA) 1h di serie – 3h a richiesta
Emergency 1h standard – 3h on request

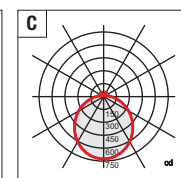
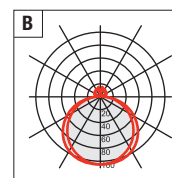
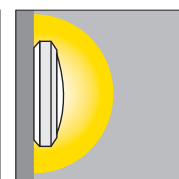
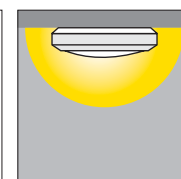
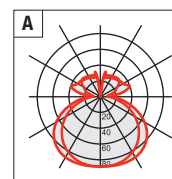

Top Extra ruggine

Colore fascia Ring color

RU
Ruggine Rust

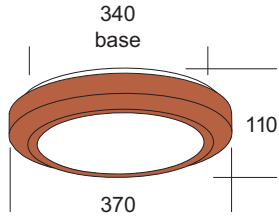

Articolo Item	Colore base Frame color		W _{max}	LUMEN	LUMEN/W	A
	TR	Codice Code				
● E27 top extra		41511	1x77	E27 1320 IP65	17	A
● Led top extra led-W		46181	15,3	led 2070 IP65	135	C
● Led DM top extra DM led-W		46201	15,3	led 2070 IP65	135	C
● Led EM top extra EM led-W		40131	15,3	led 2070 IP65	135	C
● Led top extra led-N		46191	15,3	led 2070 IP65	135	C
● Led DM top extra DM led-N		46211	15,3	led 2070 IP65	135	C
● Led EM top extra EM led-N		40141	15,3	led 2070 IP65	135	C
● EL top extra EL		48501	1x26	G24q-3 1800 IP65	69	A
● top extra EL/52		48511	2x26	G24q-3 3600 IP65	69	B
● EM top extra EM		40121	1x26	G24q-3 1800 IP65	69	A

Colore base Frame color

● Nuova versione New version

TR
Trasparente Transparent

Led Equipaggiata con led 3000K - Equipped with led 3000K

Led Equipaggiata con led 4000K - Equipped with led 4000K

Led DM **Led DM** Dimmerabile PUSH/DALI
Dimmable PUSH/DALI (info page 10)

Led EM **Led EM** **EM** Emergenza (SA) 1h di serie – 3h a richiesta
Emergency 1h standard – 3h on request

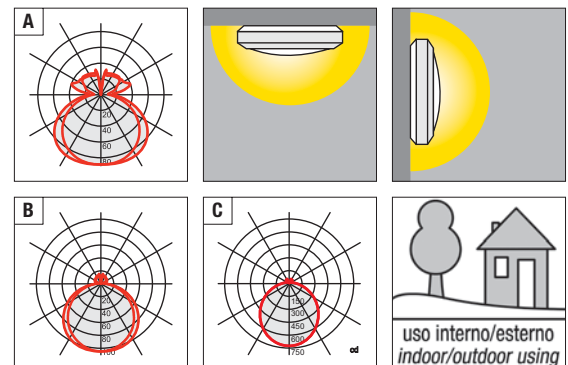

Astra

Lampada da soffitto o parete. Diffusore in vetro soffiato opale triplex satinato con sistema di aggancio a baionetta. La base trasparente o colorata, in policarbonato autoestinguente, permette di creare, sulla parete, un alone colorato mantenendo il flusso di luce centrale bianco. Base KOMBI in metallo verniciato bianco ral 9016. Guarnizione in silicone per le versioni IP54 e IP65. **Versione LED equipaggiata con led smd e alimentatore elettronico incorporato. Versioni LED24 per installazione in zona 1 (in prossimità di vasche o docce CEI 64-8/7 art.701.32) funzionanti con alimentatore remoto 24V non incluso e acquistabile separatamente.**

Ceiling or wall lamp. Diffuser made in blown satin opal triplex glass with bayonet lock system. The transparent or coloured base, made in auto-extinguishing polycarbonate, permits to create, on the wall, a coloured ring leaving the central light in white. Base KOMBI made in white painted metal ral 9016. Silicon gasket for versions IP54 and IP65. **LED version equipped with smd led and electronic driver included. LED24 versions suitable for installation in zone 1 (near a bathtub or shower CEI 64-8/7 art.701.32) working with 24V remote ballast not included and purchasable separately.**

Lampe à plafond ou à mur. Diffuseur en verre soufflé opale triplex satiné avec système d'accroche à baïonnette. La base transparente ou colorée, réalisée en polycarbonate auto-extinguible, permet de créer, sur le mur, un halo coloré conservant la lumière centrale blanche. Base KOMBI réalisée en métal vernie blanc ral 9016. Joint en silicone pour les versions IP54 et IP65. **Versión LED equipada con led smd et ballast electrónico incorporé. Versiones LED24 para instalación in zona 1 (près d'une baignoire ou d'une douche CEI 64-8/7 art.701.32) fonctionnant avec ballast 24V à distance pas inclus et vendu séparément.**

Lámpara de techo o pared. Difusor de vidrio soplado opal triplex satinado con sistema de enganche a bayoneta. La base transparente o de colores, en policarbonato de autoextinción, permite crear, en la pared, un halo de colores manteniendo el flujo de luz central blanco. Base KOMBI en metal pintado blanco ral 9016. Junta de protección de silicona para las versiones IP54 y IP65. **Versión LED suministrada con led smd y alimentador electrónico incluido. Versiones LED24 para el uso en zona 1 (en las proximidades de las duchas o bañera CEI 64-8/7 art.701.32) usando alimentador 24V a distancia no incluido y que se vende separado.**

Decken- oder Wandleuchte. Diffusor aus geblasenem Triplex-Opalglas, satiniert, mit Bajonettsystem zur Befestigung. Die transparente oder farbige Basis, aus selbstlöschendem Polycarbonat, ermöglicht es, an der Wand einen farbigen Lichthof zu erzeugen, wobei der zentrale Lichtfluss weiß bleibt. Basis KOMBI aus weiß lackiertem Metall Ral 9016. Silikondichtung für die Ausführungen IP54 und IP65. **Ausführung LED zum led smd und integriert Versorgungsgerät elektronisch. LED24 Versionen für den Einsatz in Zone 1 (Nähe Badewanne oder Duschen CEI 64-8/7 art.701.32) mit 24V Fernspeisung nicht inbegriffen und separat erhältlich.**





14 applique interni/esterni
wall lights indoor/outdoor

150 plafoniere interni/esterni
ceiling bowls indoor/outdoor

248 testaletto
bed head units

258 sospensioni
suspensions

344 lampade
lamps

384 lampioni ed incassi
bollards & recessed lights

450 indice
index

Astra 250

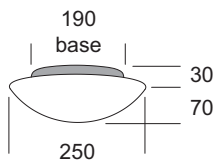

Articolo Item

Colore base Frame color

BL GI RO TR

Codice Code

W_{max}



LUMEN



LUMEN/W



Articolo Item	BL	GI	RO	TR	W _{max}	LUMEN	LUMEN/W	Icon	Icon		
E27 astra 250 IP	23035	23032	23033	23030	1x46	E27	700	IP65	□	15	A
● Led astra 250 led-W	16905	16902	16903	16900	8,33	led	1090	IP65	⊕	131	D
● Led 24 astra 250 led24-W	16925	16922	16923	16920	8,33	led 24V	1090	IP65	⊕	131	D
● Led DM astra 250 DM led-W	16945	16942	16943	16940	8,33	led	1090	IP65	⊕	131	D
● Led astra 250 led-N	16915	16912	16913	16910	8,33	led	1090	IP65	⊕	131	D
● Led 24 astra 250 led24-N	16935	16932	16933	16930	8,33	led 24V	1090	IP65	⊕	131	D
● Led DM astra 250 DM led-N	16955	16952	16953	16950	8,33	led	1090	IP65	⊕	131	D

Astra 300

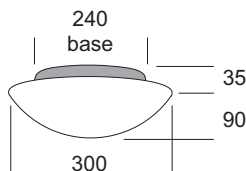

E27 astra 300 IP	23045	23042	23043	23040	1x77	E27	1320	IP65	□	17	A
● Led astra 300 led-W	16965	16962	16963	16960	10,5	led	1325	IP65	⊕	126	D
● Led 24 astra 300 led24-W	16985	16982	16983	16980	10,5	led 24V	1325	IP65	⊕	126	D
● Led DM astra 300 DM led-W	17005	17002	17003	17000	10,5	led	1325	IP65	⊕	126	D
● Led EM astra 300 EM led-W	14205	14202	14203	14200	10,5	led	1325	IP65	⊕	126	D
● Led astra 300 led-N	16975	16972	16973	16970	10,5	led	1325	IP65	⊕	126	D
● Led 24 astra 300 led24-N	16995	16992	16993	16990	10,5	led 24V	1325	IP65	⊕	126	D
● Led DM astra 300 DM led-N	17015	17012	17013	17010	10,5	led	1325	IP65	⊕	126	D
● Led EM astra 300 EM led-N	14215	14212	14213	14210	10,5	led	1325	IP65	⊕	126	D
EL astra 300 EL IP	28225	28222	28223	28220	1x26	G24q-3	1800	IP65	⊕	69	B
DM astra 300 DM IP	28015	28012	28013	28010	1x26	G24q-3	1800	IP65	⊕	69	B
EM astra 300 EM IP	10445	10442	10443	10440	1x18	G24q-2	1200	IP65	⊕	67	B
BI	Montatura in metallo verniciato bianco. Solo per installazione interna White painted metal frame. Only for indoor installation										
EM astra 300 EM/26	10451	KOMBI Ø270xH60			1x26	G24q-3	1800	IP20	⊕	69	B

Colore base Frame color

● Nuova versione New version

BL RAL 5017
Blu Blue

GI RAL 1023
Giallo Yellow

RO RAL 3000
Rosso Red

TR
Trasparente Transparent

BI RAL 9016
Bianco White

● Led Equipaggiata con led 3000K - Equipped with led 3000K

● Led Equipaggiata con led 4000K - Equipped with led 4000K

● Led 24 Installazione in zona 1 (in prossimità di vasche o docce CEI 64-8/7 art.701.32) con alimentatore remoto 24V non incluso e acquistabile separatamente (info pag. 9)
● Led 24 Installation in zone 1 (near a bathtub or shower CEI 64-8/7 art.701.32) with 24V remote ballast not included and purchasable separately (info page 9)

● Led DM Led DM DM Dimmerabile PUSH/DALI
Dimmable PUSH/DALI (info page 10)

● Led EM Led EM EM Emergenza (SA) 1h di serie - 3h a richiesta
Emergency 1h standard - 3h on request

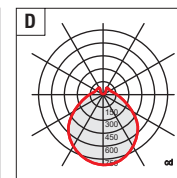
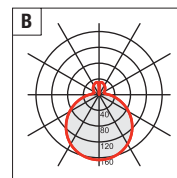
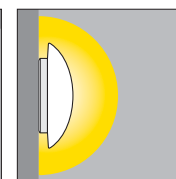
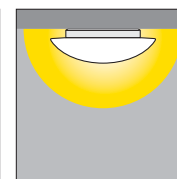
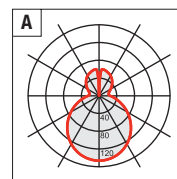

Famiglia prodotto
Product family

Plafoniere Ceiling bowls
Pag. 196-200

Astra 360

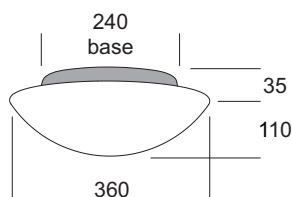

Articolo Item	Colore base Frame color				W _{max}	E27	LUMEN	IP	LUMEN/W	C
	BL	GI	RO	TR						
	Codice Code									
E27 astra 360 IP	23055	23052	23053	23050	2x46	E27	1400	IP65	15	C
● Led astra 360 led-W	17025	17022	17023	17020	15,5	led	1860	IP65	120	D
● Led 24 astra 360 led24-W	17045	17042	17043	17040	15,5	led 24V	1860	IP65	120	D
● Led DM astra 360 DM led-W	17065	17062	17063	17060	15,5	led	1860	IP65	120	D
● Led EM astra 360 EM led-W	14225	14222	14223	14220	15,5	led	1860	IP65	120	D
● Led astra 360 led-N	17035	17032	17033	17030	15,5	led	1860	IP65	120	D
● Led 24 astra 360 led24-N	17055	17052	17053	17050	15,5	led 24V	1860	IP65	120	D
● Led DM astra 360 DM led-N	17075	17072	17073	17070	15,5	led	1860	IP65	120	D
● Led EM astra 360 EM led-N	14235	14232	14233	14230	15,5	led	1860	IP65	120	D
EL astra 360 EL IP	28235	28232	28233	28230	2x18	G24q-2	2400	IP65	67	B
DM astra 360 DM IP	28055	28052	28053	28050	2x18	G24q-2	2400	IP65	67	B
EM astra 360 EM IP	10465	10462	10463	10460	1x26	G24q-3	1800	IP65	69	B
BI	Montatura in metallo verniciato bianco. Solo per installazione interna White painted metal frame. Only for indoor installation									
EM astra 360 EM/36	10471	KOMBI Ø270xH60			2x18	G24q-2	2400	IP20	67	B

Colore base Frame color

● Nuova versione New version

BL RAL 5017 Blu Blue	GI RAL 1023 Giallo Yellow	RO RAL 3000 Rosso Red	TR Trasparente Transparent	BI RAL 9016 Bianco White
--------------------------------	-------------------------------------	---------------------------------	--------------------------------------	------------------------------------

Led Equipaggiata con led 3000K - Equipped with led 3000K

Led Equipaggiata con led 4000K - Equipped with led 4000K

Led 24 Installazione in zona 1 (in prossimità di vasche o docce CEI 64-8/7 art.701.32) con alimentatore remoto 24V non incluso e acquistabile separatamente (info pag. 9)
Led 24 Installation in zone 1 (near a bathtub or shower CEI 64-8/7 art.701.32) with 24V remote ballast not included and purchasable separately (info page 9)

Led DM **Led DM** **DM** Dimmerabile PUSH/DALI
Dimmable PUSH/DALI (info page10)

Led EM **Led EM** **EM** Emergenza (SA) 1h di serie – 3h a richiesta
Emergency 1h standard – 3h on request

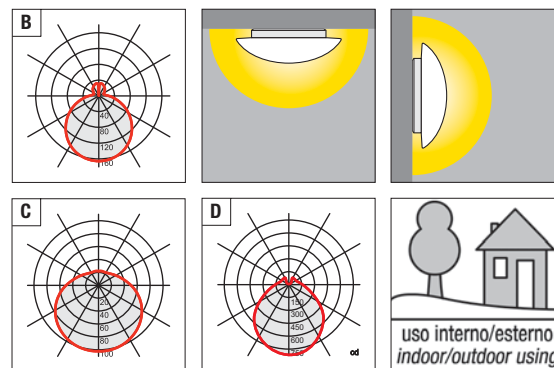

Astra 450

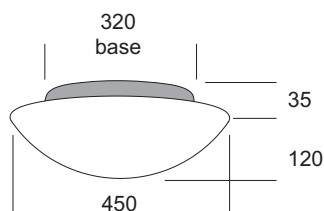

Articolo Item	Colore base Frame color				W _{max}	E27	LUMEN	IP	LUMEN/W	C					
	BL	GI	RO	TR											
	Codice Code														
E27 astra 450 IP					23065	23062	23063	23060	2x57	E27	1830	IP54	⊕	16	C
● Led astra 450 led-W					17085	17082	17083	17080	23,2	led	2680	IP54	⊕	116	D
● Led DM astra 450 DM led-W					17105	17102	17103	17100	23,2	led	2680	IP54	⊕	116	D
● Led EM astra 450 EM led-W					14245	14242	14243	14240	23,2	led	2680	IP54	⊕	116	D
● Led astra 450 led-N					17095	17092	17093	17090	23,2	led	2680	IP54	⊕	116	D
● Led DM astra 450 DM led-N					17115	17112	17113	17110	23,2	led	2680	IP54	⊕	116	D
● Led EM astra 450 EM led-N					14255	14252	14253	14250	23,2	led	2680	IP54	⊕	116	D
EL astra 450 EL IP					28245	28242	28243	28240	2x26	G24q-3	3600	IP54	⊕	69	B
DM astra 450 DM IP					28095	28092	28093	28090	2x26	G24q-3	3600	IP54	⊕	69	B
EM astra 450 EM IP					10485	10482	10483	10480	2x26	G24q-3	3600	IP54	⊕	69	B
BI	Montatura in metallo verniciato bianco. Solo per installazione interna White painted metal frame. Only for indoor installation														
EL astra 450 EL/64					19041	KOMBI Ø370xH65			2x32(a)	GX24q-3	4800	IP20	⊕	75	B
DM astra 450 DM/64					19811	KOMBI Ø370xH65			2x32	GX24q-3	4800	IP20	⊕	75	B
EM astra 450 EM/64					10161	KOMBI Ø370xH65			2x32(a)	GX24q-3	4800	IP20	⊕	75	B

Colore base Frame color

● Nuova versione New version

BL RAL 5017 Blu Blue	GI RAL 1023 Giallo Yellow	RO RAL 3000 Rosso Red	TR Trasparente Transparent	BI RAL 9016 Bianco White
--------------------------------	-------------------------------------	---------------------------------	--------------------------------------	------------------------------------

- Led** Equipaggiata con led 3000K - Equipped with led 3000K
- Led** Equipaggiata con led 4000K - Equipped with led 4000K
- Led DM** **Led DM** **DM** Dimmerabile PUSH/DALI
Dimmable PUSH/DALI (info page10)
- Led EM** **Led EM** **EM** Emergenza (SA) 1h di serie - 3h a richiesta
Emergency 1h standard - 3h on request

(a) Equipaggiato con alimentatore multipotenza per l'utilizzo di lampade da 26W-32W
Equipped with multi-power ballast to use bulbs of 26W-32W

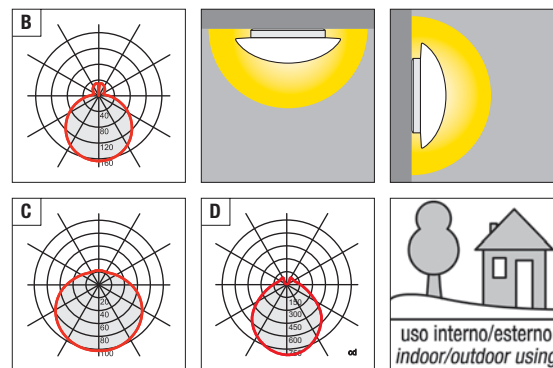

Astra 550

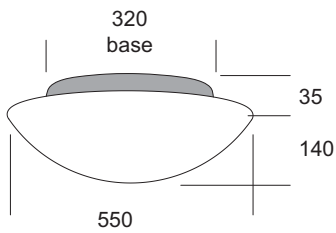

Articolo Item	Colore base Frame color				W _{max}	E27	LUMEN	IP	LUMEN/W	C		
	BL	GI	RO	TR							Codice Code	
<input type="checkbox"/> E27 astra 550 IP					23075 23072 23073 23070	2x57	E27	1830	IP54	□	16	C
● <input type="checkbox"/> Led astra 550 led-W					17125 17122 17123 17120	23,2	led	2680	IP54	⊕	116	D
● <input type="checkbox"/> Led DM astra 550 DM led-W					17145 17142 17143 17140	23,2	led	2680	IP54	⊕	116	D
● <input type="checkbox"/> Led EM astra 550 EM led-W					14265 14262 14263 14260	23,2	led	2680	IP54	⊕	116	D
● <input type="checkbox"/> Led astra 550 led-N					17135 17132 17133 17130	23,2	led	2680	IP54	⊕	116	D
● <input type="checkbox"/> Led DM astra 550 DM led-N					17155 17152 17153 17150	23,2	led	2680	IP54	⊕	116	D
● <input type="checkbox"/> Led EM astra 550 EM led-N					14275 14272 14273 14270	23,2	led	2680	IP54	⊕	116	D
<input type="checkbox"/> EL astra 550 EL IP					28255 28252 28253 28250	2x26	G24q-3	3600	IP54	⊕	69	B
<input type="checkbox"/> DM astra 550 DM IP					28135 28132 28133 28130	2x26	G24q-3	3600	IP54	⊕	69	B
<input type="checkbox"/> EM astra 550 EM IP					10495 10492 10493 10490	2x26	G24q-3	3600	IP54	⊕	69	B
<input type="checkbox"/> BI	Montatura in metallo verniciato bianco. Solo per installazione interna White painted metal frame. Only for indoor installation											
<input type="checkbox"/> EL astra 550 EL/84					19051 KOMBI Ø370xH65	2x42(a)	GX24q-4	6400	IP20	⊕	76	B
<input type="checkbox"/> DM astra 550 DM/84					19821 KOMBI Ø370xH65	2x42	GX24q-4	6400	IP20	⊕	76	B
<input type="checkbox"/> EM astra 550 EM/84					10171 KOMBI Ø370xH65	2x42(a)	GX24q-4	6400	IP20	⊕	76	B

Colore base Frame color

● Nuova versione New version

<input type="checkbox"/> BL RAL 5017 Blu Blue	<input type="checkbox"/> GI RAL 1023 Giallo Yellow	<input type="checkbox"/> RO RAL 3000 Rosso Red	<input type="checkbox"/> TR Trasparente Transparent	<input type="checkbox"/> BI RAL 9016 Bianco White
---	--	--	--	---

Led Equipaggiata con led 3000K - Equipped with led 3000K

Led Equipaggiata con led 4000K - Equipped with led 4000K

Led DM Led DM DM Dimmerabile PUSH/DALI
Dimmable PUSH/DALI (info page10)

Led EM Led EM EM Emergenza (SA) 1h di serie - 3h a richiesta
Emergency 1h standard - 3h on request

(a) Equipaggiato con alimentatore multipotenza per l'utilizzo di lampade da 26W-32W o 42W
Equipped with multi-power ballast to use bulbs of 26W-32W or 42W

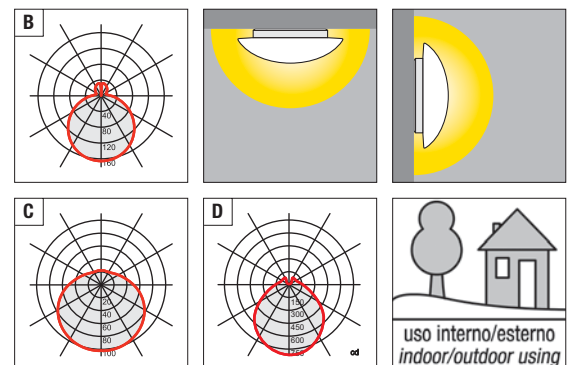

Astra metal

Lampada da soffitto o parete. Diffusore in vetro soffiato opale triplex satinato con sistema di aggancio a baionetta. Base in policarbonato autoestinguente. Fascia in metallo verniciato o con finitura galvanica. Guarnizione in silicone per le versioni IP54 e IP65.

Versione LED equipaggiata con led smd e alimentatore elettronico incorporato.

Ceiling or wall lamp. Diffuser made in blown satin opal triplex glass with bayonet lock system. Base made in auto-extinguishing polycarbonate. Ring made in painted metal or with galvanic finish. Silicon gasket for versions IP54 and IP65.

LED version equipped with smd led and electronic driver included.

Lampe à plafond ou à mur. Diffuseur en verre soufflé opale triplex satiné avec système d'accroche à baïonnette. Base réalisée en polycarbonate auto-extinguible. Anneau réalisé en métal vernie ou avec finition galvanique. Joint en silicone pour les versions IP54 et IP65.

Version LED équipée avec led smd et ballast électronique incorporé.

Lámpara de techo o pared. Difusor de vidrio soplado opal triplex satinado con sistema de enganche a bayoneta. Base en policarbonato de autoextinción. Faja de metal pintado o con acabado galvanico. Junta de protección de silicona para las versiones IP54 y IP65.

Version LED suministrada con led smd y alimentador electronico incluido.

Decken- oder Wandleuchte. Diffusor aus geblasenem Triplex-Opalglas, satiniert, mit Bajonettssystem zur Befestigung. Basis aus selbstlöschendem Polycarbonat. Metallband lackiert oder mit galvanischem Finish. Silikondichtung für die Ausführungen IP54 und IP65.

Ausführung LED zum led smd und integriert Versorgungsgerät elektronisch.





14 applique interni/esterni
wall lights indoor/outdoor

150 plafoniere interni/esterni
ceiling bowls indoor/outdoor

248 testaletto
bed head units

258 sospensioni
suspensions

344 lampade
lamps

384 lampioni ed incassi
bollards & recessed lights

450 indice
index

Astra metal 320

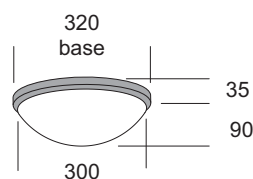

Articolo Item	Colore base Frame color			W _{max}	LUMEN	LUMEN/W	Icone
	AL	NE	CR				
E27 astra 320 IP	23089	23087	23080	1x77	E27	1320	IP65 □ 17 A
● Led astra 320 led-W	17169	17167	17160	10,5	led	1325	IP65 ⊕ 126 D
● Led DM astra 320 DM led-W	17189	17187	17180	10,5	led	1325	IP65 ⊕ 126 D
● Led EM astra 320 EM led-W	14289	14287	14280	10,5	led	1325	IP65 ⊕ 126 D
● Led astra 320 led-N	17179	17177	17170	10,5	led	1325	IP65 ⊕ 126 D
● Led DM astra 320 DM led-N	17199	17197	17190	10,5	led	1325	IP65 ⊕ 126 D
● Led EM astra 320 EM led-N	14299	14297	14290	10,5	led	1325	IP65 ⊕ 126 D
EL astra 320 EL IP	28449	28447	28440	1x26	G24q-3	1800	IP65 ⊕ 69 B
DM astra 320 DM IP	28039	28037	28030	1x26	G24q-3	1800	IP65 ⊕ 69 B
EM astra 320 EM IP	10729	10727	10720	1x18	G24q-2	1200	IP65 ⊕ 67 B

Astra metal 370

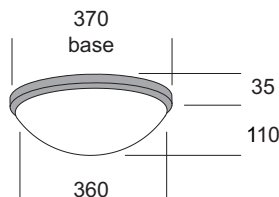

E27 astra 370 IP	23099	23097	23090	2x46	E27	1400	IP65 □ 15 C
● Led astra 370 led-W	17209	17207	17200	15,5	led	1860	IP65 ⊕ 120 D
● Led DM astra 370 DM led-W	17229	17227	17220	15,5	led	1860	IP65 ⊕ 120 D
● Led EM astra 370 EM led-W	14309	14307	14300	15,5	led	1860	IP65 ⊕ 120 D
● Led astra 370 led-N	17219	17217	17210	15,5	led	1860	IP65 ⊕ 120 D
● Led DM astra 370 DM led-N	17239	17237	17230	15,5	led	1860	IP65 ⊕ 120 D
● Led EM astra 370 EM led-N	14319	14317	14310	15,5	led	1860	IP65 ⊕ 120 D
EL astra 370 EL IP	28459	28457	28450	2x18	G24q-2	2400	IP65 ⊕ 67 B
DM astra 370 DM IP	28079	28077	28070	2x18	G24q-2	2400	IP65 ⊕ 67 B
EM astra 370 EM IP	10739	10737	10730	1x26	G24q-3	1800	IP65 ⊕ 69 B

Colore base Frame color

● Nuova versione New version

AL RAL 9006 Alluminio Aluminium	NE RAL 9005 Nero opaco Matt black	CR Cromato Chrome
------------------------------------	--------------------------------------	----------------------

- Led Equipaggiata con led 3000K - Equipped with led 3000K
- Led Equipaggiata con led 4000K - Equipped with led 4000K
- Led DM Dimmerabile PUSH/DALI
Dimmable PUSH/DALI (info page 10)
- Led EM Emergenza (SA) 1h di serie - 3h a richiesta
Emergency 1h standard - 3h on request

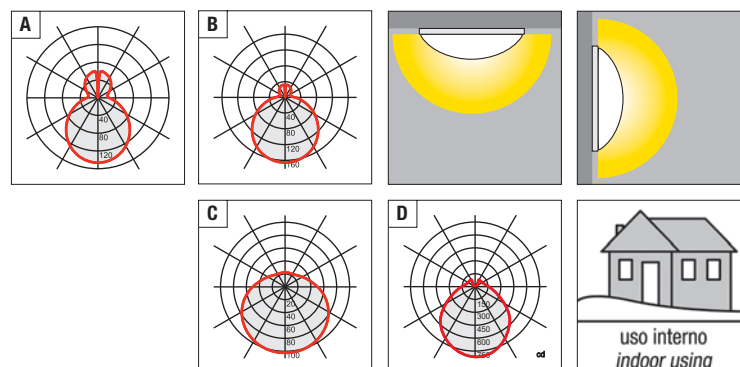

Astra metal 470

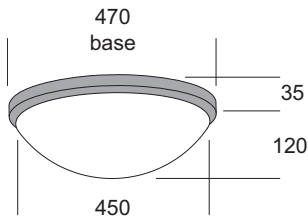

Articolo Item	Colore base Frame color			W _{max}	Icona	LUMEN	Icona	LUMEN/W	Icona
	AL	NE	CR						
E27 astra 470 IP				23x57	E27	1830	IP54	16	C
● Led astra 470 led-W				23,2	led	2680	IP54	116	D
● Led DM astra 470 DM led-W				23,2	led	2680	IP54	116	D
● Led EM astra 470 EM led-W				23,2	led	2680	IP54	116	D
● Led astra 470 led-N				23,2	led	2680	IP54	116	D
● Led DM astra 470 DM led-N				23,2	led	2680	IP54	116	D
● Led EM astra 470 EM led-N				23,2	led	2680	IP54	116	D
EL astra 470 EL IP				2x26	G24q-3	3600	IP54	69	B
DM astra 470 DM IP				2x26	G24q-3	3600	IP54	69	B
EM astra 470 EM IP				2x26	G24q-3	3600	IP54	69	B

Astra metal 570

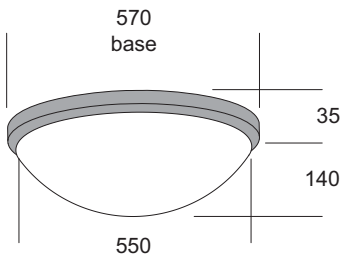

E27 astra 570 IP				23x57	E27	1830	IP54	16	C
● Led astra 570 led-W				23,2	led	2680	IP54	116	D
● Led DM astra 570 DM led-W				23,2	led	2680	IP54	116	D
● Led EM astra 570 EM led-W				23,2	led	2680	IP54	116	D
● Led astra 570 led-N				23,2	led	2680	IP54	116	D
● Led DM astra 570 DM led-N				23,2	led	2680	IP54	116	D
● Led EM astra 570 EM led-N				23,2	led	2680	IP54	116	D
EL astra 570 EL IP				2x26	G24q-3	3600	IP54	69	B
DM astra 570 DM IP				2x26	G24q-3	3600	IP54	69	B
EM astra 570 EM IP				2x26	G24q-3	3600	IP54	69	B

Colore base Frame color

AL RAL 9006 Alluminio Aluminium	NE RAL 9005 Nero opaco Matt black	CR Cromato Chrome
---	---	-----------------------------

● Nuova versione New version

Led Equipaggiata con led 3000K - Equipped with led 3000K

Led Equipaggiata con led 4000K - Equipped with led 4000K

Led DM **Led DM** **DM** Dimmerabile PUSH/DALI
Dimmable PUSH/DALI (info page10)

Led EM **Led EM** **EM** Emergenza (SA) 1h di serie - 3h a richiesta
Emergency 1h standard - 3h on request

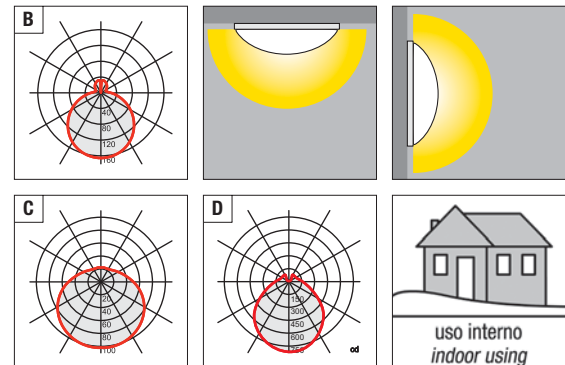



Astra mini 200



Astra mini 170

Astra mini

Faretto ad incasso per illuminazione di ambienti con luce diffusa. Diffusore in vetro soffiato opale triplex satinato con sistema di aggancio a vite. Montatura in metallo verniciato bianco ral 9016. Fascia in metallo verniciato o con finitura galvanica.

Versione LED equipaggiata con led smd e alimentatore elettronico incorporato.

Recessed down-light to illuminate with diffused light. Diffuser made in blown satin opal triplex glass with screw lock system. Frame in white painted metal ral 9016. Ring made in painted metal or with galvanic finish.

LED version equipped with smd led and electronic driver included.

Appareil encastrable pour éclairage avec lumière diffuse. Diffuseur en verre soufflé opale triplex satiné avec système d'accroche à vis. Monture en métal verni blanc ral 9016. Anneau réalisé en métal vernie ou avec finition galvanique.

Version LED équipée avec led smd et ballast électronique incorporé.

Bombilla con encaje para iluminación de ambientes con luz difusa. Difusor de vidrio soplado opal triplex satinado con sistema de engancho a tornillos. Montadura en metal pintado blanco ral 9016. Faja de metal pintado o con acabado galvanico.

Version LED suministrada con led smd y alimentador electronico incluido.

Einbauspot für Räume mit diffusem Licht. Diffusor aus geblasenem Triplex-Opalglas, satiniert, mit Schraubsystem zur Befestigung. Fassung aus weiß lackiertem Metall Ral 9016. Metallband lackiert oder mit galvanischem Finish.

Ausführung LED zum led smd und integriert Versorgungsgerät elektronisch.

Astra mini 170

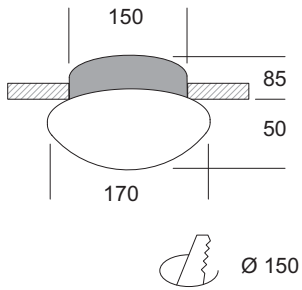

Articolo Item	Codice Code	W _{max}		LUMEN		LUMEN/W	
E27 astra mini 170 E27	20041	1x22	E27 FBT	1440	IP20	65	A
Led astra mini 170 led-W	20091	8,33	led	1090	IP20	131	B
Led astra mini 170 led-N	20101	8,33	led	1090	IP20	131	B
EL astra mini 170 EL	20051	1x26	GX24q-3	1800	IP20	69	A

Astra mini 200

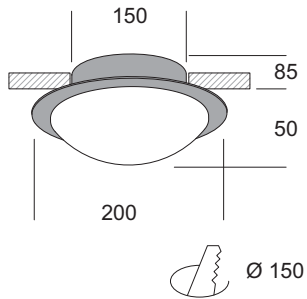

Articolo Item	Colore fascia Ring color			W _{max}		LUMEN		LUMEN/W	
	AL	NE	CR						
E27 astra mini 200 E27	20069	20067	20060	1x22	E27 FBT	1440	IP20	65	A
Led astra mini 200 led-W	20119	20117	20110	8,33	led	1090	IP20	131	B
Led astra mini 200 led-N	20129	20127	20120	8,33	led	1090	IP20	131	B
EL astra mini 200 EL	20079	20077	20070	1x26	GX24q-3	1800	IP20	69	A

Colore fascia Ring color

AL RAL 9006 Alluminio Aluminium	NE RAL 9005 Nero opaco Matt black	CR Cromato Chrome
---	---	-----------------------------

● Nuova versione New version

- Led** Equipaggiata con led 3000K - Equipped with led 3000K
- Led** Equipaggiata con led 4000K - Equipped with led 4000K

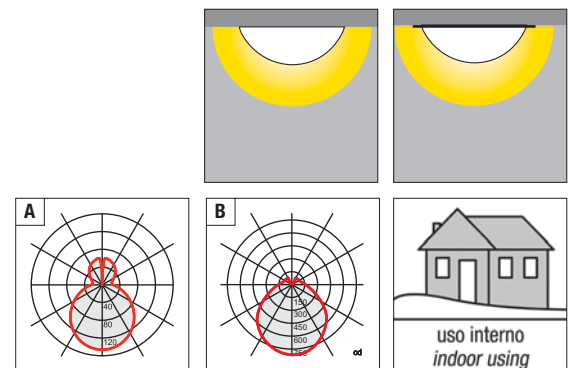



Mega

Lampada da soffitto o parete. Diffusore in vetro soffiato opale triplex satinato con sistema di aggancio a baionetta. La base trasparente o colorata, in policarbonato autoestinguente, permette di creare, sulla parete, un alone colorato mantenendo il flusso di luce centrale bianco. Base KOMBI in metallo verniciato bianco ral 9016. Guarnizione in silicone per le versioni IP65.

Versione LED equipaggiata con led smd e alimentatore elettronico incorporato. Versioni LED24 per installazione in zona 1 (in prossimità di vasche o docce CEI 64-8/7 art.701.32) funzionanti con alimentatore remoto 24V non incluso e acquistabile separatamente.

Ceiling or wall lamp. Diffuser made in blown satin opal triplex glass with bayonet lock system. The transparent or coloured base, made in auto-extinguishing polycarbonate, permits to create, on the wall, a coloured ring leaving the central light in white. Base KOMBI made in white painted metal ral 9016. Silicon gasket for versions IP65.

LED version equipped with smd led and electronic driver included. LED24 versions suitable for installation in zone 1 (near a bathtub or shower CEI 64-8/7 art.701.32) working with 24V remote ballast not included and purchasable separately.

Lampe à plafond ou à mur. Diffuseur en verre soufflé opale triplex satiné avec système d'accroche à baïonnette. La base transparente ou colorée, réalisée en polycarbonate auto-extinguible, permet de créer, sur le mur, un halo coloré conservant la lumière centrale blanche. Base KOMBI réalisée en métal vernie blanc ral 9016. Joint en silicone pour les versions IP65.

Version LED équipée avec led smd et ballast électronique incorporé. Versions LED24 pour installation in zone 1 (près d'une baignoire ou d'une douche CEI 64-8/7 art.701.32) fonctionnant avec ballast 24V à distance pas inclus et vendu séparément.

Lámpara de techo o pared. Difusor de vidrio soplado opal triplex satinado con sistema de enganche a bayoneta. La base transparente o de colores, en policarbonato de autoextinción, permite crear, en la pared, un halo de colores manteniendo el flujo de luz central blanco. Base KOMBI en metal pintado blanco ral 9016. Junta de protección de silicona para las versiones IP65.

Version LED suministrada con led smd y alimentador electrónico incluido. Versiones LED24 para el uso en zona 1 (en las proximidades de las duchas o bañera CEI 64-8/7 art.701.32) usando alimentador 24V a distancia no incluido y que se vende separado.

Decken- oder Wandleuchte. Diffusor aus geblasenem Triplex-Opalglas, satiniert, mit Bajonettssystem zur Befestigung. Die transparente oder farbige Basis, aus selbstlöschendem Polycarbonat, ermöglicht es, an der Wand einen farbigen Lichthof zu erzeugen, wobei der zentrale Lichtfluss weiß bleibt. Basis KOMBI aus weiß lackiertem Metall Ral 9016. Silikondichtung für die Ausführungen IP65.

Ausführung LED zum led smd und integriert Versorgungsgerät elektronisch. LED24 Versionen für den Einsatz in Zone 1 (Nähe Badewanne oder Duschen CEI 64-8/7 art.701.32) mit 24V Fernspeisung nicht inbegriffen und separat erhältlich.



14 applique interni/esterni
wall lights indoor/outdoor

150 plafoniere interni/esterni
ceiling bowls indoor/outdoor

248 testaletto
bed head units

258 sospensioni
suspensions

344 lampade
lamps

384 lampioni ed incassi
bollards & recessed lights

450 indice
index

Mega 250

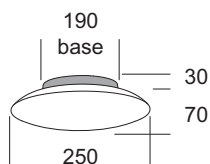

Articolo Item

Colore base Frame color



W_{max}



LUMEN



LUMEN/W



Codice Code

Articolo Item	BL	GI	RO	TR	W _{max}	Beam	LUMEN	IP	Waterproof	LUMEN/W	Energy
E27 mega 250 IP					1x46	E27	700	IP65	□	15	A
● Led mega 250 led-W					8,33	led	1090	IP65	⊕	131	D
● Led 24 mega 250 led24-W					8,33	led24V	1090	IP65	⊕	131	D
● Led DM mega 250 DM led-W					8,33	led	1090	IP65	⊕	131	D
● Led mega 250 led-N					8,33	led	1090	IP65	⊕	131	D
● Led 24 mega 250 led24-N					8,33	led24V	1090	IP65	⊕	131	D
● Led DM mega 250 DM led-N					8,33	led	1090	IP65	⊕	131	D

Mega 350

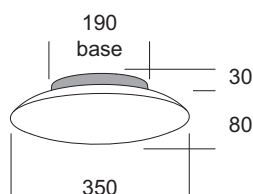

Articolo Item	BL	GI	RO	TR	W _{max}	Beam	LUMEN	IP	Waterproof	LUMEN/W	Energy
E27 mega 350 IP					1x57	E27	915	IP65	□	16	A
● Led mega 350 led-W					8,33	led	1090	IP65	⊕	131	D
● Led 24 mega 350 led24-W					8,33	led24V	1090	IP65	⊕	131	D
● Led DM mega 350 DM led-W					8,33	led	1090	IP65	⊕	131	D
● Led mega 350 led-N					8,33	led	1090	IP65	⊕	131	D
● Led 24 mega 350 led24-N					8,33	led24V	1090	IP65	⊕	131	D
● Led DM mega 350 DM led-N					8,33	led	1090	IP65	⊕	131	D

Colore base Frame color

● Nuova versione New version

BL RAL 5017
Blu Blue

GI RAL 1023
Giallo Yellow

RO RAL 3000
Rosso Red

TR
Trasparente Transparent

BI RAL 9016
Bianco White

Led Equipaggiata con led 3000K - Equipped with led 3000K

Led Equipaggiata con led 4000K - Equipped with led 4000K

Led 24 Installazione in zona 1 (in prossimità di vasche o docce CEI 64-8/7 art.701.32) con alimentatore remoto 24V non incluso e acquistabile separatamente (info pag. 9)
Led 24 Installation in zone 1 (near a bathtub or shower CEI 64-8/7 art.701.32) with 24V remote ballast not included and purchasable separately (info page 9)

Led DM **Led DM** Dimmerabile PUSH/DALI
Dimmable PUSH/DALI (info page 10)

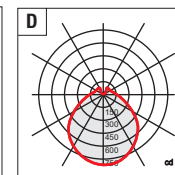
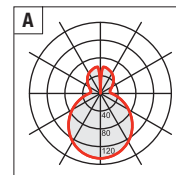
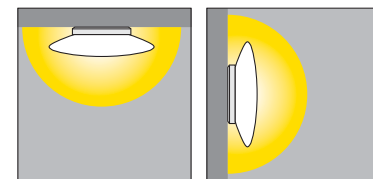

Mega 450

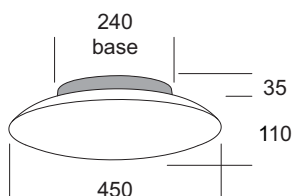

Articolo Item	Colore base Frame color				W _{max}	E27	LUMEN	IP	LUMEN/W	Icon
	BL	GI	RO	TR						
Codice Code										
E27 mega 450 IP	23305	23302	23303	23300	2x46	E27	1400	IP65	15	B
● Led mega 450 led-W	15185	15182	15183	15180	15,5	led	1860	IP65	120	D
● Led DM mega 450 DM led-W	15205	15202	15203	15200	15,5	led	1860	IP65	120	D
● Led EM mega 450 EM led-W	14605	14602	14603	14600	15,5	led	1860	IP65	120	D
● Led mega 450 led-N	15195	15192	15193	15190	15,5	led	1860	IP65	120	D
● Led DM mega 450 DM led-N	15215	15212	15213	15210	15,5	led	1860	IP65	120	D
● Led EM mega 450 EM led-N	14615	14612	14613	14610	15,5	led	1860	IP65	120	D
EL mega 450 EL IP	28545	28542	28543	28540	2x18	G24q-2	2400	IP65	67	C
DM mega 450 DM IP	28195	28192	28193	28190	2x18	G24q-2	2400	IP65	67	C
EM mega 450 EM IP	10535	10532	10533	10530	1x26	G24q-3	1800	IP65	69	C
BI Montatura in metallo verniciato bianco. Solo per installazione interna White painted metal frame. Only for indoor installation										
EM mega 450 EM/36	10541	KOMBI Ø270xH60			2x18	G24q-2	2400	IP20	67	C

Colore base Frame color

● Nuova versione New version

BL RAL 5017 Blu Blue	GI RAL 1023 Giallo Yellow	RO RAL 3000 Rosso Red	TR Trasparente Transparent	BI RAL 9016 Bianco White
--------------------------------	-------------------------------------	---------------------------------	--------------------------------------	------------------------------------

- Led** Equipaggiata con led 3000K - Equipped with led 3000K
- Led** Equipaggiata con led 4000K - Equipped with led 4000K
- Led DM** **Led DM** **DM** Dimmerabile PUSH/DALI
Dimmable PUSH/DALI (info page10)
- Led EM** **Led EM** **EM** Emergenza (SA) 1h di serie – 3h a richiesta
Emergency 1h standard – 3h on request

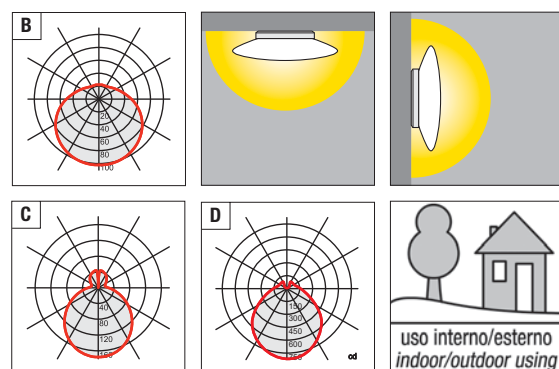

Mega metal

Lampada da soffitto o parete. Diffusore in vetro soffiato opale triplex satinato con sistema di aggancio a baionetta. Base in policarbonato autoestinguente. Fascia in metallo verniciato o con finitura galvanica. Base KOMBI in metallo verniciato bianco ral 9016. Guarnizione in silicone per le versioni IP65.

Versione LED equipaggiata con led smd e alimentatore elettronico incorporato.

Ceiling or wall lamp. Diffuser made in blown satin opal triplex glass with bayonet lock system. Base made in auto-extinguishing polycarbonate. Ring made in painted metal or with galvanic finish. KOMBI made in white painted metal ral 9016. Silicon gasket for versions IP65.

LED version equipped with smd led and electronic driver included.

Lampe à plafond ou à mur. Diffuseur en verre soufflé opale triplex satiné avec système d'accroche à baïonnette. Base réalisée en polycarbonate auto-extinguible. Anneau réalisé en métal vernie ou avec finition galvanique. Base KOMBI réalisée en métal vernie blanc ral 9016. Joint en silicone pour les versions IP65.

Version LED équipée avec led smd et ballast électronique incorporé.

Lámpara de techo o pared. Difusor de vidrio soplado opal triplex satinado con sistema de enganche a bayoneta. Base en policarbonato de autoextinción. Faja de metal pintado o con acabado galvanico. Base KOMBI en metal pintado blanco ral 9016. Junta de protección de silicona para las versiones IP65.

Version LED suministrada con led smd y alimentador electronico incluido.

Decken- oder Wandleuchte. Diffusor aus geblasenem Triplex-Opalglas, satiniert, mit Bajonettssystem zur Befestigung. Basis aus selbstlöschendem Polycarbonat. Metallband lackiert oder mit galvanischem Finish. Basis KOMBI aus weiß lackiertem Metall Ral 9016. Silikondichtung für die Ausführungen IP65.

Ausführung LED zum led smd und integriert Versorgungsgerät elektronisch.



Mega metal 260

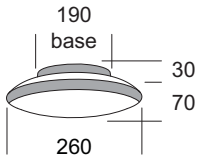

		Colore Fascia Ring color		W _{max}	E27	LUMEN	IP	Beam	LUMEN/W	Icon	
Articolo Item		CR	AL								
		Codice Code									
E27	mega 260 IP	23310	23319	1x46	E27	700	IP65	□	15	A	
Led	mega 260 led-W	15220	15229	8,33	led	1090	IP65	⊕	131	D	
Led DM	mega 260 DM led-W	15240	15249	8,33	led	1090	IP65	⊕	131	D	
Led	mega 260 led-N	15230	15239	8,33	led	1090	IP65	⊕	131	D	
Led DM	mega 260 DM led-N	15250	15259	8,33	led	1090	IP65	⊕	131	D	

Mega metal 360

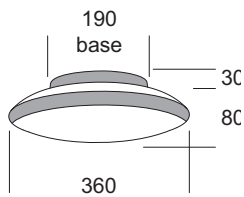

E27	mega 360 IP	23320	23329	1x57	E27	915	IP65	□	16	A
Led	mega 360 led-W	15260	15269	8,33	led	1090	IP65	⊕	131	D
Led DM	mega 360 DM led-W	15280	15289	8,33	led	1090	IP65	⊕	131	D
Led	mega 360 led-N	15270	15279	8,33	led	1090	IP65	⊕	131	D
Led DM	mega 360 DM led-N	15290	15299	8,33	led	1090	IP65	⊕	131	D

Mega metal 460

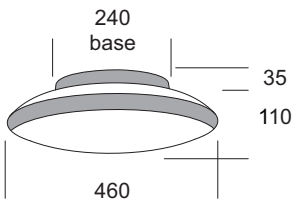

E27	mega 460 IP	23330	23339	2x46	E27	1400	IP65	□	15	B
Led	mega 460 led-W	15300	15309	15,5	led	1860	IP65	⊕	120	D
Led DM	mega 460 DM led-W	15320	15329	15,5	led	1860	IP65	⊕	120	D
Led EM	mega 460 EM led-W	14620	14629	15,5	led	1860	IP65	⊕	120	D
Led	mega 460 led-N	15310	15319	15,5	led	1860	IP65	⊕	120	D
Led DM	mega 460 DM led-N	15330	15339	15,5	led	1860	IP65	⊕	120	D
Led EM	mega 460 EM led-N	14630	14639	15,5	led	1860	IP65	⊕	120	D
EL	mega 460 EL IP	28560	28569	2x18	G24q-2	2400	IP65	⊕	67	C
DM	mega 460 DM IP	28580	28589	2x18	G24q-2	2400	IP65	⊕	67	C
EM	mega 460 EM IP	10860	10869	1x26	G24q-3	1800	IP65	⊕	69	C
EM	mega 460 EM/36	10660	10669	2x18	G24q-2	2400	IP20	⊕	67	C

KOMBI Ø270xH60

Montatura in metallo verniciato bianco. **Solo per installazione interna**
White painted metal frame. **Only for indoor installation**

Colore Fascia Ring color

CR Cromato Chrome
AL RAL 9006 Alluminio Aluminium

● Nuova versione New version

Led Equipaggiata con led 3000K - Equipped with led 3000K

Led Equipaggiata con led 4000K - Equipped with led 4000K

Led DM **Led DM** **DM** Dimmerabile PUSH/DALI
Dimmable PUSH/DALI (info page10)

Led EM **Led EM** **EM** Emergenza (SA) 1h di serie - 3h a richiesta
Emergency 1h standard - 3h on request

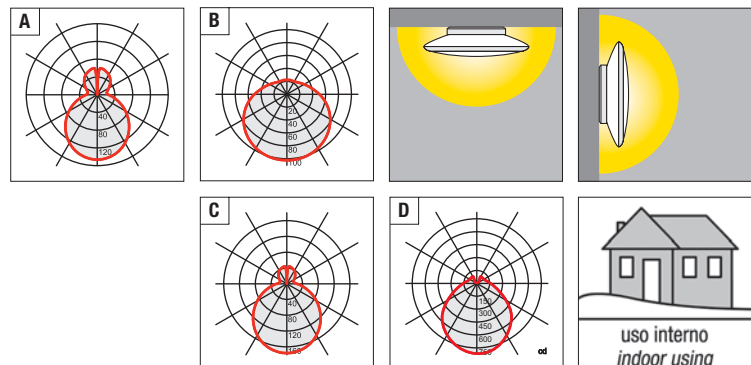

Gamma

Lampada da soffitto o parete. Diffusore in vetro soffiato opale triplex satinato con sistema di aggancio a baionetta. La base trasparente o colorata, in policarbonato autoestinguente, permette di creare, sulla parete, un alone colorato mantenendo il flusso di luce centrale bianco. Base KOMBI in metallo verniciato bianco ral 9016. Guarnizione in silicone per le versioni IP54 e IP65. **Versione LED equipaggiata con led smd e alimentatore elettronico incorporato. Versioni LED24 per installazione in zona 1 (in prossimità di vasche o docce CEI 64-8/7 art.701.32) funzionanti con alimentatore remoto 24V non incluso e acquistabile separatamente.**

Ceiling or wall lamp. Diffuser made in blown satin opal triplex glass with bayonet lock system. The transparent or coloured base, made in auto-extinguishing polycarbonate, permits to create, on the wall, a coloured ring leaving the central light in white. Base KOMBI made in white painted metal ral 9016. Silicon gasket for versions IP54 and IP65. **LED version equipped with smd led and electronic driver included. LED24 versions suitable for installation in zone 1 (near a bathtub or shower CEI 64-8/7 art.701.32) working with 24V remote ballast not included and purchasable separately.**

Lampe à plafond ou à mur. Diffuseur en verre soufflé opale triplex satiné avec système d'accroche à baïonnette. La base transparente ou colorée, réalisée en polycarbonate auto-extinguible, permet de créer, sur le mur, un halo coloré conservant la lumière centrale blanche. Base KOMBI réalisée en métal vernie blanc ral 9016. Joint en silicone pour les versions IP54 et IP65. **Version LED équipée avec led smd et ballast électronique incorporé. Versions LED24 pour installation in zone 1 (près d'une baignoire ou d'une douche CEI 64-8/7 art.701.32) fonctionnant avec ballast 24V à distance pas inclus et vendu séparément.**

Lámpara de techo o pared. Difusor de vidrio soplado opal triplex satinado con sistema de enganche a bayoneta. La base transparente o de colores, en policarbonato de autoextinción, permite crear, en la pared, un halo de colores manteniendo el flujo de luz central blanco. Base KOMBI en metal pintado blanco ral 9016. Junta de protección de silicona para las versiones IP54 y IP65. **Version LED suministrada con led smd y alimentador electronico incluido. Versiones LED24 para el uso en zona 1 (en las proximidades de las duchas o bañera CEI 64-8/7 art.701.32) usando alimentador 24V a distancia no incluido y que se vende separado.**

Decken- oder Wandleuchte. Diffusor aus geblasenem Triplex-Opalglas, satiniert, mit Bajonettsystem zur Befestigung. Die transparente oder farbige Basis, aus selbstlöschendem Polycarbonat, ermöglicht es, an der Wand einen farbigen Lichthof zu erzeugen, wobei der zentrale Lichtfluss weiß bleibt. Basis KOMBI aus weiß lackiertem Metall Ral 9016. Silikondichtung für die Ausführungen IP54 und IP65. **Ausführung LED zum led smd und integriert Versorgungsgerät elektronisch. LED24 Versionen für den Einsatz in Zone 1 (Nähe Badewanne oder Duschen CEI 64-8/7 art.701.32) mit 24V Fernspeisung nicht inbegriffen und separat erhältlich.**





14 applique interni/esterni
wall lights indoor/outdoor

150 plafoniere interni/esterni
ceiling bowls indoor/outdoor

248 testataletto
bed head units

258 sospensioni
suspensions

344 lampade
lamps

384 lampioni ed incassi
bollards & recessed lights

450 indice
index

Gamma 250

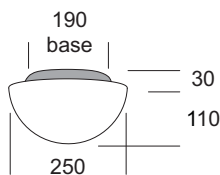

Articolo Item

Colore base Frame color



W_{max}



LUMEN



LUMEN/W



Codice Code

Articolo Item	BL	GI	RO	TR	W _{max}	Socket	LUMEN	IP	LUMEN/W	Code
[E27] gamma 250 IP					1x46	E27	700	IP65	15	A
[Led] gamma 250 led-W					8,33	led	1090	IP65	131	D
[Led 24] gamma 250 led24-W					8,33	led24V	1090	IP65	131	D
[Led DM] gamma 250 DM led-W					8,33	led	1090	IP65	131	D
[Led] gamma 250 led-N					8,33	led	1090	IP65	131	D
[Led 24] gamma 250 led24-N					8,33	led24V	1090	IP65	131	D
[Led DM] gamma 250 DM led-N					8,33	led	1090	IP65	131	D

Gamma 350

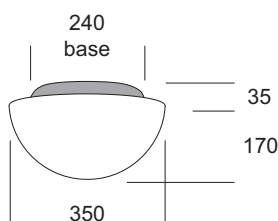

Articolo Item	BL	GI	RO	TR	W _{max}	Socket	LUMEN	IP	LUMEN/W	Code
[E27] gamma 350 IP					2x46	E27	1400	IP65	15	B
[Led] gamma 350 led-W					15,5	led	1860	IP65	120	D
[Led 24] gamma 350 led24-W					15,5	led 24V	1860	IP65	120	D
[Led DM] gamma 350 DM led-W					15,5	led	1860	IP65	120	D
[Led EM] gamma 350 EM led-W					15,5	led	1860	IP65	120	D
[Led] gamma 350 led-N					15,5	led	1860	IP65	120	D
[Led 24] gamma 350 led24-N					15,5	led 24V	1860	IP65	120	D
[Led DM] gamma 350 DM led-N					15,5	led	1860	IP65	120	D
[Led EM] gamma 350 EM led-N					15,5	led	1860	IP65	120	D
[EL] gamma 350 EL IP					2x18	G24q-2	2400	IP65	67	C
[DM] gamma 350 DM IP					2x18	G24q-2	2400	IP65	67	C
[EM] gamma 350 EM IP					1x26	G24q-3	1800	IP65	69	C

[BI] Montatura in metallo verniciato bianco. **Solo per installazione interna**
White painted metal frame. **Only for indoor installation**

[EM] gamma 350 EM/36					10511	KOMBI Ø270xH60	2x18	G24q-2	2400	IP20	67	C
----------------------	--	--	--	--	-------	----------------	------	--------	------	------	----	---

● Nuova versione New version

Colore base Frame color



[Led] Equipaggiata con led 3000K - Equipped with led 3000K

[Led] Equipaggiata con led 4000K - Equipped with led 4000K

[Led 24] Installazione in zona 1 (in prossimità di vasche o docce CEI 64-8/7 art.701.32) con alimentatore remoto 24V non incluso e acquistabile separatamente (info pag. 9)
[Led 24] Installation in zone 1 (near a bathtub or shower CEI 64-8/7 art.701.32) with 24V remote ballast not included and purchasable separately (info page 9)

[Led DM] [Led DM] [DM] Dimmerabile PUSH/DALI
Dimmable PUSH/DALI (info page 10)

[Led EM] [Led EM] [EM] Emergenza (SA) 1h di serie - 3h a richiesta
Emergency 1h standard - 3h on request

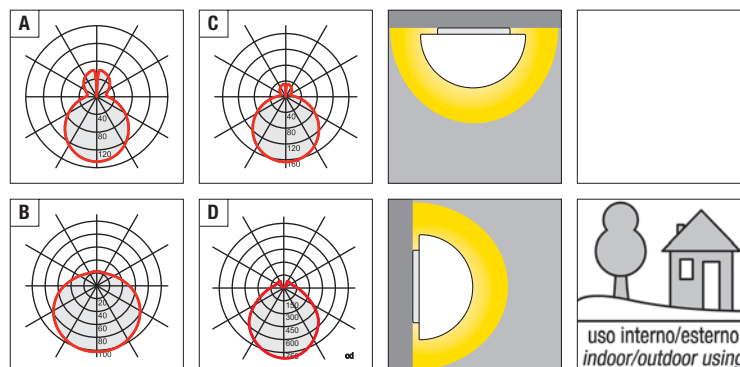

Famiglia prodotto
Product family

Plafoniere Ceiling bowls
Pag. 212

Gamma 450

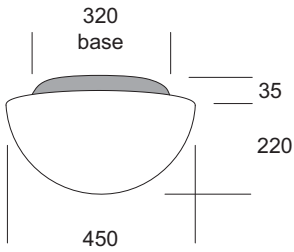

Articolo Item	Colore base Frame color				W _{max}	E27	LUMEN	IP	LUMEN/W	Icon		
	BL	GI	RO	TR								
	Codice Code											
E27 gamma 450 IP					23215 23212 23213 23210	2x57	E27	1830	IP54	□	16	B
● Led gamma 450 led-W					17825 17822 17823 17820	23,2	led	2680	IP54	⊕	116	D
● Led DM gamma 450 DM led-W					17845 17842 17843 17840	23,2	led	2680	IP54	⊕	116	D
● Led EM gamma 450 EM led-W					14485 14482 14483 14480	23,2	led	2680	IP54	⊕	116	D
● Led gamma 450 led-N					17835 17832 17833 17830	23,2	led	2680	IP54	⊕	116	D
● Led DM gamma 450 DM led-N					17855 17852 17853 17850	23,2	led	2680	IP54	⊕	116	D
● Led EM gamma 450 EM led-N					14495 14492 14493 14490	23,2	led	2680	IP54	⊕	116	D
EL gamma 450 EL IP					28315 28312 28313 28310	2x26	G24q-3	3600	IP54	⊕	69	C
DM gamma 450 DM IP					28185 28182 28183 28180	2x26	G24q-3	3600	IP54	⊕	69	C
EM gamma 450 EM IP					10525 10522 10523 10520	2x26	G24q-3	3600	IP54	⊕	69	C
BI Montatura in metallo verniciato bianco. Solo per installazione interna White painted metal frame. Only for indoor installation												
EL gamma 450 EL/64					19161 KOMBI Ø370xH65	2x32(a)	GX24q-3	4800	IP20	⊕	75	C
DM gamma 450 DM/64					19841 KOMBI Ø370xH65	2x32	GX24q-3	4800	IP20	⊕	75	C
EM gamma 450 EM/64					10231 KOMBI Ø370xH65	2x32(a)	GX24q-3	4800	IP20	⊕	75	C

Colore base Frame color

● Nuova versione New version

BL RAL 5017 Blu Blue	GI RAL 1023 Giallo Yellow	RO RAL 3000 Rosso Red	TR Trasparente Transparent	BI RAL 9016 Bianco White
--------------------------------	-------------------------------------	---------------------------------	--------------------------------------	------------------------------------

- Led** Equipaggiata con led 3000K - Equipped with led 3000K
- Led** Equipaggiata con led 4000K - Equipped with led 4000K
- Led DM** **Led DM** **DM** Dimmerabile PUSH/DALI
Dimmable PUSH/DALI (info page10)
- Led EM** **Led EM** **EM** Emergenza (SA) 1h di serie – 3h a richiesta
Emergency 1h standard – 3h on request

(a) Equipaggiato con alimentatore multipotenza per l'utilizzo di lampade da 26W-32W
Equipped with multi-power ballast to use bulbs of 26W-32W

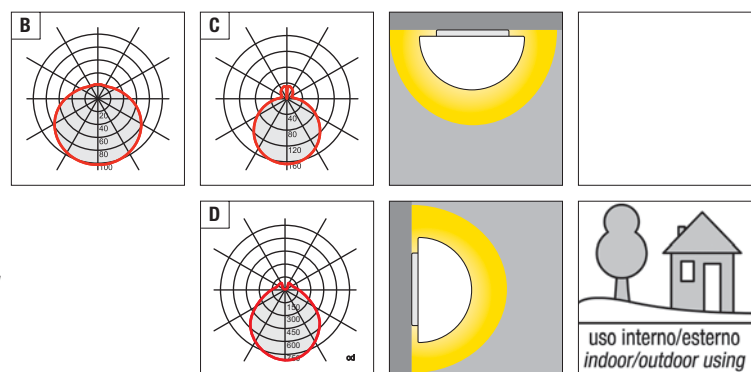



Gamma metal

Lampada da soffitto o parete. Diffusore in vetro soffiato opale triplex satinato con sistema di aggancio a baionetta. Base in policarbonato autoestinguente. Fascia in metallo verniciato o con finitura galvanica. Guarnizione in silicone per le versioni IP54 e IP65.

Versione LED equipaggiata con led smd e alimentatore elettronico incorporato.

Ceiling or wall lamp. Diffuser made in blown satin opal triplex glass with bayonet lock system. Base made in auto-extinguishing polycarbonate. Ring made in painted metal or with galvanic finish. Silicon gasket for versions IP54 and IP65.

LED version equipped with smd led and electronic driver included.

Lampe à plafond ou à mur. Diffuseur en verre soufflé opale triplex satiné avec système d'accroche à baïonnette. Base réalisée en polycarbonate auto-extinguible. Anneau réalisé en métal vernie ou avec finition galvanique. Joint en silicone pour les versions IP54 et IP65.

Version LED équipée avec led smd et ballast électronique incorporé.

Lámpara de techo o pared. Difusor de vidrio soplado opal triplex satinado con sistema de enganche a bayoneta. Base en policarbonato de autoextinción. Faja de metal pintado o con acabado galvanico. Junta de protección de silicona para las versiones IP54 y IP65.

Version LED suministrada con led smd y alimentador electrónico incluido.

Decken- oder Wandleuchte. Diffusor aus geblasenem Triplex-Opalglas, satiniert, mit Bajonettsystem zur Befestigung. Basis aus selbstlöschendem Polycarbonat. Metallband lackiert oder mit galvanischem Finish. Silikondichtung für die Ausführungen IP54 und IP65.

Ausführung LED zum led smd und integriert Versorgungsgerät elektronisch.



14 applique interni/esterni
wall lights indoor/outdoor

150 plafoniere interni/esterni
ceiling bowls indoor/outdoor

248 testaletto
bed head units

258 sospensioni
suspensions

344 lampade
lamps

384 lampioni ed incassi
bollards & recessed lights

450 indice
index

Gamma metal 270

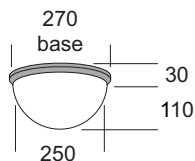

Articolo Item	Colore base Frame color			W _{max}	LUMEN	IP	LUMEN/W	Icon		
	CR	OR	BI							
E27 gamma 270 IP	23220	23222	23221	1x46	E27	700	IP65	□	15	A
Led gamma 270 led-W	17860	17862	17861	8,33	led	1090	IP65	⊕	131	D
Led DM gamma 270 DM led-W	17880	17882	17881	8,33	led	1090	IP65	⊕	131	D
Led gamma 270 led-N	17870	17872	17871	8,33	led	1090	IP65	⊕	131	D
Led DM gamma 270 DM led-N	17890	17892	17891	8,33	led	1090	IP65	⊕	131	D

Gamma metal 370

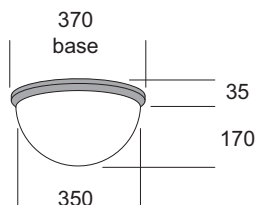

E27 gamma 370 IP	23230	23232	23231	2x46	E27	1400	IP65	□	15	B
Led gamma 370 led-W	17900	17902	17901	15,5	led	1860	IP65	⊕	120	D
Led DM gamma 370 DM led-W	17920	17922	17921	15,5	led	1860	IP65	⊕	120	D
Led EM gamma 370 EM led-W	14500	14502	14501	15,5	led	1860	IP65	⊕	120	D
Led gamma 370 led-N	17910	17912	17911	15,5	led	1860	IP65	⊕	120	D
Led DM gamma 370 DM led-N	17930	17932	17931	15,5	led	1860	IP65	⊕	120	D
Led EM gamma 370 EM led-N	14510	14512	14511	15,5	led	1860	IP65	⊕	120	D
EL gamma 370 EL IP	28480	28482	28481	2x18	G24q-2	2400	IP65	⊕	67	C
DM gamma 370 DM IP	18860	18862	18861	2x18	G24q-2	2400	IP65	⊕	67	C
EM gamma 370 EM IP	10820	10822	10821	1x26	G24q-3	1800	IP65	⊕	69	C

Colore base Frame color

● Nuova versione New version

CR Cromato Chrome	OR Dorato 24K Gold plated 24K	BI RAL 9016 Bianco opaco Matt white
-------------------	-------------------------------	-------------------------------------

- Led Equipaggiata con led 3000K - Equipped with led 3000K
- Led Equipaggiata con led 4000K - Equipped with led 4000K
- Led DM Led DM DM Dimmerabile PUSH/DALI
Dimmable PUSH/DALI (info page 10)
- Led EM Led EM EM Emergenza (SA) 1h di serie - 3h a richiesta
Emergency 1h standard - 3h on request

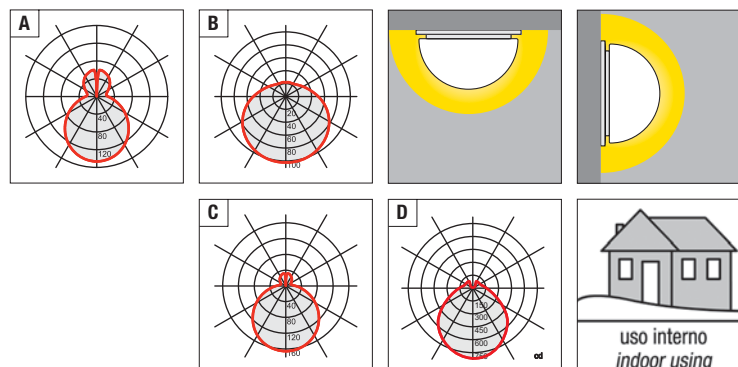

Gamma metal 470

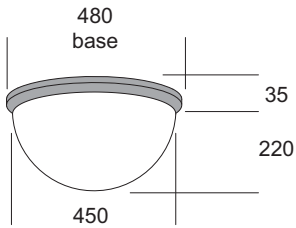

Articolo Item	Colore base Frame color			W _{max}	E27	LUMEN	IP	Icon	LUMEN/W	Icon
	CR	OR	BI							
<input type="checkbox"/> E27 gamma 470 IP				2x57	E27	1830	IP54		16	B
<input checked="" type="checkbox"/> Led gamma 470 led-W				23,2	led	2680	IP54		116	D
<input checked="" type="checkbox"/> Led DM gamma 470 DM led-W				23,2	led	2680	IP54		116	D
<input checked="" type="checkbox"/> Led EM gamma 470 EM led-W				23,2	led	2680	IP54		116	D
<input checked="" type="checkbox"/> Led gamma 470 led-N				23,2	led	2680	IP54		116	D
<input checked="" type="checkbox"/> Led DM gamma 470 DM led-N				23,2	led	2680	IP54		116	D
<input checked="" type="checkbox"/> Led EM gamma 470 EM led-N				23,2	led	2680	IP54		116	D
<input type="checkbox"/> EL gamma 470 EL IP				2x26	G24q-3	3600	IP54		69	C
<input type="checkbox"/> DM gamma 470 DM IP				2x26	G24q-3	3600	IP54		69	C
<input type="checkbox"/> EM gamma 470 EM IP				2x26	G24q-3	3600	IP54		69	C

Colore base Frame color

<input type="checkbox"/> CR Cromato Chrome	<input type="checkbox"/> OR Dorato 24K Gold plated 24K	<input type="checkbox"/> BI RAL 9016 Bianco opaco Matt white
--	--	---

● Nuova versione New version

- Led** Equipaggiata con led 3000K - Equipped with led 3000K
- Led** Equipaggiata con led 4000K - Equipped with led 4000K
- Led DM** **Led DM** **DM** Dimmerabile PUSH/DALI
Dimmable PUSH/DALI (info page10)
- Led EM** **Led EM** **EM** Emergenza (SA) 1h di serie – 3h a richiesta
Emergency 1h standard – 3h on request

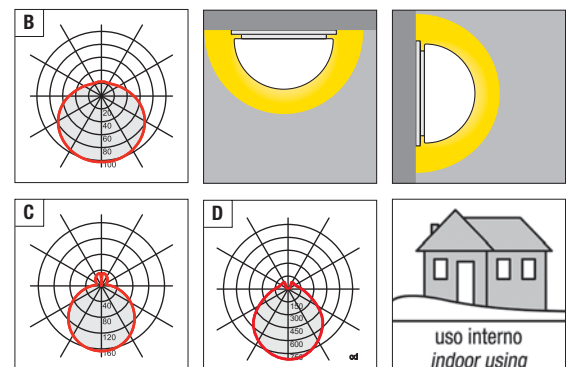



Beta

Lampada da soffitto o parete. Diffusore in vetro soffiato opale triplex lucido con sistema di aggancio a baionetta. Base in policarbonato autoestinguente. Fascia in alluminio verniciata o con finitura galvanica. Guarnizione in silicone.

Versione LED equipaggiata con led smd e alimentatore elettronico incorporato.

Ceiling or wall lamp. Diffuser made in blown shiny opal triplex glass with bayonet lock system. Base made in auto-extinguishing polycarbonate. Ring made in painted aluminium or with galvanic finish. Silicon gasket.

LED version equipped with smd led and electronic driver included.

Lampe à plafond ou à mur. Diffuseur en verre soufflé opale triplex brillant avec système d'accroche à baïonnette. Base réalisée en polycarbonate auto-extinguible. Anneau réalisé en aluminium vernie ou avec finition galvanique. Joint en silicone.

Version LED équipée avec led smd et ballast électronique incorporé.

Lámpara de techo o pared. Difusor de vidrio soplado opal triplex brillante con sistema de enganche a bayoneta. Base en policarbonato de autoextinción. Faja de aluminio pintado o con acabado galvánico. Junta de protección de silicona.

Version LED suministrada con led smd y alimentador electrónico incluido.

Decken- oder Wandleuchte. Diffusor aus geblasenem Triplex-Opalglas, glänzend, mit Bajonettssystem zur Befestigung. Basis aus selbstlöschendem Polycarbonat. Aluminiumband lackiert oder mit galvanischem Finish. Silikondichtung.

Ausführung LED zum led smd und integriert Versorgungsgerät elektronisch.

Beta

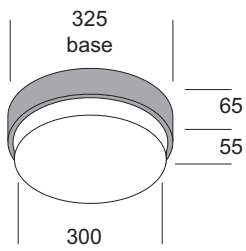

Articolo Item	Colore fascia Ring color				W _{max}	E27	LUMEN	IP	LUMEN/W	Icon	A
	AT	BI	GR	CR							
	Codice Code										
E27 beta	23127	23121	23126	23120	1x77	E27	1320	IP65	☐	17	A
● Led beta led-W	17327	17321	17326	17320	10,5	led	1325	IP65	⊕	126	C
● Led DM beta DM led-W	17347	17341	17346	17340	10,5	led	1325	IP65	⊕	126	C
● Led EM beta EM led-W	14367	14361	14366	14360	10,5	led	1325	IP65	⊕	126	C
● Led beta led-N	17337	17331	17336	17330	10,5	led	1325	IP65	⊕	126	C
● Led DM beta DM led-N	17357	17351	17356	17350	10,5	led	1325	IP65	⊕	126	C
● Led EM beta EM led-N	14377	14371	14376	14370	10,5	led	1325	IP65	⊕	126	C
EL beta EL	18027	18021	18026	18020	1x26	G24q-3	1800	IP65	⊕	69	B
DM beta DM	18767	18761	18766	18760	1x26	G24q-3	1800	IP65	⊕	69	B
EM beta EM	10767	10761	10766	10760	1x18	G24q-2	1200	IP65	⊕	67	B

Colore fascia Ring color

● Nuova versione New version

AT RAL 7016
Antracite gofrato Embossed anthracite

BI RAL 9016
Bianco gofrato Embossed white

GR RAL 9006
Grigio gofrato Embossed grey

CR
Cromato Chrome

Led Equipaggiata con led 3000K - Equipped with led 3000K

Led Equipaggiata con led 4000K - Equipped with led 4000K

Led DM **DM** Dimmerabile PUSH/DALI
Dimmable PUSH/DALI (info page10)

Led EM **EM** Emergenza (SA) 1h di serie – 3h a richiesta
Emergency 1h standard – 3h on request

CR Solo per installazione interna
Only for indoor installation

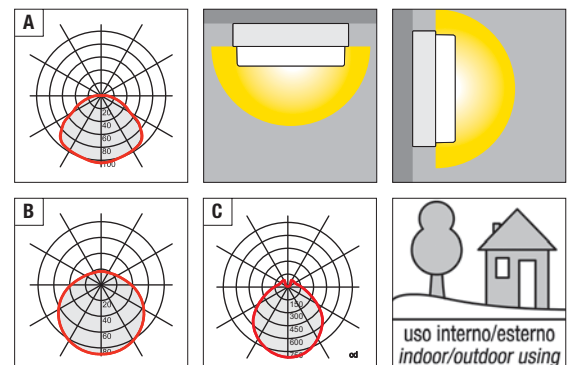

14 applique interni/esterni
wall lights indoor/outdoor

150 plafoniere interni/esterni
ceiling bowls indoor/outdoor

248 testataletto
bed head units

258 sospensioni
suspensions

344 lampade
lamps

384 lampioni ed incassi
bollards & recessed lights

450 indice
index



Delta

Lampada da soffitto o parete. Diffusore in vetro soffiato opale triplex satinato con sistema di aggancio a baionetta. Base in policarbonato autoestinguente. Fascia in alluminio verniciata o con finitura galvanica. Guarnizione in silicone.

Versione LED equipaggiata con led smd e alimentatore elettronico incorporato.

Ceiling or wall lamp. Diffuser made in blown satin opal triplex glass with bayonet lock system. Base made in auto-extinguishing polycarbonate. Ring made in painted aluminium or with galvanic finish. Silicon gasket.

LED version equipped with smd led and electronic driver included.

Lampe à plafond ou à mur. Diffuseur en verre soufflé opale triplex satiné avec système d'accroche à baïonnette. Base réalisée en polycarbonate auto-extinguible. Anneau réalisé en aluminium vernie ou avec finition galvanique. Joint en silicone.

Version LED équipée avec led smd et ballast électronique incorporé.

Lámpara de techo o pared. Difusor de vidrio soplado opal triplex satinado con sistema de enganche a bayoneta. Base en policarbonato de autoextinción. Faja de aluminio pintado o con acabado galvanico. Junta de protección de silicona.

Version LED suministrada con led smd y alimentador electrónico incluido.

Decken- oder Wandleuchte. Diffusor aus geblasenem Triplex-Opalglas, satiniert, mit Bajonettssystem zur Befestigung. Basis aus selbstlöschendem Polycarbonat. Aluminiumband lackiert oder mit galvanischem Finish. Silikondichtung.

Ausführung LED zum led smd und integriert Versorgungsgerät elektronisch.

Delta

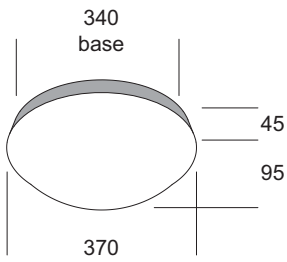

Articolo Item	Colore base Frame color				W _{max}	Icon	LUMEN	Icon	LUMEN/W	Icon	
	AT	BI	GR	CR							
	Codice Code										
E27 delta	23167	23161	23166	23160	2x46	E27	1400	IP65	□	15	A
● Led delta led-W	17547	17541	17546	17540	15,5	led	1860	IP65	⊕	120	C
● Led DM delta DM led-W	17567	17561	17566	17560	15,5	led	1860	IP65	⊕	120	C
● Led EM delta EM led-W	14427	14421	14426	14420	15,5	led	1860	IP65	⊕	120	C
● Led delta led-N	17557	17551	17556	17550	15,5	led	1860	IP65	⊕	120	C
● Led DM delta DM led-N	17577	17571	17576	17570	15,5	led	1860	IP65	⊕	120	C
● Led EM delta EM led-N	14437	14431	14436	14430	15,5	led	1860	IP65	⊕	120	C
EL delta EL	18677	18671	18676	18670	2x18	G24q-2	2400	IP65	⊕	67	B
DM delta DM	18847	18841	18846	18840	2x18	G24q-2	2400	IP65	⊕	67	B
EM delta EM	10817	10811	10816	10810	1x26	G24q-3	1800	IP65	⊕	69	B

Colore base Frame color

AT RAL 7016 Antracite gofrato <i>Embossed anthracite</i>	BI RAL 9016 Bianco gofrato <i>Embossed white</i>	GR RAL 9006 Grigio gofrato <i>Embossed grey</i>	CR Cromato <i>Chrome</i>
---	---	--	------------------------------------

- Led** Equipaggiata con led 3000K - *Equipped with led 3000K*
- Led** Equipaggiata con led 4000K - *Equipped with led 4000K*
- Led DM** **Led DM** **DM** Dimmerabile PUSH/DALI
Dimmable PUSH/DALI (info page10)
- Led EM** **Led EM** **EM** Emergenza (SA) 1h di serie – 3h a richiesta
Emergency 1h standard – 3h on request
- CR** Solo per installazione interna
Only for indoor installation

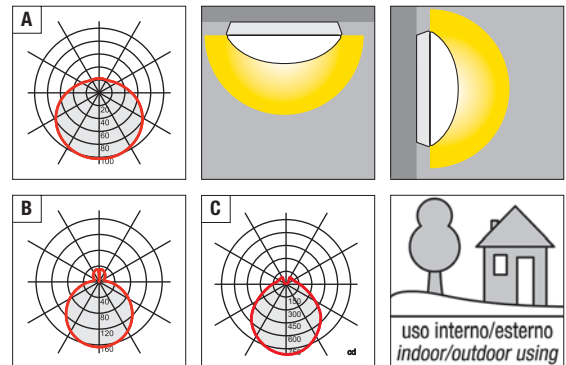

14 applique interni/esterni
wall lights indoor/outdoor

150 plafoniere interni/esterni
ceiling bowls indoor/outdoor

248 testataletto
bed head units

258 sospensioni
suspensions

344 lampade
lamps

384 lampioni ed incassi
bollards & recessed lights

450 indice
index

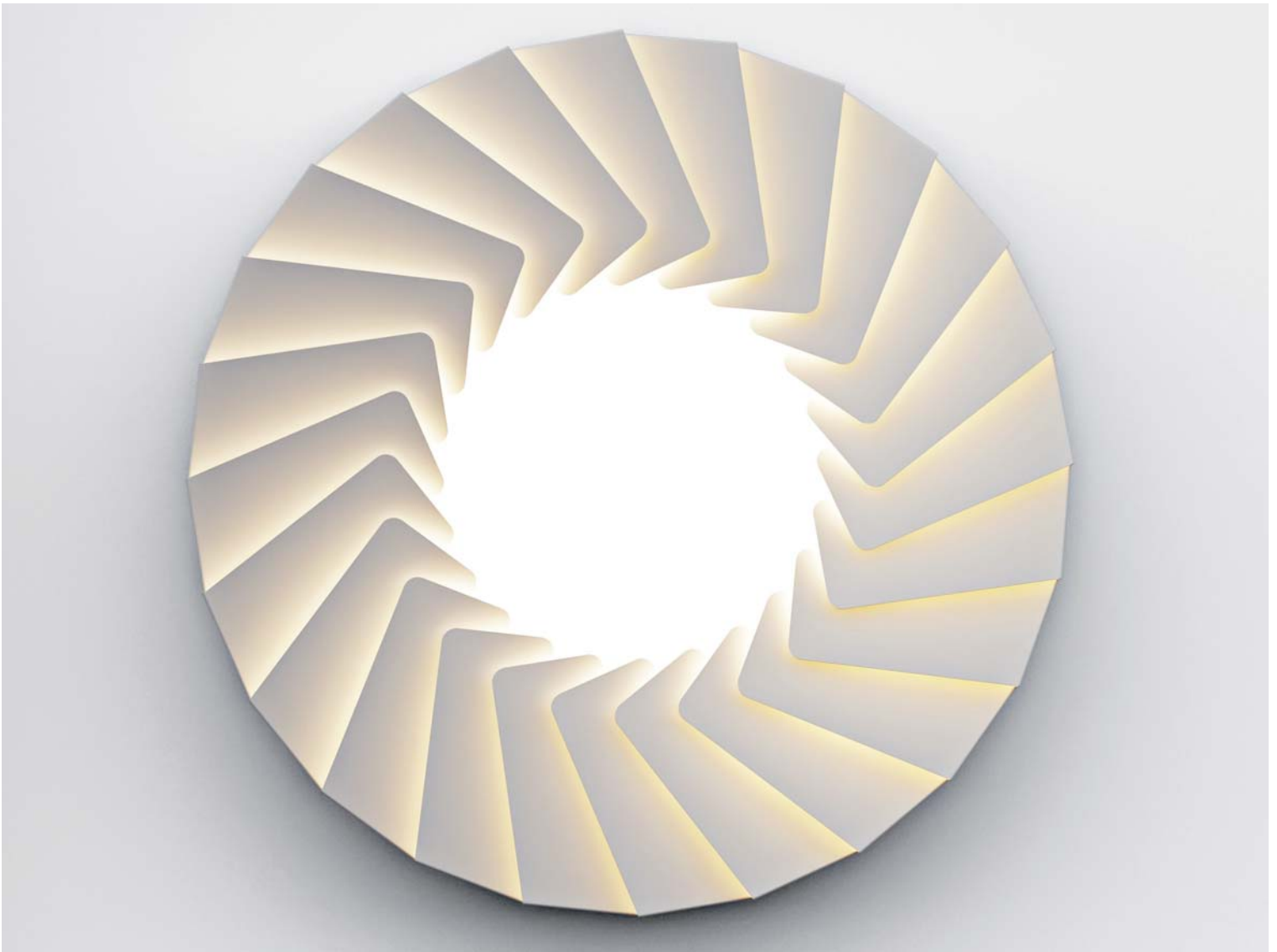

Griffe

Lampada da soffitto o parete. Struttura costituita da parti in metallo verniciato bianco opaco che determinano un originale gioco di luce. Diffusore in policarbonato opale. Montatura in metallo verniciato bianco ral 9016. La versione RGB per missaggio di luci colorate è equipaggiata con LED smd Full Color, alimentatore elettronico e modulo per controllo ciclo colore incorporati. **Versione LED equipaggiata con led smd e alimentatore elettronico incorporato.**

Ceiling or wall lamp. Structure made in metal parts white matt painted that permit an original play of light. Diffusers made in opal polycarbonate. Frame made in white painted metal ral 9016. RGB version for coloured lights mixing is equipped with LED smd Full Color, electronic gear included to control colour cycle. **LED version equipped with smd led and electronic driver included.**

Lampe à plafond ou à mur. Structure réalisée en parties de métal vernie blanc opaque qui permettent un jeu de lumière original. Diffuseurs en polycarbonate opale. Monture réalisée en métal vernie blanc ral 9016. Version RGB pour mixage de lumières colorées équipée avec LED smd Full Color, ballast électronique incorporé pour contrôler le cycle des couleurs. **Version LED équipée avec led smd et ballast électronique incorporé.**

Lámpara de techo o pared. Estructura está hecha de piezas de metal pintado blanco opaco que determinan un original juego de luz. Difusores de policarbonato opale. Montadura de metal pintado blanco ral 9016. Versión RGB para mezclar las luces coloreadas es suministrado con LED smd Full Color, alimentador electrónico incorporado con módulo para el control del ciclo de color. **Version LED suministrada con led smd y alimentador electrónico incluido.**

Decken- oder Wandleuchte. Struktur aus mattweiß lackiertem Metall, die ein originelles Lichtspiel erzeugt. Diffusor aus opalem Polycarbonat. Fassung aus weiß lackiertem Metall ral 9016. Ausführung RGB zur Mischung bunter Lichter Ausführung zum LED smd Full Color, elektronisches Versorgungsgerät mit Modul zur Farbzykluskontrolle integriert. **Ausführung LED zum led smd und integriert Versorgungsgerät elektronisch.**

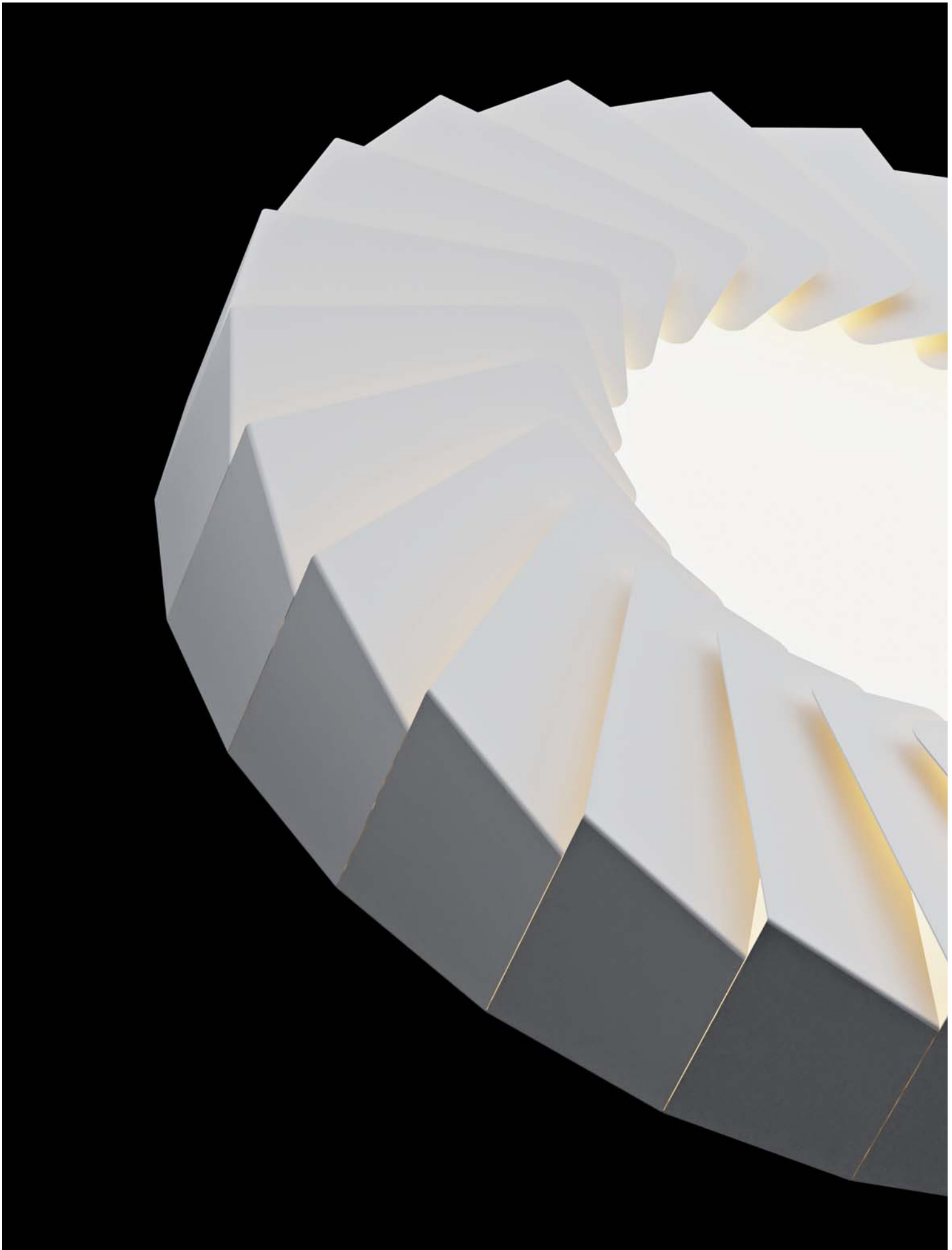

14 applique interni/esterni
wall lights indoor/outdoor

150 plafoniere interni/esterni
ceiling bowls indoor/outdoor



























248 testaletto
bed head units

258 sospensioni
suspensions

344 lampade
lamps

384 lampioni ed incassi
bollards & recessed lights

450 indice
index

Griffe 400		Colore struttura Structure color		W _{max}		LUMEN		LUMEN/W	
Articolo Item	BI	Codice Code							
 griffe 400		11111	2x46	E27	1400	IP20		15	A
 griffe 400 led-W		16821	15,3	led	2070	IP20		135	B
 griffe 400 DM led-W		16841	15,3	led	2070	IP20		135	B
 griffe 400 EM led-W		14101	15,3	led	2070	IP20		135	B
 griffe 400 led-N		16831	15,3	led	2070	IP20		135	B
 griffe 400 DM led-N		16851	15,3	led	2070	IP20		135	B
 griffe 400 EM led-N		14111	15,3	led	2070	IP20		135	B
 griffe 400 EL		18961	2x26	G24q-3	3600	IP20		69	A
 griffe 400 DM		18971	2x26	G24q-3	3600	IP20		69	A
 griffe 400 EM		14121	2x26	G24q-3	3600	IP20		69	A
 griffe 400 RGB DIG		14131	28	led RGB	1680	IP20		60	(nd)
 griffe 400 RGB DALI		14141	28	led RGB	1680	IP20		60	(nd)

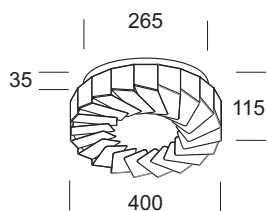

Colore struttura Structure color

 **RAL 9016**
Bianco opaco *Matt white*

 Equipaggiata con led 3000K - *Equipped with led 3000K*

 Equipaggiata con led 4000K - *Equipped with led 4000K*

   Dimmerabile PUSH/DALI
Dimmable PUSH/DALI (info page 10)

   Emergenza (SA) 1h di serie – 3h a richiesta
Emergency 1h standard – 3h on request

  Apparecchio con sistema RGB.
Fitting with RGB system. (info page 10)

(nd) non disponibile – *not available.*

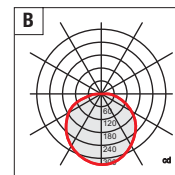
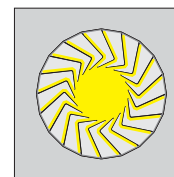
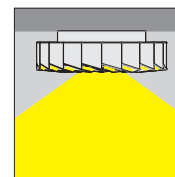
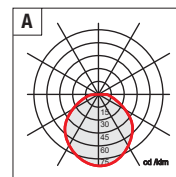

Griffe 600

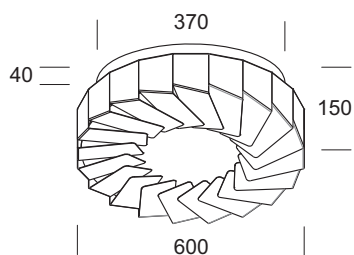

Articolo Item	Colore struttura Structure color		W _{max}	E27	LUMEN	IP	LUMEN/W	A
	BI	Codice Code						
E27 griffe 600		11121	3x46	E27	2100	IP20	15	A
Led griffe 600 led-W		16861	21,7	led	2600	IP20	120	B
Led DM griffe 600 DM led-W		16881	21,7	led	2600	IP20	120	B
Led EM griffe 600 EM led-W		14151	21,7	led	2600	IP20	120	B
Led griffe 600 led-N		16871	21,7	led	2600	IP20	120	B
Led DM griffe 600 DM led-N		16891	21,7	led	2600	IP20	120	B
Led EM griffe 600 EM led-N		14161	21,7	led	2600	IP20	120	B
EL griffe 600 EL		18981	2x32(a)	GX24q-3	4800	IP20	75	A
DM griffe 600 DM		18991	2x32	GX24q-3	4800	IP20	75	A
EM griffe 600 EM		14171	2x32(a)	GX24q-3	4800	IP20	75	A
DIG griffe 600 RGB DIG		14181	28	led RGB	1680	IP20	60	(nd)
DALI griffe 600 RGB DALI		14191	28	led RGB	1680	IP20	60	(nd)

Colore struttura Structure color

BI RAL 9016
Bianco opaco Matt white

Led Equipaggiata con led 3000K - Equipped with led 3000K

Led Equipaggiata con led 4000K - Equipped with led 4000K

Led DM Led DM DM Dimmerabile PUSH/DALI
Dimmable PUSH/DALI (info page 10)

Led EM Led EM EM Emergenza (SA) 1h di serie - 3h a richiesta
Emergency 1h standard - 3h on request

DIG DALI Apparecchio con sistema RGB.
Fitting with RGB system. (info page 10)

(a) Equipaggiato con alimentatore multipotenza per l'utilizzo di lampade da 26W o 32W.
Equipped with multi-power ballast to use bulbs of 26W or 32W.

(nd) non disponibile - not available.

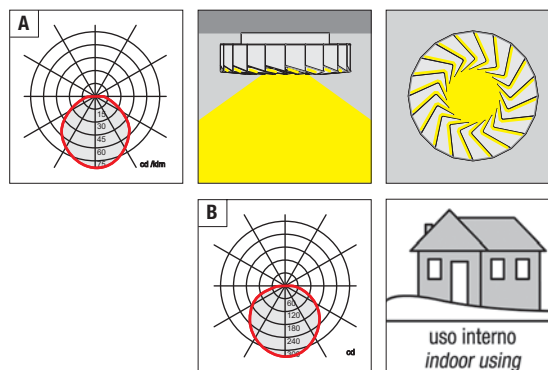

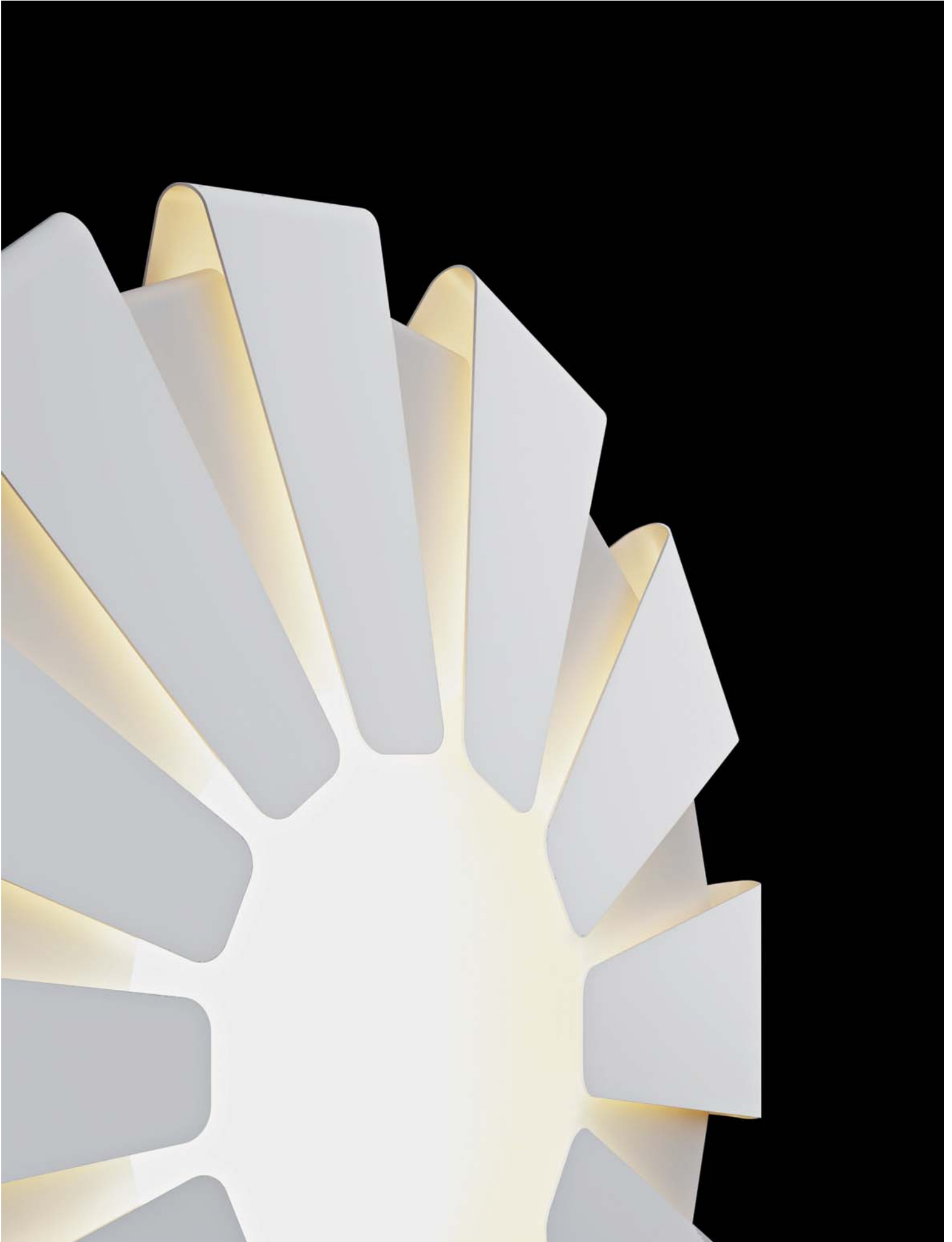

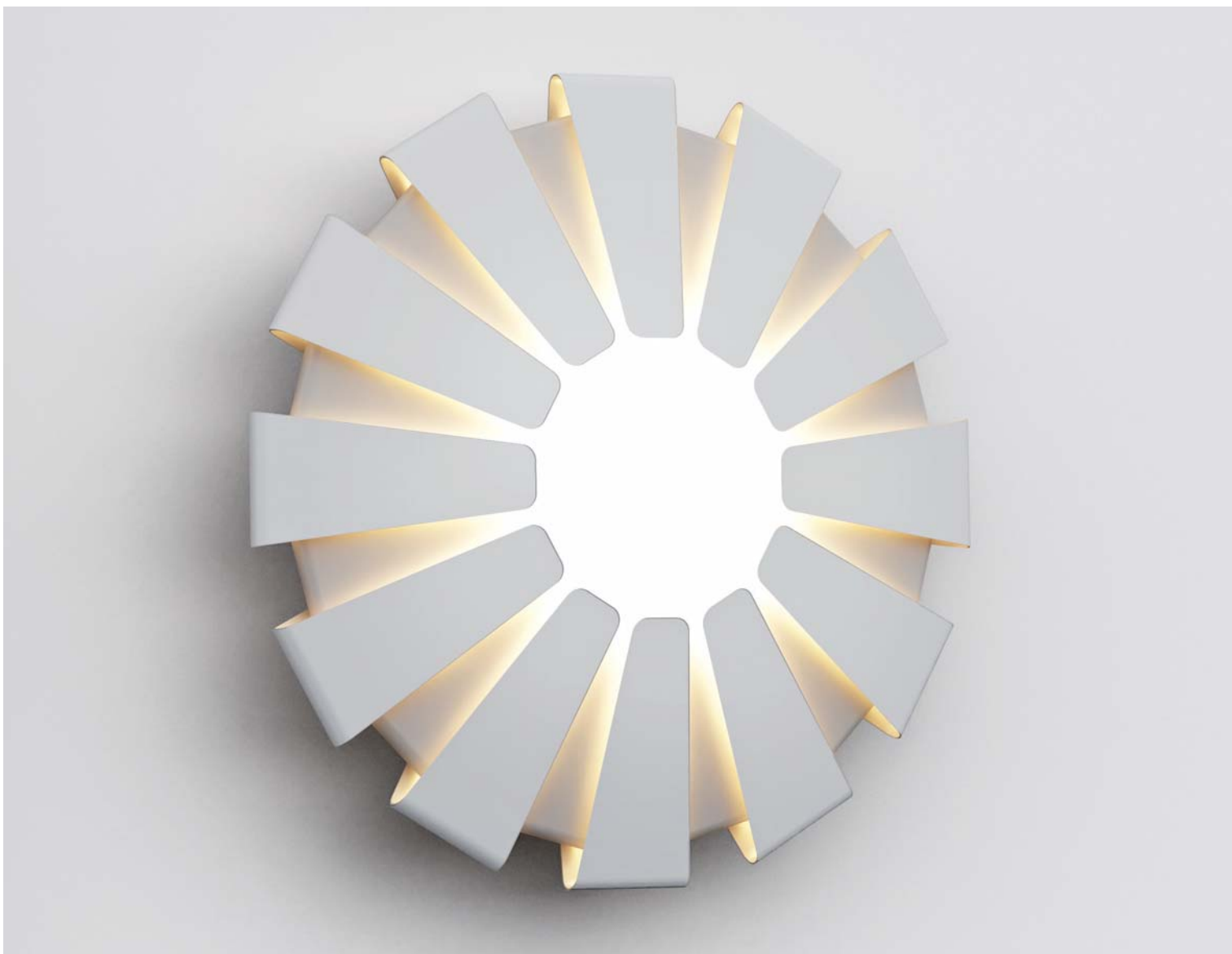

Alma

Lampada da soffitto o parete. Struttura costituita da parti in metallo verniciato bianco opaco che determinano un originale gioco di luce. Diffusore in policarbonato opale. Montatura in metallo verniciato bianco ral 9016. La versione RGB per missaggio di luci colorate è equipaggiata con LED smd Full Color, alimentatore elettronico e modulo per controllo ciclo colore incorporati. **Versione LED equipaggiata con led smd e alimentatore elettronico incorporato.**

Ceiling or wall lamp. Structure made in metal parts white matt painted that permit an original play of light. Diffusers made in opal polycarbonate. Frame made in white painted metal ral 9016. RGB version for coloured lights mixing is equipped with LED smd Full Color, electronic gear included to control colour cycle. **LED version equipped with smd led and electronic driver included.**

Lampe à plafond ou à mur. Structure réalisée en parties de métal vernie blanc opaque qui permettent un jeu de lumière original. Diffuseurs en polycarbonate opale. Monture réalisée en métal vernie blanc ral 9016. Version RGB pour mixage de lumières colorées équipée avec LED smd Full Color, ballast électronique incorporé pour contrôler le cycle des couleurs. **Version LED équipée avec led smd et ballast électronique incorporé.**

Lámpara de techo o pared. Estructura está hecha de piezas de metal pintado blanco opaco que determinan un original juego de luz. Difusors de policarbonato opale. Montadura de metal pintado blanco ral 9016. Versión RGB para mezclar las luces coloreadas es suministrado con LED smd Full Color, alimentador electrónico incorporado con módulo para el control del ciclo de color. **Version LED suministrada con led smd y alimentador electrónico incluido.**

Decken- oder Wandleuchte. Struktur aus mattweiß lackiertem Metall, die ein originelles Lichtspiel erzeugt. Diffusor aus opalem Polycarbonat. Fassung aus weiß lackiertem Metall ral 9016. Ausführung RGB zur Mischung bunter Lichter Ausführung zum LED smd Full Color, elektronisches Versorgungsgerät mit Modul zur Farbzykluskontrolle integriert. **Ausführung LED zum led smd und integriert Versorgungsgerät elektronisch.**

Alma 400

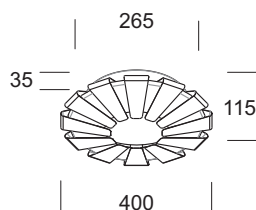

Articolo Item

Colore struttura Structure color

BI

W_{max}

LUMEN



LUMEN/W



Codice Code

E27	alma 400	11091	2x46	E27	1400	IP20	⊕	15	A
Led	alma 400 led-W	16651	15,3	led	2070	IP20	⊕	135	B
Led DM	alma 400 DM led-W	16671	15,3	led	2070	IP20	⊕	135	B
Led EM	alma 400 EM led-W	14001	15,3	led	2070	IP20	⊕	135	B
Led	alma 400 led-N	16661	15,3	led	2070	IP20	⊕	135	B
Led DM	alma 400 DM led-N	16681	15,3	led	2070	IP20	⊕	135	B
Led EM	alma 400 EM led-N	14011	15,3	led	2070	IP20	⊕	135	B
EL	alma 400 EL	18921	2x26	G24q-3	3600	IP20	⊕	69	A
DM	alma 400 DM	18931	2x26	G24q-3	3600	IP20	⊕	69	A
EM	alma 400 EM	14021	2x26	G24q-3	3600	IP20	⊕	69	A
DIG	alma 400 RGB DIG	14031	28	led RGB	1680	IP20	⊕	60	(nd)
DALI	alma 400 RGB DALI	14041	28	led RGB	1680	IP20	⊕	60	(nd)

Colore struttura Structure color

BI RAL 9016

Bianco opaco Matt white

Led Equipaggiata con led 3000K - Equipped with led 3000K

Led Equipaggiata con led 4000K - Equipped with led 4000K

Led DM DM Dimmerabile PUSH/DALI
Dimmable PUSH/DALI (info page 10)

Led EM EM Emergenza (SA) 1h di serie - 3h a richiesta
Emergency 1h standard - 3h on request

DIG DALI Apparecchio con sistema RGB.
Fitting with RGB system. (info page 10)

(nd) non disponibile - not available.

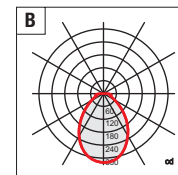
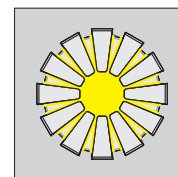
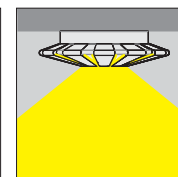
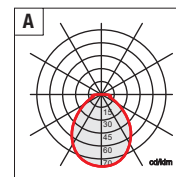

Alma 600

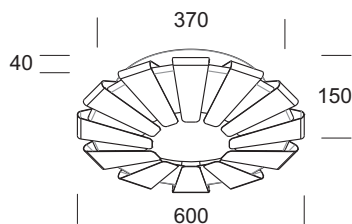

Colore struttura Structure color

Articolo Item	BI Codice Code	W _{max}		LUMEN		LUMEN/W	
alma 600	11101	3x46	E27	2100	IP20	15	A
alma 600 led-W	16691	21,7	led	2600	IP20	120	B
alma 600 DM led-W	16711	21,7	led	2600	IP20	120	B
alma 600 EM led-W	14051	21,7	led	2600	IP20	120	B
alma 600 led-N	16701	21,7	led	2600	IP20	120	B
alma 600 DM led-N	16721	21,7	led	2600	IP20	120	B
alma 600 EM led-N	14061	21,7	led	2600	IP20	120	B
alma 600 EL	18941	2x32(a)	GX24q-3	4800	IP20	75	A
alma 600 DM	18951	2x32	GX24q-3	4800	IP20	75	A
alma 600 EM	14071	2x32(a)	GX24q-3	4800	IP20	75	A
alma 600 RGB DIG	14081	28	led RGB	1680	IP20	60	(nd)
alma 600 RGB DALI	14091	28	led RGB	1680	IP20	60	(nd)

Colore struttura Structure color

RAL 9016
Bianco opaco *Matt white*

Equipaggiata con led 3000K - *Equipped with led 3000K*

Equipaggiata con led 4000K - *Equipped with led 4000K*

Dimmerabile PUSH/DALI
Dimmable PUSH/DALI (info page 10)

Emergenza (SA) 1h di serie – 3h a richiesta
Emergency 1h standard – 3h on request

Apparecchio con sistema RGB.
Fitting with RGB system. (info page 10)

(a) Equipaggiato con alimentatore multipotenza per l'utilizzo di lampade da 26W o 32W.
Equipped with multi-power ballast to use bulbs of 26W or 32W.

(nd) non disponibile – *not available.*

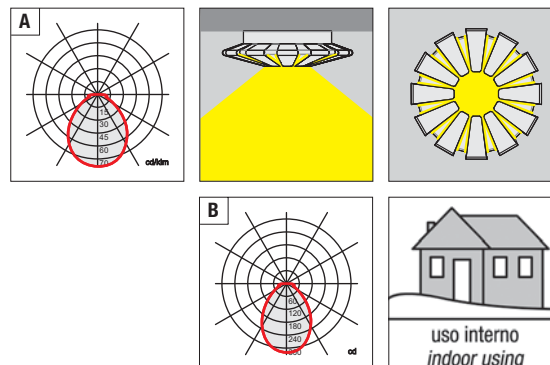

Regolo

Lampada da soffitto o parete. Diffusore in vetro soffiato opale satinato. Montatura in metallo verniciato bianco ral 9016. **Versione LED equipaggiata con led smd e alimentatore elettronico incorporato.**

Ceiling or wall lamp. Diffuser made in blown satin opal glass. Frame made in white painted metal ral 9016. **LED version equipped with smd led and electronic driver included.**

Lampe à plafond ou à mur. Diffuseur en verre soufflé opale satiné. Monture réalisée en métal vernie blanc ral 9016. **Version LED équipée avec led smd et ballast électronique incorporé.**

Lámpara de techo o pared. Difusor de vidrio soplado opal satinado. Montadura de metal pintado blanco ral 9016. **Version LED suministrada con led smd y alimentador electrónico incluido.**

Decken- oder Wandleuchte. Diffusor aus geblasenem Opalglas, satiniert. Fassung aus weiß lackiertem Metall Ral 9016. **Ausführung LED zum led smd und integriert Versorgungsgerät elektronisch.**



Regolo 250

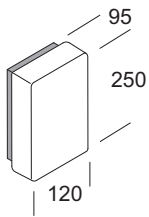

Colore vetro Glass color

Articolo Item	Colore vetro Glass color		W _{max}	Icona	LUMEN	Icona	LUMEN/W	Icona	
	OP	Codice Code							
E27 regolo 250		11131	1x46	E27	700	IP40	⊕	15	A
● Led regolo 250 led-W		15521	6,2	led	850	IP40	⊕	137	B
● Led regolo 250 led-N		15531	6,2	led	850	IP40	⊕	137	B
EL regolo 250 EL		19971	1x18	G24q-2	1200	IP40	⊕	67	A

Regolo 350

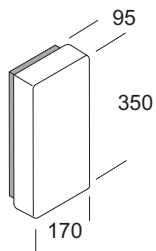

E27 regolo 350		11141	2x46	E27	1400	IP40	⊕	15	A
● Led regolo 350 led-W		15541	11,5	led	1560	IP40	⊕	136	B
● Led DM regolo 350 DM led-W		15561	11,5	led	1560	IP40	⊕	136	B
● Led EM regolo 350 EM led-W		14701	11,5	led	1560	IP40	⊕	136	B
● Led regolo 350 led-N		15551	11,5	led	1560	IP40	⊕	136	B
● Led DM regolo 350 DM led-N		15571	11,5	led	1560	IP40	⊕	136	B
● Led EM regolo 350 EM led-N		14711	11,5	led	1560	IP40	⊕	136	B
EL regolo 350 EL		19981	2x18	G24q-2	2400	IP40	⊕	67	A

Colore vetro Glass color

● Nuova versione New version

OP
Opale satinato *Satin opal*

Led Equipaggiata con led 3000K - *Equipped with led 3000K*

Led Equipaggiata con led 4000K - *Equipped with led 4000K*

Led DM **Led DM** Dimmerabile PUSH/DALI
Dimmable PUSH/DALI (info page10)

Led EM **Led EM** Emergenza (SA) 1h di serie – 3h a richiesta
Emergency 1h standard – 3h on request

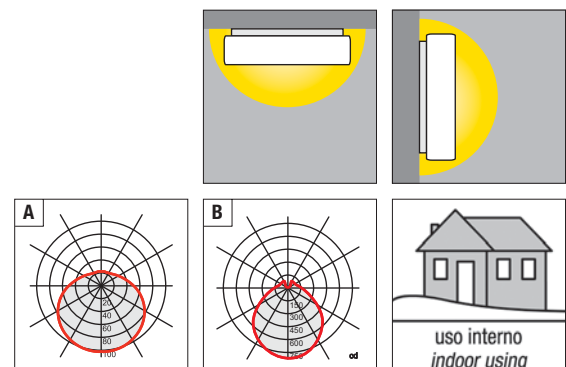



Quadro

Lampada da soffitto o parete. Diffusore in vetro soffiato opale triplex lucido con sistema di aggancio a baionetta. La base trasparente o colorata, in policarbonato autoestinguente, permette di creare, sulla parete, un alone colorato mantenendo il flusso di luce centrale bianco. Base KOMBI in metallo verniciato bianco ral 9016. Guarnizione in silicone per le versioni IP65. **Versione LED equipaggiata con led smd e alimentatore elettronico incorporato. Versioni LED24 per installazione in zona 1 (in prossimità di vasche o docce CEI 64-8/7 art.701.32) funzionanti con alimentatore remoto 24V non incluso e acquistabile separatamente.**

Ceiling or wall lamp. Diffuser made in blown shiny opal triplex glass with bayonet lock system. The transparent or coloured base, made in auto-extinguishing polycarbonate, permits to create, on the wall, a coloured ring leaving the central light in white. Base KOMBI made in white painted metal ral 9016. Silicon gasket for versions IP65. **LED version equipped with smd led and electronic driver included. LED24 versions suitable for installation in zone 1 (near a bathtub or shower CEI 64-8/7 art.701.32) working with 24V remote ballast not included and purchasable separately.**

Lampe à plafond ou à mur. Diffuseur en verre soufflé opale triplex brillant avec système d'accroche à baïonnette. La base transparente ou colorée, réalisée en polycarbonate auto-extinguible, permet de créer, sur le mur, un halo coloré conservant la lumière centrale blanche. Base KOMBI réalisée en métal vernie blanc ral 9016. Joint en silicone pour les versions IP65. **Version LED équipée avec led smd et ballast électronique incorporé. Versions LED24 pour installation in zone 1 (près d'une baignoire ou d'une douche CEI 64-8/7 art.701.32) fonctionnant avec ballast 24V à distance pas inclus et vendu séparément.**

Lámpara de techo o pared. Difusor de vidrio soplado opal triplex brillante con sistema de enganche a bayoneta. La base transparente o de colores, en policarbonato de autoextinción, permite crear, en la pared, un halo de colores manteniendo el flujo de luz central blanco. Base KOMBI en metal pintado blanco ral 9016. Junta de protección de silicona para las versiones y IP65. **Version LED suministrada con led smd y alimentador electronico incluido. Versiones LED24 para el uso en zona 1 (en las proximidades de las duchas o bañera CEI 64-8/7 art.701.32) usando alimentador 24V a distancia no incluido y que se vende separado.**

Decken- oder Wandleuchte. Diffusor aus geblasenem Triplex-Opalglas, glänzend, mit Bajonettssystem zur Befestigung. Die transparente oder farbige Basis, aus selbstlöschendem Polycarbonat, ermöglicht es, an der Wand einen farbigen Lichthof zu erzeugen, wobei der zentrale Lichtfluss weiß bleibt. Basis KOMBI aus weiß lackiertem Metall Ral 9016. Silikondichtung für die Ausführungen IP65. **Ausführung LED zum led smd und integriert Versorgungsgerät elektronisch. LED24 Versionen für den Einsatz in Zone 1 (Nähe Badewanne oder Duschen CEI 64-8/7 art.701.32) mit 24V Fernspeisung nicht inbegriffen und separat erhältlich.**



Quadro 250

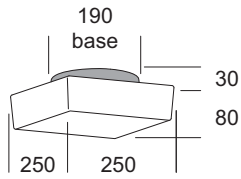

Articolo Item	Colore base Frame color				W _{max}	E27	LUMEN	IP	LUMEN/W	A
	BL	GI	RO	TR						
	Codice Code									
E27 quadro 250 IP	23385	23382	23383	23380	1x46	E27	700	IP65	15	A
● Led quadro 250 led-W	15405	15402	15403	15400	8,33	led	1090	IP65	131	C
● Led 24 quadro 250 led24-W	15425	15422	15423	15420	8,33	led 24V	1090	IP65	131	C
● Led DM quadro 250 DM led-W	15445	15442	15443	15440	8,33	led	1090	IP65	131	C
● Led quadro 250 led-N	15415	15412	15413	15410	8,33	led	1090	IP65	131	C
● Led 24 quadro 250 led24-N	15435	15432	15433	15430	8,33	led 24V	1090	IP65	131	C
● Led DM quadro 250 DM led-N	15455	15452	15453	15450	8,33	led	1090	IP65	131	C

Quadro 300

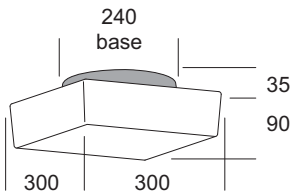

E27 quadro 300 IP	23395	23392	23393	23390	1x77	E27	1320	IP65	17	A
● Led quadro 300 led-W	15465	15462	15463	15460	10,5	led	1325	IP65	126	C
● Led 24 quadro 300 led24-W	15485	15482	15483	15480	10,5	led 24V	1325	IP65	126	C
● Led DM quadro 300 DM led-W	15505	15502	15503	15500	10,5	led	1325	IP65	126	C
● Led EM quadro 300 EM led-W	14685	14682	14683	14680	10,5	led	1325	IP65	126	C
● Led quadro 300 led-N	15475	15472	15473	15470	10,5	led	1325	IP65	126	C
● Led 24 quadro 300 led24-N	15495	15492	15493	15490	10,5	led 24V	1325	IP65	126	C
● Led DM quadro 300 DM led-N	15515	15512	15513	15510	10,5	led	1325	IP65	126	C
● Led EM quadro 300 EM led-N	14695	14692	14693	14690	10,5	led	1325	IP65	126	C
EL quadro 300 EL IP	28385	28382	28383	28380	1x26	G24q-3	1800	IP65	69	B
DM quadro 300 DM IP	28205	28202	28203	28200	1x26	G24q-3	1800	IP65	69	B
EM quadro 300 EM IP	10575	10572	10573	10570	1x18	G24q-2	1200	IP65	67	B
BI	Montatura in metallo verniciato bianco. Solo per installazione interna White painted metal frame. Only for indoor installation									
EM quadro 300 EM/26	10580	KOMBI Ø270xH60			1x26	G24q-3	1800	IP20	69	B

Colore base Frame color

● Nuova versione New version

BL RAL 5017 Blu Blue	GI RAL 1023 Giallo Yellow	RO RAL 3000 Rosso Red	TR Trasparente Transparent	BI RAL 9016 Bianco White
--------------------------------	-------------------------------------	---------------------------------	--------------------------------------	------------------------------------

Led Equipaggiata con led 3000K - Equipped with led 3000K

Led Equipaggiata con led 4000K - Equipped with led 4000K

Led 24 Installazione in zona 1 (in prossimità di vasche o docce CEI 64-8/7 art. 701.32) con alimentatore remoto 24V non incluso e acquistabile separatamente (info pag. 9)
Led 24 Installation in zone 1 (near a bathtub or shower CEI 64-8/7 art. 701.32) with 24V remote ballast not included and purchasable separately (info page 9)

Led DM **Led DM** **DM** Dimmerabile PUSH/DALI
Dimmable PUSH/DALI (info page 10)

Led EM **Led EM** **EM** Emergenza (SA) 1h di serie – 3h a richiesta
Emergency 1h standard – 3h on request

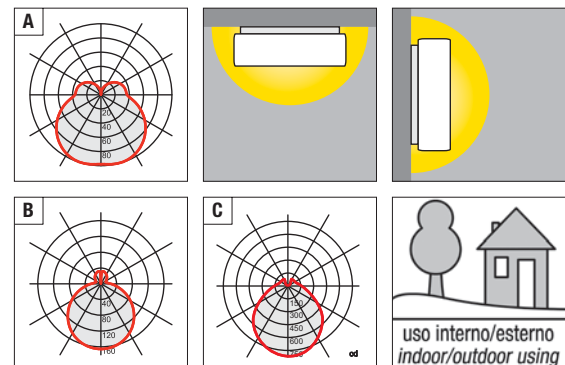



Disco

Lampada da soffitto o parete. Diffusore in vetro soffiato opale triplex lucido con sistema di aggancio a baionetta. La base trasparente o colorata, in policarbonato autoestinguente, permette di creare, sulla parete, un alone colorato mantenendo il flusso di luce centrale bianco. Base KOMBI in metallo verniciato bianco ral 9016. Guarnizione in silicone per le versioni IP65. **Versione LED equipaggiata con led smd e alimentatore elettronico incorporato. Versioni LED24 per installazione in zona 1 (in prossimità di vasche o docce CEI 64-8/7 art.701.32) funzionanti con alimentatore remoto 24V non incluso e acquistabile separatamente.**

Ceiling or wall lamp. Diffuser made in blown shiny opal triplex glass with bayonet lock system. The transparent or coloured base, made in auto-extinguishing polycarbonate, permits to create, on the wall, a coloured ring leaving the central light in white. Base KOMBI made in white painted metal ral 9016. Silicon gasket for versions IP65. **LED version equipped with smd led and electronic driver included. LED24 versions suitable for installation in zone 1 (near a bathtub or shower CEI 64-8/7 art.701.32) working with 24V remote ballast not included and purchasable separately.**

Lampe à plafond ou à mur. Diffuseur en verre soufflé opale triplex brillant avec système d'accroche à baïonnette. La base transparente ou colorée, réalisée en polycarbonate auto-extinguible, permet de créer, sur le mur, un halo coloré conservant la lumière centrale blanche. Base KOMBI réalisée en métal vernie blanc ral 9016. Joint en silicone pour les versions IP65. **Version LED équipée avec led smd et ballast électronique incorporé. Versions LED24 pour installation in zone 1 (près d'une baignoire ou d'une douche CEI 64-8/7 art.701.32) fonctionnant avec ballast 24V à distance pas inclus et vendu séparément.**

Lámpara de techo o pared. Difusor de vidrio soplado opal triplex brillante con sistema de enganche a bayoneta. La base transparente o de colores, en policarbonato de autoextinción, permite crear, en la pared, un halo de colores manteniendo el flujo de luz central blanco. Base KOMBI en metal pintado blanco ral 9016. Junta de protección de silicona para las versiones y IP65. **Version LED suministrada con led smd y alimentador electrónico incluido. Versiones LED24 para el uso en zona 1 (en las proximidades de las duchas o bañera CEI 64-8/7 art.701.32) usando alimentador 24V a distancia no incluido y que se vende separado.**

Decken- oder Wandleuchte. Diffusor aus geblasenem Triplex-Opalglas, glänzend, mit Bajonettsystem zur Befestigung. Die transparente oder farbige Basis, aus selbstlöschendem Polycarbonat, ermöglicht es, an der Wand einen farbigen Lichthof zu erzeugen, wobei der zentrale Lichtfluss weiß bleibt. Basis KOMBI aus weiß lackiertem Metall Ral 9016. Silikondichtung für die Ausführungen IP65. **Ausführung LED zum led smd und integriert Versorgungsgerät elektronisch. LED24 Versionen für den Einsatz in Zone 1 (Nähe Badewanne oder Duschen CEI 64-8/7 art.701.32) mit 24V Fernspeisung nicht inbegriffen und separat erhältlich.**

Disco 260

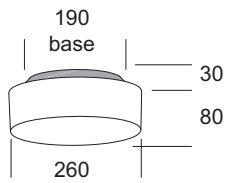

Articolo Item	Colore base Frame color				W _{max}	E27	LUMEN	IP65	LUMEN/W	A
	BL	GI	RO	TR						
	Codice Code									
E27 disco 260 IP	23175	23172	23173	23170	1x46	E27	730	IP65	15	A
● Led disco 260 led-W	17585	17582	17583	17580	8,33	led	1090	IP65	131	C
● Led 24 disco 260 led24-W	17605	17602	17603	17600	8,33	led 24V	1090	IP65	131	C
● Led DM disco 260 DM led-W	17625	17622	17623	17620	8,33	led	1090	IP65	131	C
● Led disco 260 led-N	17595	17592	17593	17590	8,33	led	1090	IP65	131	C
● Led 24 disco 260 led24-N	17615	17612	17613	17610	8,33	led 24V	1090	IP65	131	C
● Led DM disco 260 DM led-N	17635	17632	17633	17630	8,33	led	1090	IP65	131	C

Disco 310

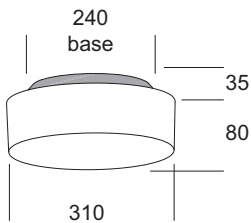

E27 disco 310 IP	23185	23182	23183	23180	1x77	E27	1320	IP65	17	A
● Led disco 310 led-W	17645	17642	17643	17640	10,5	led	1325	IP65	126	C
● Led 24 disco 310 led24-W	17665	17662	17663	17660	10,5	led 24V	1325	IP65	126	C
● Led DM disco 310 DM led-W	17685	17682	17683	17680	10,5	led	1325	IP65	126	C
● Led EM disco 310 EM led-W	14445	14442	14443	14440	10,5	led	1325	IP65	126	C
● Led disco 310 led-N	17655	17652	17653	17650	10,5	led	1325	IP65	126	C
● Led 24 disco 310 led24-N	17675	17672	17673	17670	10,5	led 24V	1325	IP65	126	C
● Led DM disco 310 DM led-N	17695	17692	17693	17690	10,5	led	1325	IP65	126	C
● Led EM disco 310 EM led-N	14455	14452	14453	14450	10,5	led	1325	IP65	126	C
EL disco 310 EL IP	28365	28362	28363	28360	1x26	G24q-3	1800	IP65	69	B
DM disco 310 DM IP	28165	28162	28163	28160	1x26	G24q-3	1800	IP65	69	B
EM disco 310 EM IP	10555	10552	10553	10550	1x18	G24q-2	1200	IP65	67	B
BI	Montatura in metallo verniciato bianco. Solo per installazione interna White painted metal frame. Only for indoor installation									
EM disco 310 EM/26	10560	KOMBI Ø270xH60			1x26	G24q-3	1800	IP20	69	B

Colore base Frame color

● Nuova versione New version

BL RAL 5017
Blu Blue

GI RAL 1023
Giallo Yellow

RO RAL 3000
Rosso Red

TR
Trasparente Transparent

BI RAL 9016
Bianco White

● Led Equipaggiata con led 3000K - Equipped with led 3000K

● Led Equipaggiata con led 4000K - Equipped with led 4000K

● Led 24 Installazione in zona 1 (in prossimità di vasche o docce CEI 64-8/7 art.701.32) con alimentatore remoto 24V non incluso e acquistabile separatamente (info pag. 9)
● Led 24 Installation in zone 1 (near a bathtub or shower CEI 64-8/7 art.701.32) with 24V remote ballast not included and purchasable separately (info page 9)

● Led DM ● Led DM ● DM Dimmerabile PUSH/DALI
Dimmable PUSH/DALI (info page 10)

● Led EM ● Led EM ● EM Emergenza (SA) 1h di serie - 3h a richiesta
Emergency 1h standard - 3h on request

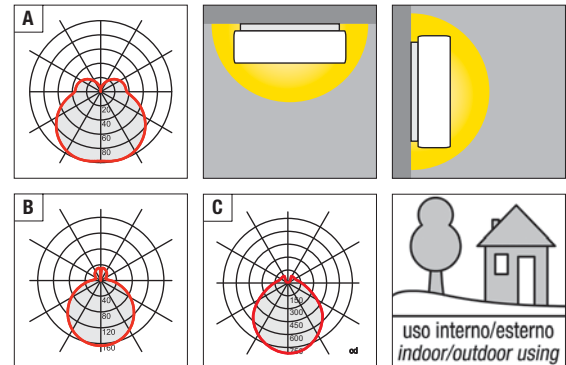



Bolla

Lampada da soffitto o parete. Diffusore in vetro soffiato trasparente e parte satinata con sistema di aggancio a baionetta. Base in policarbonato trasparente autoestinguente. Base KOMBI in metallo verniciato bianco ral 9016. Guarnizione in silicone per le versioni IP65.

Versione LED equipaggiata con led smd e alimentatore elettronico incorporato. Versioni LED24 per installazione in zona 1 (in prossimità di vasche o docce CEI 64-8/7 art.701.32) funzionanti con alimentatore remoto 24V non incluso e acquistabile separatamente.

Ceiling or wall lamp. Diffuser made in blown transparent glass with satin part glass and bayonet lock system. Base made in transparent auto-extinguishing polycarbonate. Base KOMBI made in white painted metal ral 9016. Silicon gasket for versions IP65.

LED version equipped with smd led and electronic driver included. LED24 versions suitable for installation in zone 1 (near a bathtub or shower CEI 64-8/7 art.701.32) working with 24V remote ballast not included and purchasable separately.

Lampe à plafond ou à mur. Diffuseur en verre soufflé transparent avec partie satiné et système d'accroche à baïonnette. Base réalisée en polycarbonate transparent auto-extinguible. Base KOMBI réalisée en métal vernie blanc ral 9016. Joint en silicone pour les versions IP65

Version LED équipée avec led smd et ballast électronique incorporé. Versions LED24 pour installation in zone 1 (près d'une baignoire ou d'une douche CEI 64-8/7 art.701.32) fonctionnant avec ballast 24V à distance pas inclus et vendu séparément.

Lámpara de techo o pared. Difusor de vidrio soplado transparente y sección satinada con sistema de enganche a bayoneta. Base en policarbonato transparente de autoextinción. Base KOMBI en metal pintado blanco ral 9016. Junta de protección de silicona para las versiones IP65.

Version LED suministrada con led smd y alimentador electrónico incluido. Versiones LED24 para el uso en zona 1 (en las proximidades de las duchas o bañera CEI 64-8/7 art.701.32) usando alimentador 24V a distancia no incluido y que se vende separado.

Decken- oder Wandleuchte. Diffusor aus geblasenem Transparentglas und satinierem Einsatz, mit Bajonettssystem zur Befestigung. Basis transparente aus selbstlöschendem Polycarbonat. Basis KOMBI aus weiß lackiertem Metall Ral 9016. Silikondichtung für die Ausführungen IP65.

Ausführung LED zum led smd und integriert Versorgungsgerät elektronisch. LED24 Versionen für den Einsatz in Zone 1 (Nähe Badewanne oder Duschen CEI 64-8/7 art.701.32) mit 24V Fernspeisung nicht inbegriffen und separat erhältlich.



14 applique interni/esterni
wall lights indoor/outdoor

150 plafoniere interni/esterni
ceiling bowls indoor/outdoor

248 testaletto
bed head units

258 sospensioni
suspensions

344 lampade
lamps

384 lampioni ed incassi
bollards & recessed lights

450 indice
index

Colore base Frame color

Bolla 260

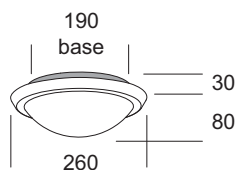

Articolo Item	TR	W _{max}		LUMEN		LUMEN/W	
	Codice Code						
E27 bolla 260 IP	23130	1x46	E27	700	IP65	15	A
● Led bolla 260 led-W	17360	8,33	led	1090	IP65	131	E
● Led 24 bolla 260 led24-W	17380	8,33	led 24V	1090	IP65	131	E
● Led DM bolla 260 DM led-W	17400	8,33	led	1090	IP65	131	E
● Led bolla 260 led-N	17370	8,33	led	1090	IP65	131	E
● Led 24 bolla 260 led24-N	17390	8,33	led 24V	1090	IP65	131	E
● Led DM bolla 260 DM led-N	17410	8,33	led	1090	IP65	131	E

Bolla 310

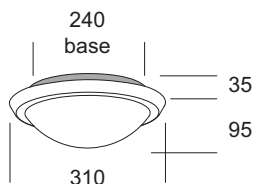

E27 bolla 310 IP	23140	1x77	E27	1320	IP65	17	A	
● Led bolla 310 led-W	17420	10,5	led	1325	IP65	126	E	
● Led 24 bolla 310 led24-W	17440	10,5	led 24V	1325	IP65	126	E	
● Led DM bolla 310 DM led-W	17460	10,5	led	1325	IP65	126	E	
● Led EM bolla 310 EM led-W	14380	10,5	led	1325	IP65	126	E	
● Led bolla 310 led-N	17430	10,5	led	1325	IP65	126	E	
● Led 24 bolla 310 led24-N	17450	10,5	led 24V	1325	IP65	126	E	
● Led DM bolla 310 DM led-N	17470	10,5	led	1325	IP65	126	E	
● Led EM bolla 310 EM led-N	14390	10,5	led	1325	IP65	126	E	
EL bolla 310 EL IP	28520	1x26	G24q-3	1800	IP65	69	B	
DM bolla 310 DM IP	18810	1x26	G24q-3	1800	IP65	69	B	
EM bolla 310 EM IP	10770	1x18	G24q-2	1200	IP65	67	B	
BI	Montatura in metallo verniciato bianco. Solo per installazione interna White painted metal frame. Only for indoor installation							
EM bolla 310 EM/26	10781	KOMBI Ø270xH60	1x26	G24q-3	1800	IP20	69	B

Colore base Frame color

● Nuova versione New version

TR
Trasparente TransparentBI RAL 9016
Bianco White

Led Equipaggiata con led 3000K - Equipped with led 3000K

Led Equipaggiata con led 4000K - Equipped with led 4000K

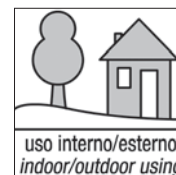
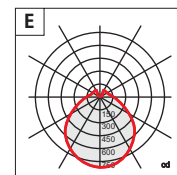
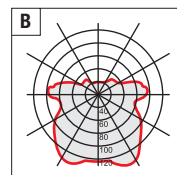
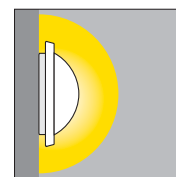
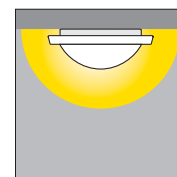
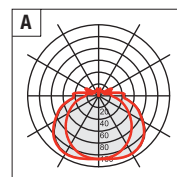
Led 24 Installazione in zona 1 (in prossimità di vasche o docce CEI 64-8/7 art. 701.32)
con alimentatore remoto 24V non incluso e acquistabile separatamente (info pag. 9)
Led 24 Installation in zone 1 (near a bathtub or shower CEI 64-8/7 art. 701.32)
with 24V remote ballast not included and purchasable separately (info page 9)Led DM Led DM DM Dimmerabile PUSH/DALI
Dimmable PUSH/DALI (info page 10)Led EM Led EM EM Emergenza (SA) 1h di serie - 3h a richiesta
Emergency 1h standard - 3h on requestuso interno/esterno
indoor/outdoor using

Bolla 370

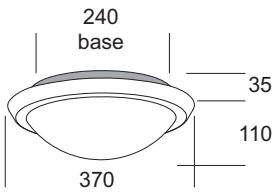

		Colore base <i>Frame color</i>								
Articolo <i>Item</i>	TR			W _{max}		LUMEN		LUMEN/W		
	Codice <i>Code</i>									
<input type="checkbox"/> E27	bolla 370 IP	23150		2x46	E27	1400	IP65	☐	15	C
● <input type="checkbox"/> Led	bolla 370 led-W	17480		15,5	led	1860	IP65	⊕	120	E
● <input type="checkbox"/> Led 24	bolla 370 led24-W	17500		15,5	led 24V	1860	IP65	⊕	120	E
● <input type="checkbox"/> Led DM	bolla 370 DM led-W	17520		15,5	led	1860	IP65	⊕	120	E
● <input type="checkbox"/> Led EM	bolla 370 EM led-W	14400		15,5	led	1860	IP65	⊕	120	E
● <input type="checkbox"/> Led	bolla 370 led-N	17490		15,5	led	1860	IP65	⊕	120	E
● <input type="checkbox"/> Led 24	bolla 370 led24-N	17510		15,5	led 24V	1860	IP65	⊕	120	E
● <input type="checkbox"/> Led DM	bolla 370 DM led-N	17530		15,5	led	1860	IP65	⊕	120	E
● <input type="checkbox"/> Led EM	bolla 370 EM led-N	14410		15,5	led	1860	IP65	⊕	120	E
<input type="checkbox"/> EL	bolla 370 EL IP	18050		2x18	G24q-2	2400	IP65	⊕	67	D
<input type="checkbox"/> DM	bolla 370 DM IP	18820		2x18	G24q-2	2400	IP65	⊕	67	D
<input type="checkbox"/> EM	bolla 370 EM IP	10790		1x26	G24q-3	1800	IP65	⊕	69	B
<input type="checkbox"/> BI	Montatura in metallo verniciato bianco. Solo per installazione interna White painted metal frame. Only for indoor installation									
<input type="checkbox"/> EM	bolla 370 EM/36	10691	KOMBI Ø370xH65	2x18	G24q-2	2400	IP20	⊕	67	D

Colore base *Frame color*

● Nuova versione *New version*

- TR
Trasparente *Transparent*
- BI RAL 9016
Bianco *White*

- Led Equipaggiata con led 3000K - *Equipped with led 3000K*
- Led Equipaggiata con led 4000K - *Equipped with led 4000K*
- Led 24 Installazione in zona 1 (in prossimità di vasche o docce CEI 64-8/7 art. 701.32) con alimentatore remoto 24V non incluso e acquistabile separatamente (info pag. 9)
Installation in zone 1 (near a bathtub or shower CEI 64-8/7 art. 701.32) with 24V remote ballast not included and purchasable separately (info page 9)
- Led DM Led DM DM Dimmerabile PUSH/DALI
Dimmable PUSH/DALI (info page 10)
- Led EM Led EM EM Emergenza (SA) 1h di serie – 3h a richiesta
Emergency 1h standard – 3h on request

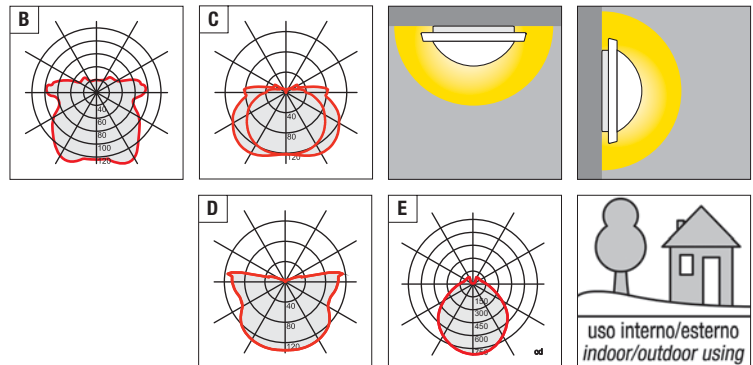

14 appliche interni/esterni
wall lights indoor/outdoor

150 plafoniere interni/esterni
ceiling bowls indoor/outdoor

248 testate
bed head units

258 sospensioni
suspensions

344 lampade
lamps

384 lampioni ed incassi
bollards & recessed lights

450 indice
index



Omega

Lampada da soffitto o parete. Diffusore in vetro satinato. Montatura in tecnopolimero bianco. Fascia in metallo verniciato o con finitura galvanica.

Versione LED equipaggiata con led smd e alimentatore elettronico incorporato.

Ceiling or wall lamp. Diffuser made in satin glass. Base made in white techno-polymer. Ring made in painted metal or with galvanic finish.

LED version equipped with smd led and electronic driver included.

Lampe à plafond ou à mur. Diffuseur en verre satiné. Base réalisée en tecno-polymère blanc. Anneau réalisé en métal vernie ou avec finition galvanique.

Version LED équipée avec led smd et ballast électronique incorporé.

Lámpara de techo o pared. Difusor de vidrio satinado. Montadura en tecnopolímero blanco. Faja de metal pintado o con acabado galvanico.

Version LED suministrada con led smd y alimentador electronico incluido.

Decken- oder Wandleuchte. Diffusor aus satiniertem Glas. Fassung aus weißem Technopolymer. Metallband lackiert oder mit galvanischem Finish.

Ausführung LED zum led smd und integriert Versorgungsgesät elektronisch.

Omega 300

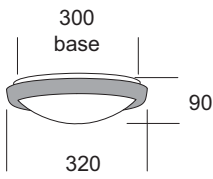

Articolo Item	Colore fascia Ring color			W _{max}	E27	LUMEN	IP20	LUMEN/W	A
	BI	NE	CR						
<input type="checkbox"/> E27 omega 300	11401	11407	11406	1x77	E27	1320	IP20	17	A
● <input type="checkbox"/> Led omega 300 led-W	15341	15347	15346	8,33	led	1090	IP20	131	C
● <input type="checkbox"/> Led omega 300 led-N	15351	15357	15356	8,33	led	1090	IP20	131	C

Omega 400

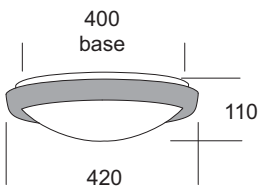

<input type="checkbox"/> E27 omega 400	11411	11417	11416	2x46	E27	1400	IP20	15	B
● <input type="checkbox"/> Led omega 400 led-W	15361	15367	15366	15,5	led	1860	IP20	120	C
● <input type="checkbox"/> Led EM omega 400 EM led-W	14641	14647	14646	15,5	led	1860	IP20	120	C
● <input type="checkbox"/> Led omega 400 led-N	15371	15377	15376	15,5	led	1860	IP20	120	C
● <input type="checkbox"/> Led EM omega 400 EM led-N	14651	14657	14656	15,5	led	1860	IP20	120	C
<input type="checkbox"/> EL omega 400 EL	18731	18737	18736	2x18	G24q-2	2400	IP20	67	B
<input type="checkbox"/> EM omega 400 EM	10871	10877	10876	2x18	G24q-2	2400	IP20	67	B

Omega 500

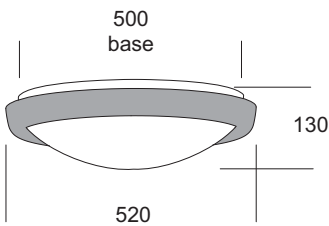

<input type="checkbox"/> E27 omega 500	11421	11427	11426	2x77	E27	2640	IP20	17	B
● <input type="checkbox"/> Led omega 500 led-W	15381	15387	15386	15,3	led	2070	IP20	135	C
● <input type="checkbox"/> Led EM omega 500 EM led-W	14661	14667	14666	15,3	led	2070	IP20	135	C
● <input type="checkbox"/> Led omega 500 led-N	15391	15397	15396	15,3	led	2070	IP20	135	C
● <input type="checkbox"/> Led EM omega 500 EM led-N	14671	14677	14676	15,3	led	2070	IP20	135	C
<input type="checkbox"/> EL omega 500 EL	18741	18747	18746	2x26	G24q-3	3600	IP20	69	B
<input type="checkbox"/> EM omega 500 EM	10881	10887	10886	2x26	G24q-3	3600	IP20	69	B

Colore fascia Ring color

<input type="checkbox"/> BI RAL 9016 Bianco opaco <i>Matt white</i>	<input type="checkbox"/> NE RAL 9005 Nero opaco <i>Matt black</i>	<input type="checkbox"/> CR Cromato <i>Chrome</i>
---	---	--

● Nuova versione *New version*

- Led Equipaggiata con led 3000K - *Equipped with led 3000K*
- Led Equipaggiata con led 4000K - *Equipped with led 4000K*
- Led EM Led EM EM Emergenza (SA) 1h di serie – 3h a richiesta
Emergency 1h standard – 3h on request

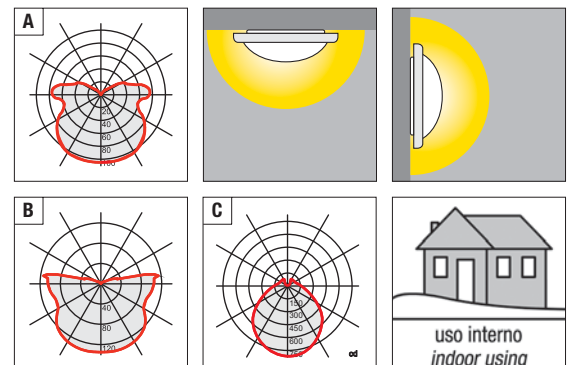



Lella

Lampada da soffitto o parete. Diffusore in policarbonato opale. Base in policarbonato bianco. Anello in policarbonato verniciato bianco opaco ral 9016, alluminio ral 9006 o colore ruggine. **Versione LED equipaggiata con led smd alimentati a tensione di rete AC. Versioni 250S e 300S equipaggiate con led smd e alimentatore elettronico incorporato.**

Ceiling or wall lamp. Diffuser made in opal polycarbonate. Base made in white polycarbonate. Ring made in polycarbonate painted matt white ral 9016, aluminium ral 9006 or rust color. **LED version equipped with smd LED driven directly to AC mains voltage. Versions 250S and 300S equipped with smd led and electronic driver included.**

Lampe à plafond ou à mur. Diffuseur en polycarbonate opale. Base réalisée en polycarbonate blanc. Anneau en polycarbonate verni blanc opaque ral 9016, aluminium ral 9006 ou couleur rouille. **Version LED équipée avec led smd branché directement au Courant Primaire AC. Versions 250S et 300S équipées avec led smd et ballast électronique incorporé.**

Lámpara de techo o pared. Difusor de policarbonato opale. Base en policarbonato blanco. Anillo de policarbonato pintado blanco opaco ral 9016, aluminio ral 9006 o color óxido. **Versiones LED suministradas con led smd conectados directamente a la corriente primaria AC. Versiones 250S y 300S suministradas con led smd y alimentador electrónico incluido.**

Decken- oder Wandleuchte. Diffusor aus opalem Polycarbonat. Basis aus weißem Polycarbonat. Ring aus Polycarbonat lackiert matt weiß Ral 9016, Aluminium Ral 9006 oder lackiert Rost. **Version LED ausgestattet mit led smd mit Strom um AC Netzspannung. Versionen 250S und 300S zum led smd und integriert Versorgungsgerät elektronisch.**

Lella 250

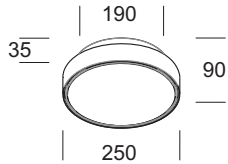

Articolo Item	Colore fascia Ring color			W _{max}	LUMEN	LUMEN/W	LUMEN/W	LUMEN/W	LUMEN/W	
	AL	BI	RU							
	Codice Code									
E27 lella 250	11809	11801	11808	1x18 FBT	E27	1140	IP65	⊕	63	A
Led lella 250 led-W	15009	15001	15008	10(a)	led	1200	IP65	⊕	120	B
lella 250S led-W	16619	16611	16618	15,5	led	1860	IP65	⊕	120	B
Led lella 250 led-N	15019	15011	15018	10(a)	led	1200	IP65	⊕	120	B
lella 250S led-N	16629	16621	16628	15,5	led	1860	IP65	⊕	120	B
EL lella 250 EL	19959	19951	19958	1x18	G24q-2	1200	IP65	⊕	67	A

Lella 300

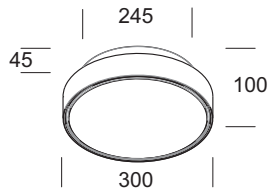

E27 lella 300	11819	11811	11818	1x23 FBT	E27	1500	IP65	⊕	65	A
Led lella 300 led-W	15029	15021	15028	17(a)	led	1590	IP65	⊕	94	B
lella 300S led-W	16739	16731	16738	15,3	led	2070	IP65	⊕	135	B
Led EM lella 300S EM led-W	14549	14541	14548	15,3	led	2070	IP65	⊕	135	B
Led lella 300 led-N	15039	15031	15038	17(a)	led	1590	IP65	⊕	94	B
lella 300S led-N	16749	16741	16748	15,3	led	2070	IP65	⊕	135	B
Led EM lella 300S EM led-N	14559	14551	14558	15,3	led	2070	IP65	⊕	135	B
EL lella 300 EL	19969	19961	19968	1x26	G24q-3	1800	IP65	⊕	69	A
EM lella 300 EM	10969	10961	10968	1x26	G24q-3	1800	IP65	⊕	69	A

Colore fascia Ring color

AL RAL 9006
Alluminio Aluminium

BI RAL 9016
Bianco opaco Matt white

RU
Ruggine Rust

Led Equipaggiata con led 3000K - Equipped with led 3000K

Led Equipaggiata con led 4000K - Equipped with led 4000K

Led EM Led EM EM Emergenza (SA) 1h di serie – 3h a richiesta
Emergency 1h standard – 3h on request

(a) Compatibile con dimmer a taglio di fase (TRIAC)
Compatible with phase cut dimmer (TRIAC)

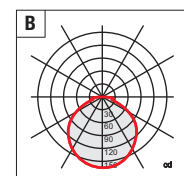
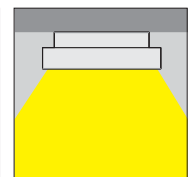
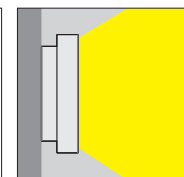
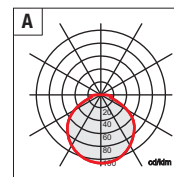

uso interno/esterno
indoor/outdoor using



Ring

Lampada da soffitto o parete. Diffusore in policarbonato opale. Struttura in pressofusione di alluminio, verniciatura in polvere poliestere con trattamento di fosfatazione. Viti in acciaio inox. Guarnizioni in silicone. **Versione LED equipaggiata con led smd e alimentatore elettronico incorporato.**

Ceiling or wall lamp. Diffuser made in opal polycarbonate. Structure made in die casting aluminium with Polyester paint and phosphate treatment. Inox steel screws. Gasket made in silicone rubber. **LED version equipped with smd led and electronic driver included.**

Lampe à plafond ou à mur. Diffuseur en polycarbonate opale. Structure réalisée en fonte d'aluminium. Vernis polyester traitement de phosphatation. Vis en acier inox. Joint en gomme de silicone. **Versión LED équipée avec led smd et ballast électronique incorporé.**

Lámpara de techo o pared. Difusor de policarbonato opal. Estructura en fundición a presión de aluminio, pintura en polvo poliéster con tratamiento de fosfatación. Tornillos de acero inoxidable. Junta de protección de silicona. **Versión LED suministrada con led smd y alimentador electrónico incluido.**

Decken- oder Wandleuchte. Diffusor aus opalem Polycarbonat. Struktur aus Aludruckguss, Lackierung aus Polyesterpulver mit Phosphatierung. Schrauben aus Edelstahl. Silikondichtungen. **Ausführung LED zum led smd und integriert Versorgungsgerät elektronisch.**

Ring 280

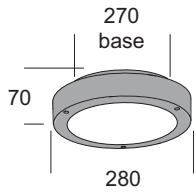

Articolo Item	Colore struttura Structure color				W _{max}	Icona	LUMEN	Icona	LUMEN/W	Icona
	AT	BI	GR	RU						
	Codice Code									
● Led ring 280 led-W	55717	55711	55716	55718	10,5	led	1325	IP65	⊕	126 D
● Led ring 280 led-N	55727	55721	55726	55728	10,5	led	1325	IP65	⊕	126 D
EL ring 280 EL	58397	58391	58396	58398	1x18	G24q-2	1200	IP65	⊕	67 A

Ring 350

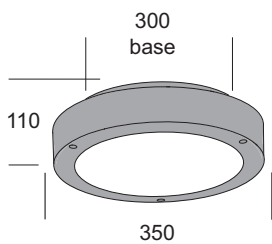

E27 ring 350	51167	51161	51166	51168	1x77	E27	1320	IP65	⊕	17 B
● Led ring 350 led-W	55737	55731	55736	55738	15,3	led	2070	IP65	⊕	135 D
● Led EM ring 350 EM led-W	50047	50041	50046	50048	15,3	led	2070	IP65	⊕	135 D
● Led ring 350 led-N	55747	55741	55746	55748	15,3	led	2070	IP65	⊕	135 D
● Led EM ring 350 EM led-N	50057	50051	50056	50058	15,3	led	2070	IP65	⊕	135 D
EL ring 350 EL	58407	58401	58406	58408	2x26	G24q-3	3600	IP65	⊕	69 C

Colore struttura Structure color

AT RAL 7016
Antracite gofrato Embossed anthracite

BI RAL 9016
Bianco gofrato Embossed white

GR RAL 9006
Grigio gofrato Embossed grey

● **RU**
Ruggine Rust

Led Equipaggiata con led 3000K - Equipped with led 3000K

Led Equipaggiata con led 4000K - Equipped with led 4000K

Led EM **Led EM** Emergenza (SA) 1h di serie - 3h a richiesta
Emergency 1h standard - 3h on request

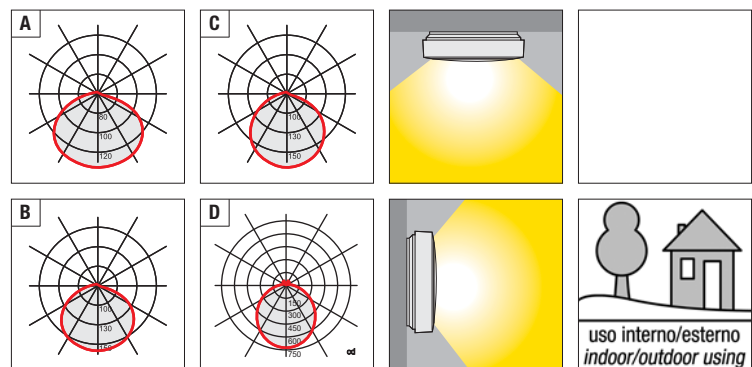

uso interno/esterno
indoor/outdoor using



Queen

Lampada da soffitto o parete. Diffusore in policarbonato opale. Struttura in pressofusione di alluminio, verniciatura in polvere poliesteri con trattamento di fosfatazione. Viti in acciaio inox. Guarnizioni in gomma ai polimeri. **Versione LED equipaggiata con led smd e alimentatore elettronico incorporato.**

Ceiling or wall lamp. Diffuser made in opal polycarbonate. Structure made in die casting aluminium with polyester paint and phosphate treatment. Inox steel screws. Gasket made in rubber. **LED version equipped with smd led and electronic driver included.**

Lampe à plafond ou à mur. Diffuseur en polycarbonate opale. Structure réalisée en fonte d'aluminium. Vernis polyester et traitement de phosphatation. Vis en acier inox. Joint en gomme. **Version LED équipée avec led smd et ballast électronique incorporé.**

Lámpara de techo o pared. Difusor de policarbonato opal. Estructura en fundición a presión de aluminio, pintura en polvo poliéster con tratamiento de fosfatación. Tornillos de acero inoxidable. Junta de protección de goma. **Version LED suministrada con led smd y alimentador electrónico incluido.**

Decken- oder Wandleuchte. Diffusor aus opalem Polycarbonat. Struktur aus Aludruckguss, Lackierung aus Polyester Pulver mit Phosphatierung. Schrauben aus Edelstahl. Dichtungen aus Polymergummi. **Ausführung LED zum led smd und integriert Versorgungsgerät elektronisch.**

Queen

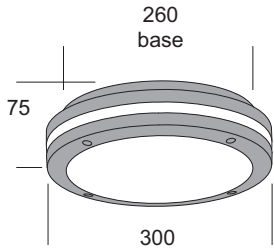

Colore struttura Structure color

Articolo Item

AT

GR

RU

W_{max}



LUMEN



LUMEN/W



Codice Code

●	E27	queen	51237	51236	51238	2x20 FBT	E27	2400	IP54	⊕	60	A
●	Led	queen led-W	55697	55696	55698	15,3	led	2070	IP54	⊕	135	B
●	Led EM	queen EM led-W	50027	50026	50028	15,3	led	2070	IP54	⊕	135	B
●	Led	queen led-N	55707	55706	55708	15,3	led	2070	IP54	⊕	135	B
●	Led EM	queen EM led-N	50037	50036	50038	15,3	led	2070	IP54	⊕	135	B
●	EL	queen EL	58387	58386	58388	2x18	G24q-2	2400	IP54	⊕	67	A



Colore struttura Structure color

● Nuova versione New version

AT RAL 7016
Antracite gofrato Embossed anthracite

GR RAL 9006
Grigio gofrato Embossed grey

● RU
Ruggine Rust

Led Equipaggiata con led 3000K - Equipped with led 3000K

Led Equipaggiata con led 4000K - Equipped with led 4000K

Led EM Led EM Emergenza (SA) 1h di serie – 3h a richiesta
Emergency 1h standard – 3h on request

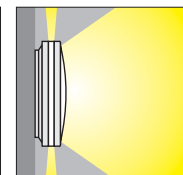
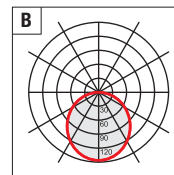
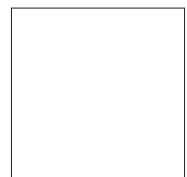
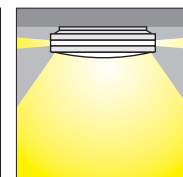
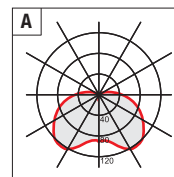



King

Lampada da soffitto o parete. Diffusore in policarbonato opale. Struttura in pressofusione di alluminio, verniciatura in polvere poliestere con trattamento di fosfatazione. Viti in acciaio inox. Guarnizioni in gomma ai polimeri. **Versione LED equipaggiata con led smd e alimentatore elettronico incorporato.**

Ceiling or wall lamp. Diffuser made in opal polycarbonate. Structure made in die casting aluminium with polyester paint and phosphate treatment. Inox steel screws. Gasket made in rubber. **LED version equipped with smd led and electronic driver included.**

Lampe à plafond ou à mur. Diffuseur en polycarbonate opale. Structure réalisée en fonte d'aluminium. Vernis polyester et traitement de phosphatation. Vis en acier inox. Joint en gomme. **Version LED équipée avec led smd et ballast électronique incorporé.**

Lámpara de techo o pared. Difusor de policarbonato opal. Estructura en fundición a presión de aluminio, pintura en polvo poliéster con tratamiento de fosfatación. Tornillos de acero inoxidable. Junta de protección de goma. **Version LED suministrada con led smd y alimentador electrónico incluido.**

Decken- oder Wandleuchte. Diffusor aus opalem Polycarbonat. Struktur aus Aludruckguss, Lackierung aus Polyester Pulver mit Phosphatierung. Schrauben aus Edelstahl. Dichtungen aus Polymergummi. **Ausführung LED zum led smd und integriert Versorgungsgerät elektronisch.**

King

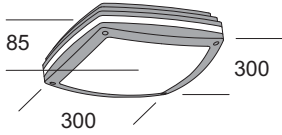

Colore struttura Structure color

Articolo Item

AT

GR

RU

W_{max}



LUMEN



LUMEN/W



Codice Code

●	E27	king	51227	51226	51228	2x20 FBT	E27	2400	IP54	⊕	60	A
●	Led	king led-W	55677	55676	55678	15,3	led	2070	IP54	⊕	135	B
●	Led EM	king EM led-W	50007	50006	50008	15,3	led	2070	IP54	⊕	135	B
●	Led	king led-N	55687	55686	55688	15,3	led	2070	IP54	⊕	135	B
●	Led EM	king EM led-N	50017	50016	50018	15,3	led	2070	IP54	⊕	135	B
	EL	king EL	58367	58366	58368	2x18	G24q-2	2400	IP54	⊕	67	A

Colore struttura Structure color

● Nuova versione New version

AT **RAL 7016**
Antracite gofrato Embossed anthracite

GR **RAL 9006**
Grigio gofrato Embossed grey

● RU
Ruggine Rust

Led Equipaggiata con led 3000K - Equipped with led 3000K

Led Equipaggiata con led 4000K - Equipped with led 4000K

Led EM Led EM Emergenza (SA) 1h di serie – 3h a richiesta
Emergency 1h standard – 3h on request

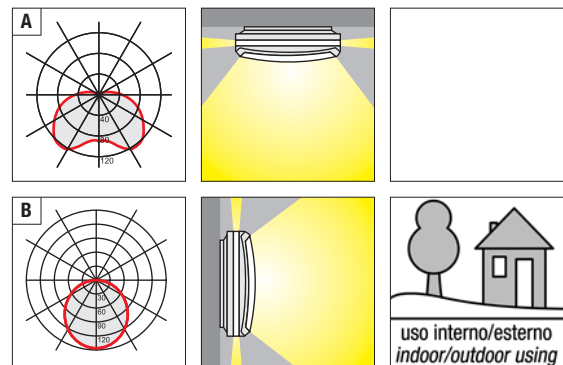

Testaletto - *Bed head units*

NEW 



Smart 250

NEW 



Smart 1 250





Fly 254

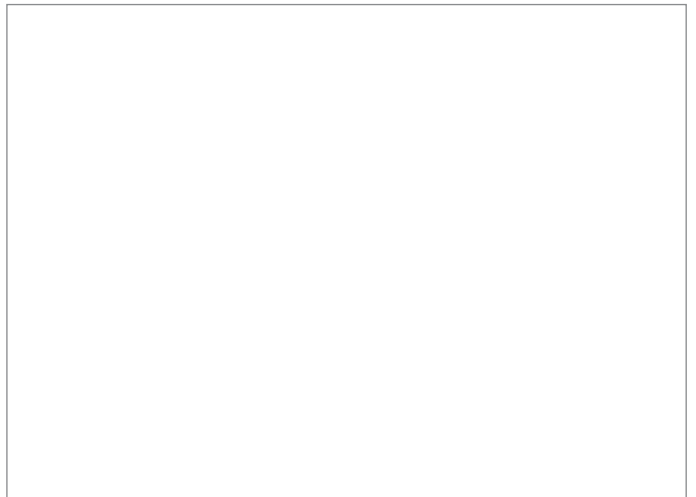

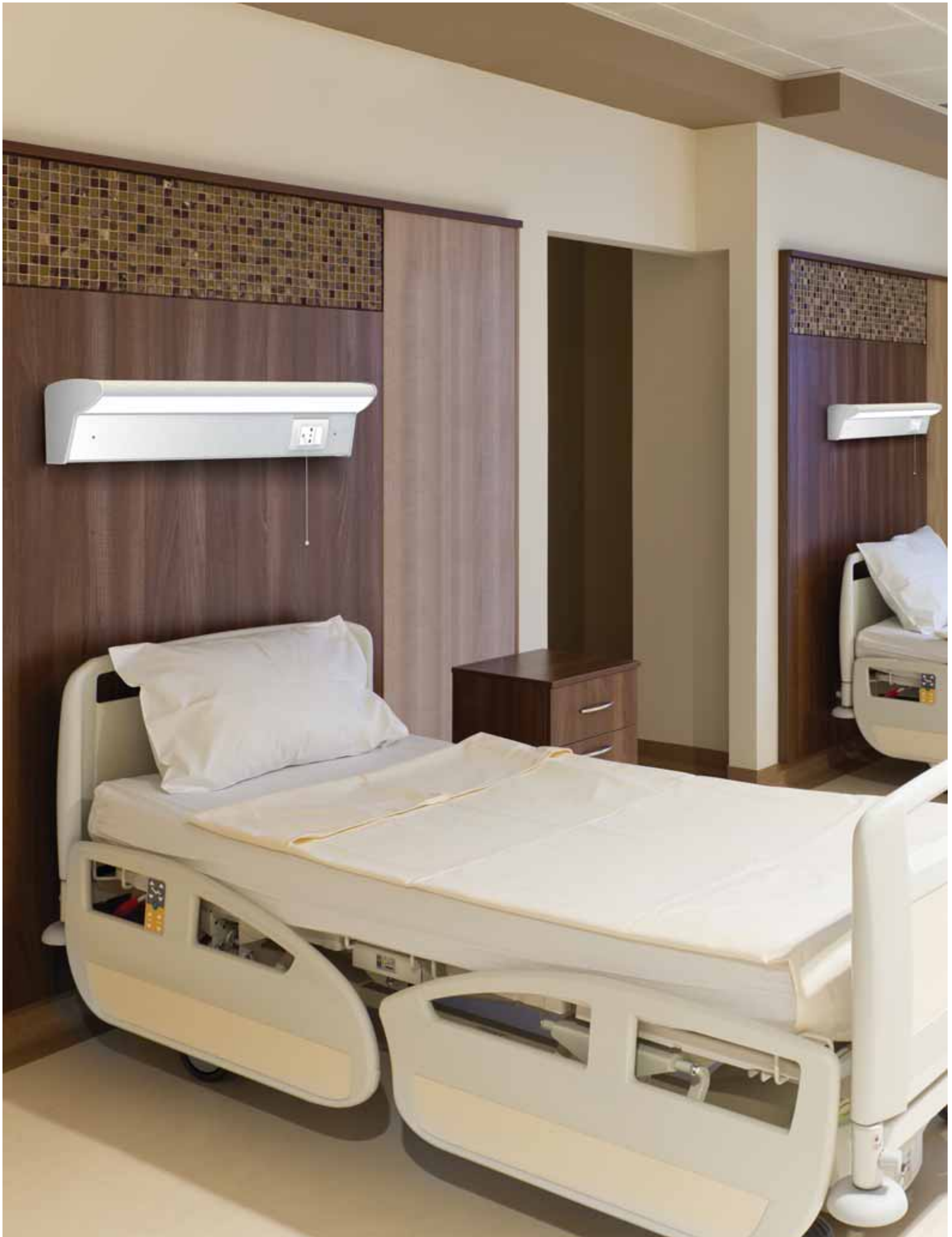



Smart



Smart 1

Smart

Apparecchio progettato per Case di Riposo e Assistenza per gli Anziani. Diffusore in policarbonato colore anice. Struttura in alluminio estruso con particolari in policarbonato, verniciatura in polvere poliestere con trattamento di fosfatazione. **Versione SMART1 progettato per Ospedali** con canale predisposto per alloggiamento da 1 a 3 tubi gas medicali; conforme alle normative EN60601-1, EN ISO 11197:2009, direttiva 93/42/CEE e ss.mm.ii., classe IIB.

Fitting realized for Care Homes and Residential Care Homes. Diffuser made in polycarbonate colour anise. Structure made in extruded aluminium and polycarbonate parts. Polyester paint with phosphate treatment. **Version SMART1 realized for Hospitals** equipped with channel designed to install from 1 to 3 medical gas tubes; compliant with standard EN60601-1, EN ISO 11197:2009, directive 93/42/CEE, classe IIB.

Appareil réalisé pour Maison de santé et Maisons de retraite. Diffuseur en polycarbonate couleur anis. Structure réalisée en extrusion d'aluminium avec parties en polycarbonate. Vernis polyester et traitement de phosphatation. **Version SMART1 réalisé pour Hôpitaux** équipé avec canal pour le logement 1 à 3 tubes des gaz médicaux : conforme aux normes EN60601-1, EN ISO 11197:2009, directive 93/42/CEE, classe IIB.

Aparato diseñado para Residencias de Ancianos y Asistencia de Ancianos. Difusor de policarbonato color anís. Estructura de aluminio extrudido con detalles de policarbonato, pintura en polvo poliéster con tratamiento de fosfatación. **Versión SMART1 diseñado para Hospitales** suministrada con canal para la instalación de 1 a 3 tubos de gases medicinales; conformidad con la normativa EN60601-1, EN ISO 11197:2009, directiva 93/42/CEE, classe IIB.

Gerät für Alters- und Pflegeheime. Diffusor aus anisfarbenem Polycarbonat. Struktur aus Aluminium extrusion mit Einzelteilen aus Polycarbonat, Lackierung aus Polyesterpulver mit Phosphatierung. **SMART1 Version gerät für Hospitals** mit dem Kanal für die Installation von Rohren 1-3 medizinischer Gase; Vorschriften EN60601-1, EN ISO 11197:2009, Direktive 93/42/CEE, classe IIB.

Smart 600.1

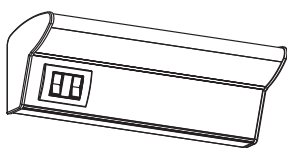

Smart 600.2

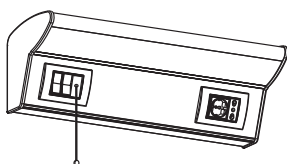

Smart 900.1

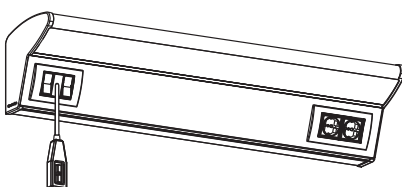

Smart 900.2

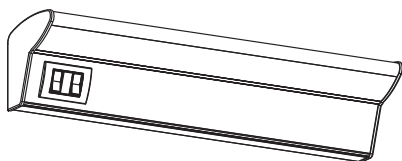

Smart 900.3

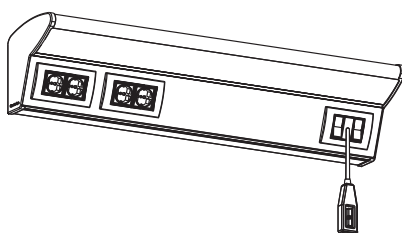

Smart 1200.1

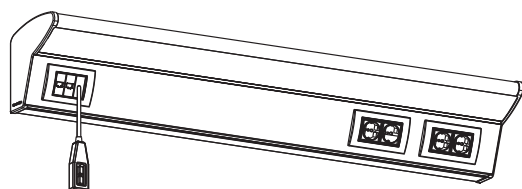

Testaletto per luce diretta e indiretta con accensione separata.

Possibilità di alloggiare la luce notturna sulla parte posteriore dell'apparecchio.

La versatilità del sistema permette di variare la lunghezza della struttura secondo le sorgenti luminose installate:

- TC-L 18-24-36-55W - T5 24-39-54W - LED

Gli accessori di comando, le prese elettriche e la finitura esterna possono cambiare a richiesta del cliente.

La progettazione e il preventivo vengono eseguiti per ogni singola composizione.

Bed head unit for direct and indirect light with separate lighting-up

Possibility to install the night light on the back of the fitting.

The system versatility allows to modify the length of the body according the light sources installed:

- TC-L 18-24-36-55W - T5 24-39-54W - LED

Control accessories, sockets and outside finish can change, based on client request.

Project and estimated cost are performed on every single version request.

Module tête de lit avec lumière directe et indirecte, avec allumage séparé.

Possibilité de commander la lumière de nuit sur la partie arrière de l'appareil.

La modularité de ce système permet aussi de modifier la longueur du corps suivant les sources utilisées:

- TC-L 18-24-36-55W - T5 24-39-54W - LED

Les accessoires de commande électrique, les prises et la finition extérieure peuvent changer selon la demande du client

Le projet et le devis seront réalisés selon chaque composition particulière.

Dispositivo para cabeza de cama para luz directa e indirecta con encendido separado.

Posibilidad de colocar la luz nocturna en la parte posterior del aparato.

La versatilidad del sistema permite variar la longitud de la estructura según las fuentes luminosas instaladas:

- TC-L 18-24-36-55W - T5 24-39-54W - LED

Los accesorios de mando, las tomas eléctricas y el acabado externo pueden cambiar a petición del cliente.

El proyecto y el presupuesto se hacen para cada composición.

Leuchte für direktes und indirektes Licht mit getrennter Einschaltvorrichtung.

Das Nachtlicht kann bei Bedarf auf der Rückseite des Geräts installiert werden.

Das vielseitig anwendbare System ermöglicht es die Länge der Struktur an die Art der installierten Lichtquelle anzupassen:

- TC-L 18-24-36-55W - T5 24-39-54W - LED

Die Steuerung, die elektrischen Anschlüsse und die externe Fertigung können auf die Bedürfnisse des Kunden abgestimmt werden.

Planung und Kostenvoranschlag werden spezifisch für jedes einzelne Projekt ausgearbeitet.

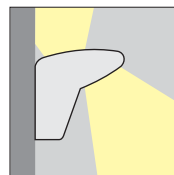



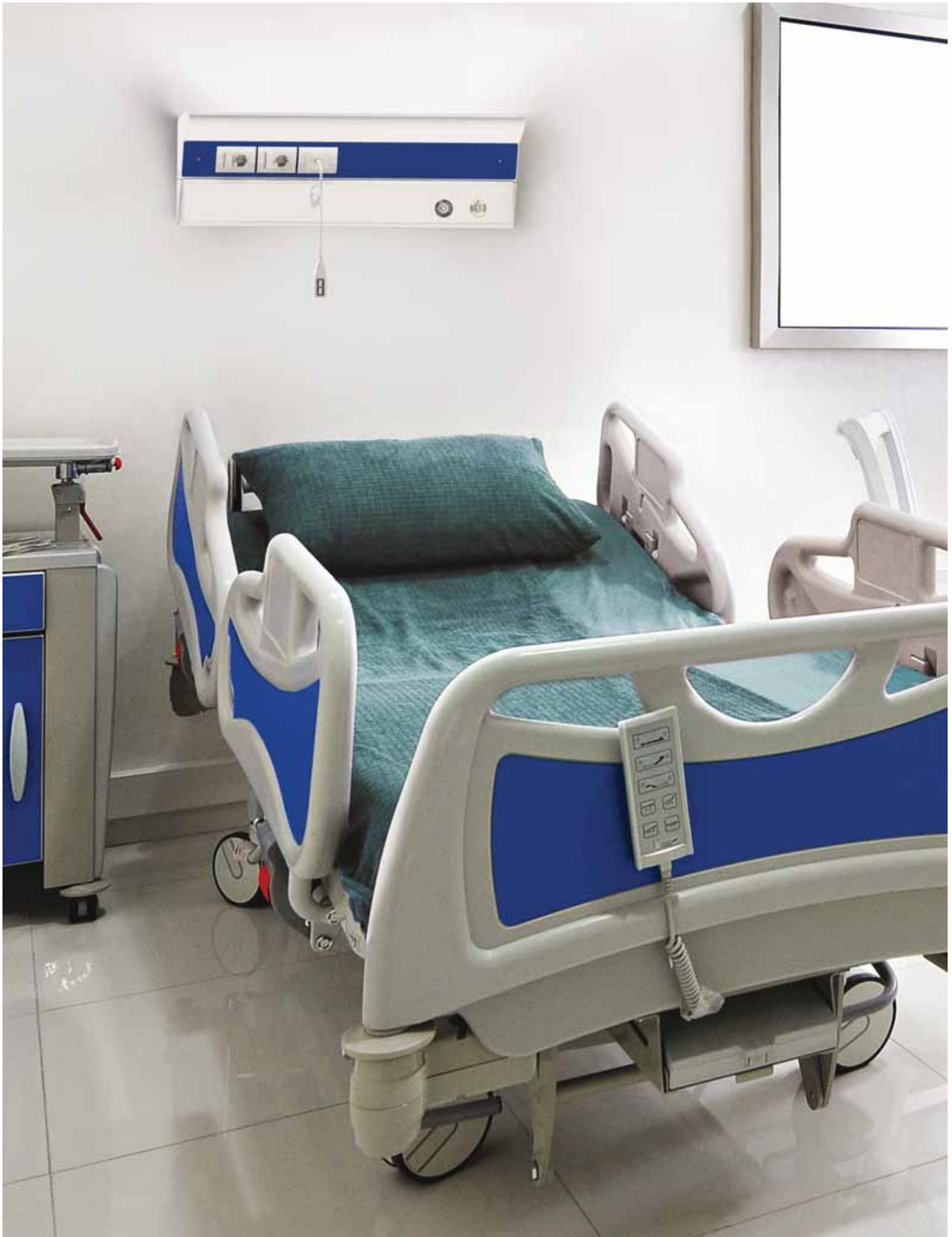

14 applique interni/esterni
wall lights indoor/outdoor

150 plafoniere interni/esterni
ceiling bowls indoor/outdoor

248 testaletto
bed head units

258 sospensioni
suspensions

344 lampade
lamps

384 lampioni ed incassi
bollards & recessed lights

450 indice
index



Fly

Apparecchio progettato per Case di Riposo e Assistenza per gli Anziani. Diffusore in policarbonato colore anice. Struttura in alluminio estruso con particolari in pressofusione di alluminio, verniciatura in polvere poliesteri con trattamento di fosfatazione. Conforme alle normative EN60601-1, EN ISO 11197:2009, classe I, direttiva 93/42/CEE e ss.mm.ii.

Fitting realized for Care Homes and Residential Care Homes. Diffuser made in polycarbonate colour anise. Structure made in extruded aluminium and die casting aluminium parts. Polyester paint with phosphate treatment. Compliant with standard EN60601-1, EN ISO 11197:2009, classe I, directive 93/42/CEE.

Appareil réalisé pour Maison de santé et Maisons de retraite. Diffuseur en polycarbonate couleur anis. Structure réalisée en extrusion d'aluminium avec parties en fonte d'aluminium. Vernis polyester et traitement de phosphatation. Conforme aux normes EN60601-1, EN ISO 11197:2009, classe I, directive 93/42/CEE.

Aparato diseñado para Residencias de Ancianos y Asistencia de Ancianos. Difusor de policarbonato color anís. Estructura de aluminio extrudido con detalles fundidos a presión de aluminio, pintura en polvo poliéster con tratamiento de fosfatación. Conformidad con la normativa EN60601-1, EN ISO 11197:2009, classe I, direttiva 93/42/CEE.

Gerät für Alters- und Pflegeheime. Diffusor aus anisfarbenem Polycarbonat. Struktur aus Aluminium extrusion mit Einzelteilen aus Aludruckguss, Lackierung aus Polyesterpulver mit Phosphatierung. Vorschriften EN60601-1, EN ISO 11197:2009, classe I, Direktive 93/42/CEE.

Fly 600.1

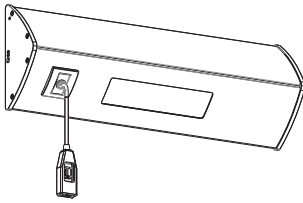

Fly 600.2

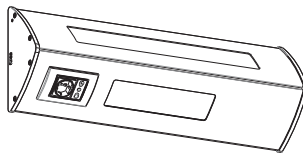

Fly 900.1

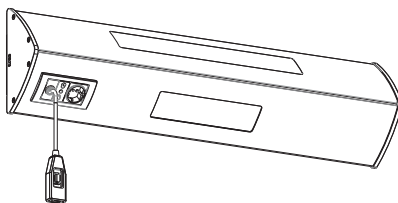

Fly 900.2

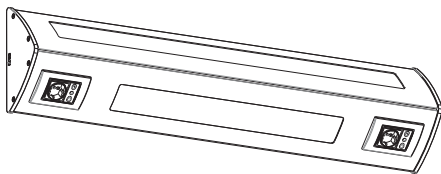

Fly 900.3

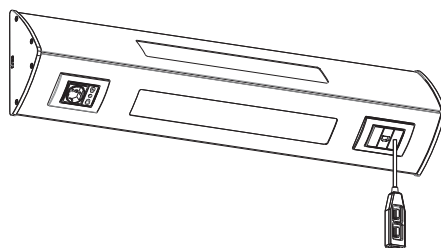

Fly 1200.1

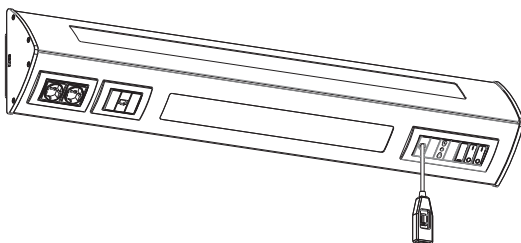

Testaletto per luce diretta e indiretta con accensione separata.
Possibilità di alloggiare la luce notturna sulla parte posteriore dell'apparecchio.
La versatilità del sistema permette di variare la lunghezza della struttura secondo le sorgenti luminose installate:

- TC-L 18-24-36-55W - T5 24-39-54W - LED

Gli accessori di comando, le prese elettriche e la finitura esterna possono cambiare a richiesta del cliente.

La progettazione e il preventivo vengono eseguiti per ogni singola composizione.

Bed head unit for direct and indirect light with separate lighting-up
Possibility to install the night light on the back of the fitting.

The system versatility allows to modify the length of the body according the light sources installed:

- TC-L 18-24-36-55W - T5 24-39-54W - LED

Control accessories, sockets and outside finish can change, based on client request.

Project and estimated cost are performed on every single version request.

Module tête de lit avec lumière directe et indirecte, avec allumage séparé.

Possibilité de commander la lumière de nuit sur la partie arrière de l'appareil.

La modularité de ce système permet aussi de modifier la longueur du corps suivant les sources utilisées:

- TC-L 18-24-36-55W - T5 24-39-54W - LED

Les accessoires de commande électrique, les prises et la finition extérieure peuvent changer selon la demande du client

Le projet et le devis seront réalisés selon chaque composition particulière.

Dispositivo para cabeza de cama para luz directa e indirecta con encendido separado.
Posibilidad de colocar la luz nocturna en la parte posterior del aparato.

La versatilidad del sistema permite variar la longitud de la estructura según las fuentes luminosas instaladas:

- TC-L 18-24-36-55W - T5 24-39-54W - LED

Los accesorios de mando, las tomas eléctricas y el acabado externo pueden cambiar a petición del cliente.

El proyecto y el presupuesto se hacen para cada composición.

Leuchte für direktes und indirektes Licht mit getrennter Einschaltvorrichtung.

Das Nachtlicht kann bei Bedarf auf der Rückseite des Geräts installiert werden.

Das vielseitig anwendbare System ermöglicht es die Länge der Struktur an die Art der installierten Lichtquelle anzupassen:

- TC-L 18-24-36-55W - T5 24-39-54W - LED

Die Steuerung, die elektrischen Anschlüsse und die externe Fertigung können auf die Bedürfnisse des Kunden abgestimmt werden.

Planung und Kostenvoranschlag werden spezifisch für jedes einzelne Projekt ausgearbeitet.

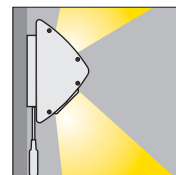





Sospensioni - Suspensions



Tuttotondo 262



Yoyo 268



Filo IP65 294



Flash 296



Vog 298



Job 300



Area 302



Moon 306



Nordica 328



Girotondo 330



Artika 332



Work 334



Railroad 336



Trilyum 340



NEW  Tab S Led 274



 Mono 278

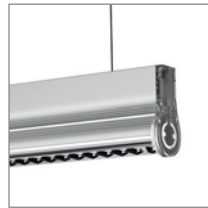

Mono DK 283



 Duo 284



Duo DK 289



360 LC 290



 Solarium led 308



 Cosmo 310



 Stilo 314



NEW  Stilo C 314



NEW  Asia 320



Open 324





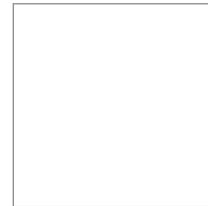

 Zeus 342

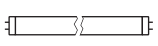

NEW Nuovo prodotto *New product*

 Versione LED *LED version*

 Versione RGB *RGB version*

2G11 			G5 			Gx24d/Gx24q 					LED 	RGB 	EMERGENZA EMERGENCY	PAG./PAGE	ARTICOLO/ITEM		
TC-L/TC-LE		FSD	T5	FDH		TC-T/TC-TE		FSMH									
6 X	8 X	12 X	1 X	2 X	4 X	1 X	2 X	3 X	4 X	6 X							
						42	42		42		23,1/34,1			○	302	AREA	
						42										332	ARTIKA
											8,33...34,1					320	ASIA
						42	42				14,9					310	COSMO
				39/54/80	39/54/80						37,4...114,6			○		284	DUO
				39/54/80	39/54/80											284	DUO DK
				54							91,6			○		294	FILO IP65
											28,4					296	FLASH
																330	GIROTONDO
						42	42		42					○		300	JOB
			39/54/80	39/54/80							18,7...57,3			○		278	MONO
			39/54/80	39/54/80												278	MONO DK
							42				34,1					306	MOON
																328	NORDICA
						42	42									324	OPEN
											34,1					336	RAILROAD
											15,3					308	SOLARIUM LED
							42	42	42		23,1/44,7			○		314	STILO
							42	42	42		23,1/44,7			○		314	STILO/C
											14,7...58,8					274	TAB S
																340	TRILYUM
	36	55									76,5/122,4			○		262	TUTTOTONDO
												12/18				266	TUTTOTONDO RGB
											24					298	VOG
						42					34,1					334	WORK
									42	42	34,1/46,5			○		268	YOYO
							42				15,3	20				272	YOYO RGB
											17					342	ZEUS

14 applique interni/esterni
wall lights indoor/outdoor

150 plafoniere interni/esterni
ceiling bowls indoor/outdoor

248 testaleto
bed head units

258 sospensioni
suspensions

344 lampade
lamps

384 lampioni ed incassi
bollards & recessed lights

450 indice
index



Tuttotondo

Lampada a sospensione per illuminazione di ambienti con luce diretta e indiretta. Diffusori in policarbonato colore anice. Struttura in metallo calandrato e verniciato con la superficie interna riflettente. Rosone in metallo verniciato bianco ral 9016. Tutte le sospensioni sono cablate con doppia accensione separata. **Versione LED equipaggiata con led smd e alimentatore elettronico incorporato. La finitura può cambiare a richiesta del cliente.**

Suspension lamp to illuminate with direct and indirect light. Diffusers made in polycarbonate anise colour. Structure made in curved painted metal with inside reflecting surface Top metal cover white painted ral 9016. All suspensions are equipped with double separate lighting. **LED version equipped with smd led and electronic driver included. Finish can change based on client request.**

Lampe à suspension pour éclairage avec lumière directe et indirecte. Diffuseurs en polycarbonate couleur anis. Structure réalisé en métal incurvé et verni avec la surface interne réfléchissante. Patère en métal verni blanc ral 9016. Toutes les suspensions sont équipées avec allumage double séparée. **Version LED équipée avec led smd et ballast électronique incorporé. La finition peu changé selon la demande du client.**



Lámpara de suspensión para iluminación de ambientes con luz directa e indirecta. Difusores de policarbonato color anís. Estructura de metal curvado y pintado con superficie interna reflectante. Rosetón de metal pintado blanco ral 9016. Todas las lámparas están cableadas para doble encendido separado. **Version LED suministrada con led smd y alimentador electrónico incluido. Acabado puede cambiar a petición del cliente.**

Hängeleuchte zur Beleuchtung von Räumen mit direktem und indirektem Licht. Diffusoren aus anisfarbenem Polycarbonat. Struktur aus gebogenem und lackiertem Metall mit reflektierender Innenfläche. Rosette aus weiß lackiertem Metall Ral 9016. Alle Hängeleuchten sind für das doppelte getrennte Einschalten verkabelt. **Ausführung LED zum led smd und integriert Versorgungsgerät elektronisch. Die Farben können auf die Bedürfnisse des Kunden abgestimmt werden.**

Colore struttura Structure color

Tuttotondo 600

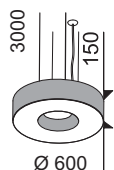

Articolo Item	Colore struttura Structure color			W _{max}	Icon	LUMEN	Icon	LUMEN/W	Icon
	AL	BI	NE						
● E27 tuttotondo 600	71026	71023	71027	6x23 FBT	E27	9000	IP20	⊕	65 A
● EL tuttotondo 600 EL	77166	77161	77167	6x26	G24q-3	10800	IP20	⊕	69 A
● DM tuttotondo 600 DM	77176	77171	77177	6x26	G24q-3	10800	IP20	⊕	69 A
● EM tuttotondo 600 EM	70266	70261	70267	6x26	G24q-3	10800	IP20	⊕	69 A

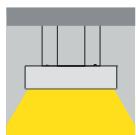

● Led tuttotondo 600 led-W	74256	74251	74257	76,5	led	10350	IP20	⊕	135 B
● Led DM tuttotondo 600 DM led-W	74266	74261	74267	76,5	led	10350	IP20	⊕	135 B
● Led EM tuttotondo 600 EM led-W	74276	74271	74277	76,5	led	10350	IP20	⊕	135 B
● Led tuttotondo 600 led-N	74286	74281	74287	76,5	led	10350	IP20	⊕	135 B
● Led DM tuttotondo 600 DM led-N	74296	74291	74297	76,5	led	10350	IP20	⊕	135 B
● Led EM tuttotondo 600 EM led-N	74306	74301	74307	76,5	led	10350	IP20	⊕	135 B

Tuttotondo 900

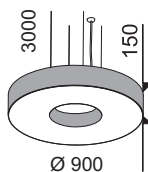

● E27 tuttotondo 900	71036	71033	71037	8x23 FBT	E27	12000	IP20	⊕	65 A
● EL tuttotondo 900 EL	77186	77181	77187	8x26	G24q-3	14400	IP20	⊕	69 A
● DM tuttotondo 900 DM	77196	77191	77197	8x26	G24q-3	14400	IP20	⊕	69 A
● EM tuttotondo 900 EM	70276	70271	70277	8x26	G24q-3	14400	IP20	⊕	69 A

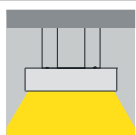

● Led tuttotondo 900 led-W	74316	74311	74317	122,4	led	16560	IP20	⊕	135 B
● Led DM tuttotondo 900 DM led-W	74326	74321	74327	122,4	led	16560	IP20	⊕	135 B
● Led EM tuttotondo 900 EM led-W	74336	74331	74337	122,4	led	16560	IP20	⊕	135 B
● Led tuttotondo 900 led-N	74346	74341	74347	122,4	led	16560	IP20	⊕	135 B
● Led DM tuttotondo 900 DM led-N	74356	74351	74357	122,4	led	16560	IP20	⊕	135 B
● Led EM tuttotondo 900 EM led-N	74366	74361	74367	122,4	led	16560	IP20	⊕	135 B

Colore struttura Structure color

● Nuova versione New version

AL RAL 9006 Alluminio Aluminium	BI RAL 9016 Bianco opaco Matt white	NE RAL 9005 Nero opaco Matt black
---	---	---

Led Equipaggiata con led 3000K - Equipped with led 3000K

Led Equipaggiata con led 4000K - Equipped with led 4000K

Led DM **Led DM** **DM** Dimmerabile PUSH/DALI
Dimmable PUSH/DALI (info page 10)

Led EM **Led EM** **EM** Emergenza (SA) 1h di serie - 3h a richiesta
Emergency 1h standard - 3h on request

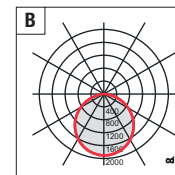
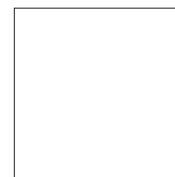
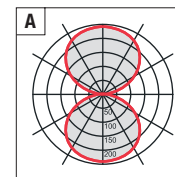

Tuttotondo 1200

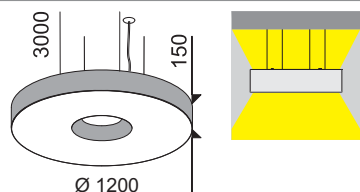

Articolo <i>Item</i>	Colore struttura <i>Structure color</i>			W _{max}		LUMEN		LUMEN/W	
	AL	BI	NE						
EL tuttotondo 1200 EL	77066	77061	77067	8x36	2G11	23200	IP20	⊕	81 A
DM tuttotondo 1200 DM	77086	77081	77087	8x36	2G11	23200	IP20	⊕	81 A
EM tuttotondo 1200 EM	70666	70661	70667	8x36	2G11	23200	IP20	⊕	81 A

Tuttotondo 1800

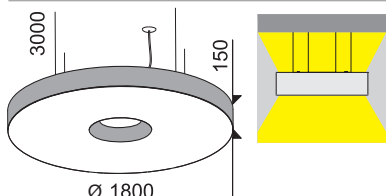

EL tuttotondo 1800 EL	77096	77091	77097	12x55	2G11	57600	IP20	⊕	87 A
DM tuttotondo 1800 DM	77116	77111	77117	12x55	2G11	57600	IP20	⊕	87 A
EM tuttotondo 1800 EM	70696	70691	70697	12x55	2G11	57600	IP20	⊕	87 A

Colore struttura *Structure color*

AL RAL 9006 Alluminio <i>Aluminium</i>	BI RAL 9016 Bianco opaco <i>Matt white</i>	NE RAL 9005 Nero opaco <i>Matt black</i>
--	--	--

DM Dimmerabile PUSH/DALI
Dimmable PUSH/DALI (info page10)

EM Emergenza (SA) 1h di serie – 3h a richiesta
Emergency 1h standard – 3h on request

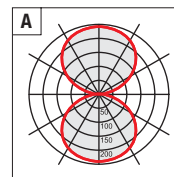



Tuttotondo RGB

La versione RGB per missaggio di luci colorate è equipaggiata con LED smd Full Color, alimentatore elettronico e modulo per controllo ciclo colore incorporati. La versione RGB è equipaggiata anche con lampade fluorescenti bianche per illuminazione diretta e indiretta. **La finitura può cambiare a richiesta del cliente.**

RGB version for coloured lights mixing is equipped with LED smd Full Color, electronic gear included to control colour cycle. RGB version is also equipped with white fluorescent bulbs for direct and indirect light. **Finish can change based on client request.**

Version RGB pour mixage de lumières colorées est équipée avec LED smd Full Color, ballast électronique incorporé pour contrôler le cycle des couleurs. La version RGB est aussi équipée avec ampoules fluorescent blanc pour lumière directe et indirecte. **La finition peu changé selon la demande du client.**

Versión RGB para mezclar las luces coloreadas es suministrada con LED smd Full Color, alimentador electrónico incorporado con módulo para el control del ciclo de color. La versión RGB es suministrada también con lamparas fluorescente blancas b para una luz dirceta y indirecta. **Acabado puede cambiar a petición del cliente.**

Ausführung RGB zur Mischung bunter Lichter Ausführung zum LED smd Full Color, elektronisches Versorgungsgerät mit Modul zur Farbzykluskontrolle integriert. Ausführung RGB auch zum weiß Leuchtstofflampen ausgerüstet für direktem und indirektem Licht. **Die Farben können auf die Bedürfnisse des Kunden abgestimmt werden.**

Colore struttura Structure color

Tuttotondo 600 RGB

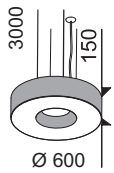

Articolo Item	Colore struttura Structure color			W _{max}	G24q-3	LUMEN	IP20	LUMEN/W	A
	AL	BI	NE						
● DMDIG tuttotondo 600 DM RGB DIG	70746	70741	70747	6x26 12	G24q-3 led RGB	10800 720	IP20	69 60	A (nd)
● DMDALI tuttotondo 600 DM RGB DALI	70756	70751	70757	6x26 12	G24q-3 led RGB	10800 720	IP20	69 60	A (nd)

Tuttotondo 900 RGB

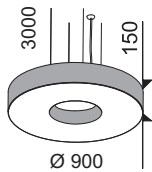

● DMDIG tuttotondo 900 DM RGB DIG	70766	70761	70767	8x26 18	G24q-3 led RGB	14400 1080	IP20	69 60	A (nd)
● DMDALI tuttotondo 900 DM RGB DALI	70776	70771	70777	8x26 18	G24q-3 led RGB	14400 1080	IP20	69 60	A (nd)

Colore struttura Structure color

AL RAL 9006 Alluminio Aluminium	BI RAL 9016 Bianco opaco Matt white	NE RAL 9005 Nero opaco Matt black
---	---	---

● Nuova versione New version

DMDIG Miscelazione colore RGB digitale + Fluo Dimmerabile PUSH
Digital color mixing RGB + Fluo Dimmable PUSH (info page 10)

DMDALI Miscelazione colore RGB DALI + Fluo Dimmerabile DALI
DALI color mixing RGB + Fluo Dimmable DALI (info page 10)

(nd) Non disponibile - Not available

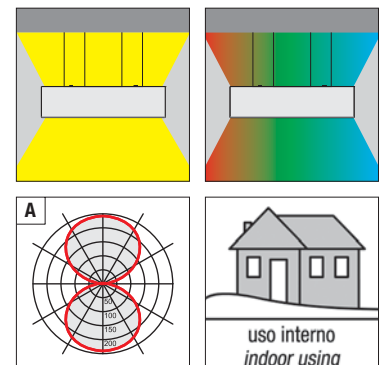

YoYo

Lampada a sospensione per illuminazione di ambienti con luce diffusa. Diffusore stampato rotazionale in polietilene bianco. Particolari colore bianco o con finitura cromata. Struttura interna e rosone in metallo verniciato bianco ral 9016. La sospensione diametro 900 mm è cablata per accensione separata (4+2). **Versione LED equipaggiata con led smd e alimentatore elettronico incorporato.**

Suspension lamp to illuminate with diffused light. Diffuser rotational moulded, realized in white polyethylene. Details coloured white or chrome finish. Inside structure and top metal cover made of white painted metal, ral 9016. The fitting diameter 900 mm is cabled for separate lighting-up (4+2). **LED version equipped with smd led and electronic driver included.**

Lampe à suspension pour éclairage avec lumière diffuse. Diffuseur moulé rotatif, en polyéthylène blanc. Détail couleur blanc ou avec finition chromé. Structure intérieure et patère en métal verni blanc, ral 9016. La suspension diamètre 900 mm est câblée pour allumage séparé (4+2). **Version LED équipée avec led smd et ballast électronique incorporé.**

Lámpara de suspensión para iluminación de ambientes con luz difusa. Pantalla difusora moldeado rotacional de polietileno blanco. Detalles color blanco o con acabado cromado. Estructura interna y rosetón de metal pintado blanco ral 9016. La suspensión diámetro 900 mm está cableada para encendido separado (4+2). **Version LED suministrada con led smd y alimentador electrónico incluido.**

Hängeleuchte zur Beleuchtung von Räumen mit diffusem Licht. Formgestanzter Rotationsdiffusor aus weißem polyethylen. Der Einzelteile ist weiß oder verchromt. Die interne Metallstruktur ist weiß lackiert, gemäß Ral 9016. Rosette aus weiß lackiert metal Ral 9016. Die Hängeleuchte mit Durchmesser 900 mm verfügt über eine Verkabelung für getrennte Einschaltvorrichtung (4+2). **Ausführung LED zum led smd und integriert Versorgungsgerät elektronisch.**



Colore decoro Details color

YoYo 600

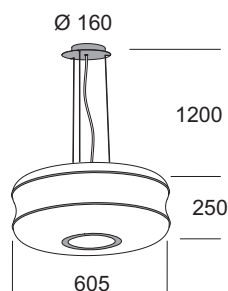

Articolo Item	Colore decoro Details color		W _{max}		LUMEN		LUMEN/W	
	BI Codice	CR Code						
E27 yoyo 600	71981	71980	4x57	E27	3660	IP20	16	A
● Led yoyo 600 led-W	74371	74370	34,1	led	3550	IP20	104	C
● Led DM yoyo 600 DM led-W	74381	74380	34,1	led	3550	IP20	104	C
● Led EM yoyo 600 EM led-W	74391	74390	34,1	led	3550	IP20	104	C
● Led yoyo 600 led-N	74401	74400	34,1	led	3550	IP20	104	C
● Led DM yoyo 600 DM led-N	74411	74410	34,1	led	3550	IP20	104	C
● Led EM yoyo 600 EM led-N	74421	74420	34,1	led	3550	IP20	104	C
EL yoyo 600 EL	79021	79020	4x42(a)	GX24q-4	12800	IP20	76	A
DM yoyo 600 DM	79131	79130	4x42	GX24q-4	12800	IP20	76	A
EM yoyo 600 EM	70211	70210	4x42(a)	GX24q-4	12800	IP20	76	A

YoYo 900

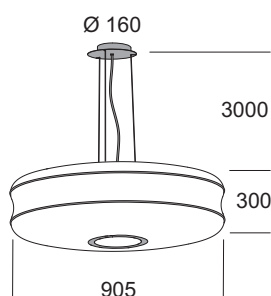

E27 yoyo 900	71991	71990	6x57	E27	5490	IP20	16	B
● Led yoyo 900 led-W	74431	74430	46,5	led	5580	IP20	120	C
● Led DM yoyo 900 DM led-W	74441	74440	46,5	led	5580	IP20	120	C
● Led EM yoyo 900 EM led-W	74451	74450	46,5	led	5580	IP20	120	C
● Led yoyo 900 led-N	74461	74460	46,5	led	5580	IP20	120	C
● Led DM yoyo 900 DM led-N	74471	74470	46,5	led	5580	IP20	120	C
● Led EM yoyo 900 EM led-N	74481	74480	46,5	led	5580	IP20	120	C
EL yoyo 900 EL	79041	79040	6x42(a)	GX24q-4	19200	IP20	76	B
DM yoyo 900 DM	79151	79150	6x42	GX24q-4	19200	IP20	76	B
EM yoyo 900 EM	70221	70220	6x42(a)	GX24q-4	19200	IP20	76	B

Colore decoro Details color

● Nuova versione New version

BI	CR
Bianco White	Cromato Chrome

● Led Equipaggiata con led 3000K - Equipped with led 3000K

● Led Equipaggiata con led 4000K - Equipped with led 4000K

● Led DM ● Led DM ● DM Dimmerabile PUSH/DALI
Dimmable PUSH/DALI (info page10)

● Led EM ● Led EM ● EM Emergenza (SA) 1h di serie - 3h a richiesta
Emergency 1h standard - 3h on request

(a) Equipaggiato con alimentatore multipotenza per l'utilizzo di lampade da 26W-32W o 42W
Equipped with multi-power ballast to use bulbs of 26W-32W or 42W

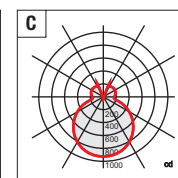
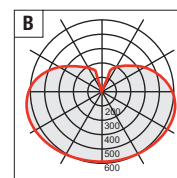
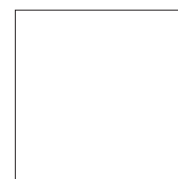
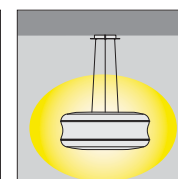
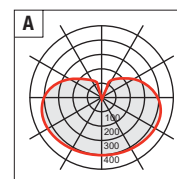



14 applique interni/esterni
wall lights indoor/outdoor

150 plafoniere interni/esterni
ceiling bowls indoor/outdoor

248 testaletto
bed head units

258 sospensioni
suspensions

344 lampade
lamps

384 lampioni ed incassi
bollards & recessed lights

450 indice
index



YoYo RGB

Lampada a sospensione per illuminazione di ambienti con luce diretta bianca e diffusa colorata RGB **con accensioni separate**. La versione RGB per missaggio di luci colorate è equipaggiato con LED smd Full Color, alimentatore elettronico incorporato e modulo per controllo ciclo colore. La versione DM è equipaggiata anche per lampade fluorescenti per illuminazione diretta.

Suspension lamp to illuminate with white direct light and coloured diffused light by RGB system **with separate lightings**. RGB version for coloured lights mixing is equipped with LED smd Full Color, electronic gear included to control colour cycle. DM version is also equipped for fluorescent bulbs for direct light.

Lampe à suspension pour éclairage avec lumière directe blanc et lumière diffuse colorée avec system RGB **avec allumage séparé**. Version RGB pour mixage de lumières colorées est équipée avec LED smd Full Color, ballast électronique

incorporé pour contrôler le cycle des couleurs. La version DM est aussi équipée pour ampoule fluorescent pour lumière directe.

Lámpara de suspensión para iluminación de ambientes con luz directa blanca y luz difusa coloreada con sistema RGB **con encendido separado**. Versión RGB para mezclar las luces coloreadas es suministrado con LED smd Full Color, alimentador electrónico incorporado con módulo para el control del ciclo de color. La versión DM es suministrada también para lámpara fluorescente para una luz directa.

Hängeleuchte zur Beleuchtung von Räumen mit weiß direktem Licht und farbigen diffusem Licht mit RGB System **mit getrennter Einschaltvorrichtung**. Ausführung RGB zur Mischung bunter Lichter Ausführung zum LED smd Full Color, elektronisches Versorgungsgerät mit Modul zur Farbzkluskontrolle integriert. Ausführung DM auch für Leuchtstofflampe ausgerüstet für direkte Licht.

YoYo 600 RGB

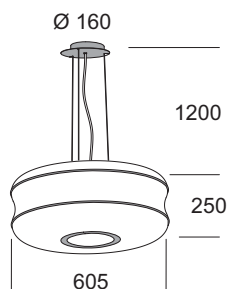

Articolo <i>Item</i>	Colore decoro <i>Details color</i>		W _{max}	led	LUMEN	IP	LUMEN/W	B
	BI Codice	CR Code						
● LedDIG yoyo 600 LED-W RGB DIG	70781	70780	15,3 20	led led RGB	2070 1200	IP20	⊕ ⊕	135 60 B (nd)
● LedDALI yoyo 600 LED-W RGB DALI	70791	70790	15,3 20	led led RGB	2070 1200	IP20	⊕ ⊕	135 60 B (nd)
● LedDIG yoyo 600 LED-N RGB DIG	70801	70800	15,3 20	led led RGB	2070 1200	IP20	⊕ ⊕	135 60 B (nd)
● LedDALI yoyo 600 LED-N RGB DALI	70811	70810	15,3 20	led led RGB	2070 1200	IP20	⊕ ⊕	135 60 B (nd)
DMDIG yoyo 600 DM RGB DIG	70561	70560	2x42(a) 20	GX24q-4 led RGB	6400 1200	IP20	⊕ ⊕	76 60 A (nd)
DMDALI yoyo 600 DM RGB DALI	70571	70570	2x42(a) 20	GX24q-4 led RGB	6400 1200	IP20	⊕ ⊕	76 60 A (nd)

YoYo 900 RGB

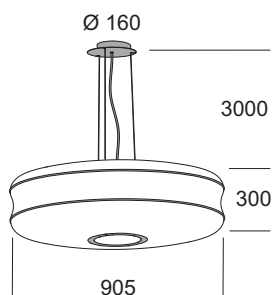

● LedDIG yoyo 900 LED-W RGB DIG	70821	70820	15,3 20	led led RGB	2070 1200	IP20	⊕ ⊕	135 60 B (nd)
● LedDALI yoyo 900 LED-W RGB DALI	70831	70830	15,3 20	led led RGB	2070 1200	IP20	⊕ ⊕	135 60 B (nd)
● LedDIG yoyo 900 LED-N RGB DIG	70841	70840	15,3 20	led led RGB	2070 1200	IP20	⊕ ⊕	135 60 B (nd)
● LedDALI yoyo 900 LED-N RGB DALI	70851	70850	15,3 20	led led RGB	2070 1200	IP20	⊕ ⊕	135 60 B (nd)
DMDIG yoyo 900 DM RGB DIG	70581	70580	2x42(a) 20	GX24q-4 led RGB	6400 1200	IP20	⊕ ⊕	76 60 A (nd)
DMDALI yoyo 900 DM RGB DALI	70591	70590	2x42(a) 20	GX24q-4 led RGB	6400 1200	IP20	⊕ ⊕	76 60 A (nd)

Colore decoro *Details color*

● Nuova versione *New version*

BI Bianco <i>White</i>	CR Cromato <i>Chrome</i>
----------------------------------	------------------------------------

- LedDIG** Accensioni separate per illuminare con led 3000K e/o sistema RGB led.
Separate lightings to illuminate with led 3000K and/or RGB led system. (info page 10)
- LedDALI** Accensioni separate per illuminare con led 4000K e/o sistema RGB led.
Separate lightings to illuminate with led 4000K and/or RGB led system. (info page 10)
- LedDIG** Accensioni separate per illuminare con led 4000K e/o sistema RGB led.
Separate lightings to illuminate with led 4000K and/or RGB led system. (info page 10)
- LedDALI** Accensioni separate per illuminare con led 4000K e/o sistema RGB led.
Separate lightings to illuminate with led 4000K and/or RGB led system. (info page 10)
- DMDIG** Miscelazione colore RGB digitale + Fluo Dimmerabile PUSH
Digital color mixing RGB + Fluo Dimmable PUSH (info page 10)
- DMDALI** Miscelazione colore RGB DALI + Fluo Dimmerabile DALI
DALI color mixing RGB + Fluo Dimmable DALI (info page 10)

(a) Equipaggiato con alimentatore multipotenza per l'utilizzo di lampade da 26W-32W o 42W
Equipped with multi-power ballast to use bulbs of 26W-32W or 42W

(nd) Non disponibile - *Not available*

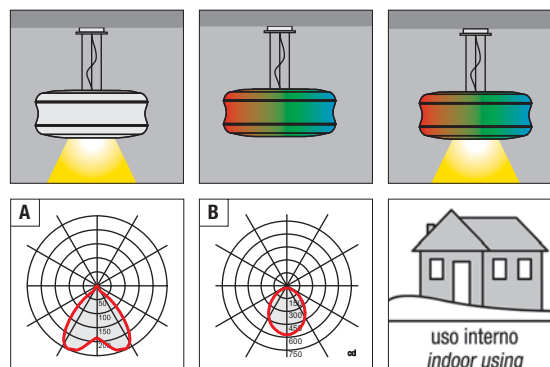

Tab S Led

Lampada a sospensione per illuminazione di ambienti con luce diretta. Struttura in metallo verniciato e policarbonato bianco o colore alluminio. Diffusori in policarbonato trasparente, con pellicola di policarbonato opale inserita internamente. Anello esterno in policarbonato anice o con finitura alluminio ral 9006. **Equipaggiata con LED smd e alimentatore elettronico incorporato.**

Suspension lamp to illuminate with direct light. Structure made in painted metal and white or aluminium colour polycarbonate. Diffusers made in transparent polycarbonate with inside opal polycarbonate film. Ring made in polycarbonate anis colour or painted aluminium ral 9006. **Equipped with smd LED and electronic driver included.**

Lampe à suspension pour éclairage avec lumière directe. Structure réalisée en métal verni et polycarbonate blanc ou couleur aluminium. Diffuseurs en polycarbonate transparente avec un film de polycarbonate opale à l'intérieur. Anneau en polycarbonate anis ou verni aluminium ral 9006. **Equipée avec LED smd et ballast électronique incorporé**

Lámpara de suspensión para iluminación de ambientes con luz directa. Estructura en metal pintado y policarbonato blanco o colores aluminio. Difusores de policarbonato transparente, con una película interna de policarbonato opale. Anillo de policarbonato de color anís o colores aluminio ral 9006. **Suministrada con LED smd y alimentador electrónico incluido.**

Hängeleuchte zur Beleuchtung von Räumen mit direktem Licht. Struktur aus lackiertem Metall und weiß oder aluminium Polycarbonat. Diffusoren aus transparentem Polycarbonat mit eine innen Opal Polycarbonatfilm. Ring aus anisfarbenem Polycarbonat, Farbe Aluminium Ral 9006. **Ausgestattet zum LED smd und integriert Versorgungsgerät elektronisch.**



Colore struttura Structure color

Tab S1 Led

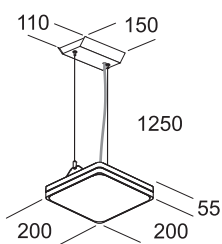

Articolo Item	Colore struttura Structure color		W _{max}		LUMEN		LUMEN/W	
	BI Codice	AL Code						
tab S1 led-W	75341	75346	14,7	led	2190	IP20	⊕ 149	A
tab S1 DM led-W	75351	75356	14,7	led	2190	IP20	⊕ 149	A
tab S1 led-N	75361	75366	14,7	led	2190	IP20	⊕ 149	A
tab S1 DM led-N	75371	75376	14,7	led	2190	IP20	⊕ 149	A

Tab S2 Led

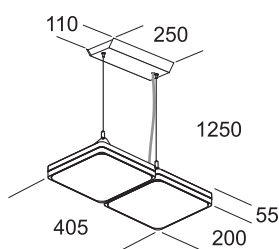

tab S2 led-W	75381	75386	29,4	led	4380	IP20	⊕ 149	A
tab S2 DM led-W	75391	75396	29,4	led	4380	IP20	⊕ 149	A
tab S2 led-N	75401	75406	29,4	led	4380	IP20	⊕ 149	A
tab S2 DM led-N	75411	75416	29,4	led	4380	IP20	⊕ 149	A

Colore struttura Structure color

RAL 9016 Bianco opaco <i>Matt white</i>	RAL 9006 Alluminio <i>Aluminium</i>
---	---

- Equipaggiata con led 3000K - *Equipped with led 3000K*
- Equipaggiata con led 4000K - *Equipped with led 4000K*
- Dimmerabile PUSH/DALI
Dimmable PUSH/DALI (info page 10)

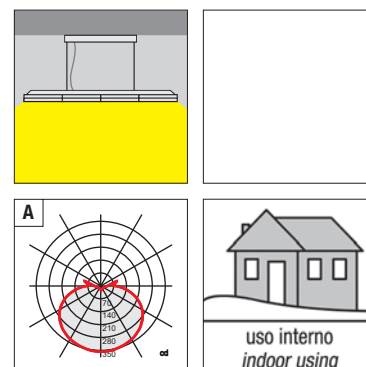

Tab S4 Led

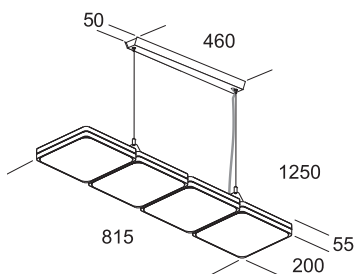

Colore struttura Structure color

Articolo Item	Colore struttura Structure color		W _{max}	LUMEN	LUMEN/W	IP	Beam angle	A
	BI Codice	AL Code						
Led tab S4 led-W	75421	75426	58,8	8760	149	IP20	30°	A
Led DM tab S4 DM led-W	75431	75436	58,8	8760	149	IP20	30°	A
Led tab S4 led-N	75441	75446	58,8	8760	149	IP20	30°	A
Led DM tab S4 DM led-N	75451	75456	58,8	8760	149	IP20	30°	A

Tab SQ Led

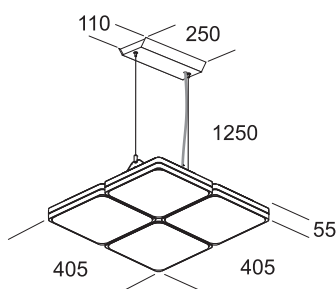

Led tab SQ led-W	75461	75466	58,8	8760	149	IP20	30°	A
Led DM tab SQ DM led-W	75471	75476	58,8	8760	149	IP20	30°	A
Led tab SQ led-N	75481	75486	58,8	8760	149	IP20	30°	A
Led DM tab SQ DM led-N	75491	75496	58,8	8760	149	IP20	30°	A

Colore struttura Structure color

BI RAL 9016
Bianco opaco *Matt white*

AL RAL 9006
Alluminio *Aluminium*

Led Equipaggiata con led 3000K - *Equipped with led 3000K*

Led Equipaggiata con led 4000K - *Equipped with led 4000K*

Led DM **Led DM** Dimmerabile PUSH/DALI
Dimmable PUSH/DALI (info page 10)

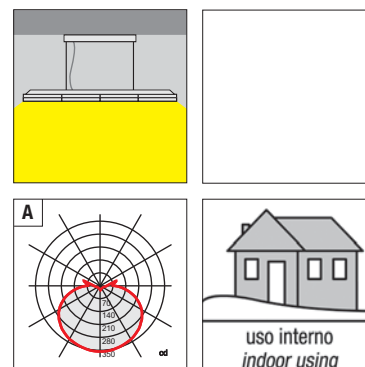

Mono - MonoDK

Lampada a sospensione per illuminazione di ambienti con luce diffusa o diretta (versione DK). Il diffusore ruota di 360° permettendo di orientare il fascio luminoso. Diffusore in policarbonato colore anice. Versione Dark Light con diffusore, non orientabile, in alluminio purissimo 99,99% brillantato conforme alla normativa EN 12464. La versione Dark Light diffonde la luce anche nella parte superiore aumentando il confort visivo. Struttura in alluminio estruso. Particolari in policarbonato trasparente. Rosone in policarbonato colore alluminio. **Versione LED equipaggiata con led smd e alimentatore elettronico incorporato.**

Suspension lamp to illuminate with diffused or direct light (DK version). The diffuser rotates on 360 degree permitting to orientate the luminous beam. Diffuser in polycarbonate colour anise. Dark light version with no-adjustable diffuser, realized in polished pure aluminium 99,99%, following rule EN12464. The dark light version also diffuses light indirectly improving visual comfort. Structure made in extruded aluminium. Details made in transparent polycarbonate. Top cover made in polycarbonate colour aluminium. **LED version equipped with smd led and electronic driver included.**

Lampe à suspension pour éclairage avec lumière diffuse ou directe (version DK). Le diffuseur tourne de 360 degré permettant d'orienter le flux lumineux. Diffuseur en polycarbonate couleur anis. Version Dark Light avec diffuseur, non orientable, en aluminium pur à 99,99% brillant conforme à la réglementation EN 12464. La version Dark Light diffuse la lumière même dans

sa partie supérieure en augmentant le confort visuel. Structure réalisée en extrusion d'aluminium. Détails en polycarbonate transparent. Patère en polycarbonate couleur aluminium. **Version LED équipée avec led smd et ballast électronique incorporé.**

Lámpara de suspensión para iluminación de ambientes con luz difusa o directa (versión DK). El difusor gira en 360° permitiendo orientar el rayo luminoso. Difusor de policarbonato color anís. Versión Dark Light con difusor, no orientable, en aluminio purísimo 99,99% abrigantado en conformidad con la normativa EN 12464. La versión Dark Light difunde la luz incluso en la parte superior aumentando el confort visual. Estructura de aluminio extrudido. Detalles de policarbonato transparente. Rosetón en policarbonato color aluminio. **Version LED suministrada con led smd y alimentador electrónico incluido.**

Hängeleuchte zur Beleuchtung von Räumen mit diffusem Licht oder direktem Licht (Version DK). Der Diffusor kann um 360° gedreht werden und ermöglicht auf diese Weise die Ausrichtung der Licht strahl. Diffusor aus anisfarbenem Polycarbonat. Version Dark Light mit Diffusor, nicht verstellbar, aus reinem polierten Aluminium 99,99%, gemäß EN 12464. Die Version Dark Light verbreitet das Licht auch im oberen Teil und erhöht somit den Sehkomfort. Struktur aus Aluminiumextrusion. Einzelteile aus transparentem Polykarbonat. Rosette aus alufarbenem Polykarbonat. **Ausführung LED zum led smd und integriert Versorgungsgerät elektronisch.**



Disponibile in versione Dark Light e installabile in linea continua.

Available in Dark Light version and suitable for continuous-row lighting.

Disponibile en version Dark Light et installable en ligne continue.

Disponibile en version Dark Light y instalable en línea continua.

Version Dark Light verfügbar und die Ausführung ist in Lichtbandversion.



14 applique interni/esterni
wall lights indoor/outdoor

150 plafoniere interni/esterni
ceiling bowls indoor/outdoor

248 testaletto
bed head units

258 sospensioni
suspensions

344 lampade
lamps

384 lampioni ed incassi
bollards & recessed lights

450 indice
index

Colore struttura Structure color

Mono 90

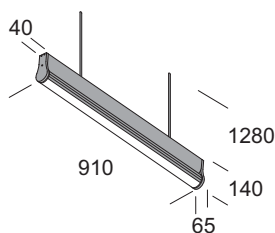

Articolo Item	Colore struttura Structure color		W _{max}	LUMEN	IP	LUMEN/W	C
	CR	AL					
	Codice Code						
● Led mono 90 led-W	74490	74496	18,7	2660	IP20	142	C
● mono 90S led-W	74500	74506	34,4	4690	IP20	136	C
● Led DM mono 90S DM led-W	74510	74516	34,4	4690	IP20	136	C
● Led EM mono 90 EM led-W	74520	74526	18,7	2660	IP20	142	C
● mono 90S EM led-W	74530	74536	34,4	4690	IP20	136	C
● Led mono 90 led-N	74540	74546	18,7	2660	IP20	142	C
● mono 90S led-N	74550	74556	34,4	4690	IP20	136	C
● Led DM mono 90S DM led-N	74560	74566	34,4	4690	IP20	136	C
● Led EM mono 90 EM led-N	74570	74576	18,7	2660	IP20	142	C
● mono 90S EM led-N	74580	74586	34,4	4690	IP20	136	C
EL mono 90/39 EL	78530	78536	1x39	G5 3500	IP20	90	A
mono 90/2x39 EL	78560	78566	2x39	G5 7000	IP20	90	B
DM mono 90/2x39 DM	79280	79286	2x39	G5 7000	IP20	90	B

Colore struttura Structure color

● Nuova versione New version

CR

Alluminio brillantato (effetto cromato) Shined aluminium (chrome effect)

AL

Alluminio anodizzato Oxided aluminium

Led Equipaggiata con led 3000K - Equipped with led 3000K

Led Equipaggiata con led 4000K - Equipped with led 4000K

Led DM Led DM DM Dimmerabile PUSH/DALI
Dimmable PUSH/DALI (info page10)

Led EM Led EM Emergenza (SA) 1h di serie - 3h a richiesta
Emergency 1h standard - 3h on request

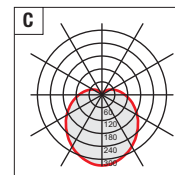
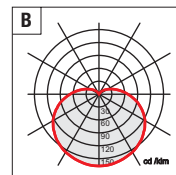
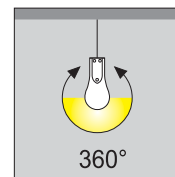
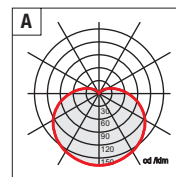

Mono 120

Colore struttura Structure color

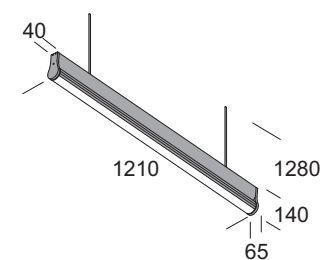

Articolo Item	Colore struttura Structure color		W _{max}	LED	LUMEN	IP	LUMEN/W	Icon
	CR	AL						
	Codice Code							
● Led mono 120 led-W	74590	74596	25	led	3620	IP20	⊕	145 C
● mono 120S led-W	74600	74606	45,8	led	6260	IP20	⊕	137 C
● Led DM mono 120S DM led-W	74610	74616	45,8	led	6260	IP20	⊕	137 C
● Led EM mono 120 EM led-W	74620	74626	25	led	3620	IP20	⊕	145 C
● mono 120S EM led-W	74630	74636	45,8	led	6260	IP20	⊕	137 C
● Led mono 120 led-N	74640	74646	25	led	3620	IP20	⊕	145 C
● mono 120S led-N	74650	74656	45,8	led	6260	IP20	⊕	137 C
● Led DM mono 120S DM led-N	74660	74666	45,8	led	6260	IP20	⊕	137 C
● Led EM mono 120 EM led-N	74670	74676	25	led	3620	IP20	⊕	145 C
● mono 120S EM led-N	74680	74686	45,8	led	6260	IP20	⊕	137 C
EL mono 120/54 EL	78540	78546	1x54	G5	5000	IP20	⊕	93 A
mono 120/2x54 EL	78570	78576	2x54	G5	10000	IP20	⊕	93 B
DM mono 120/2x54 DM	79300	79306	2x54	G5	10000	IP20	⊕	93 B

Colore struttura Structure color

● Nuova versione New version

CR
Alluminio brillantato (effetto cromato) *Shined aluminium (chrome effect)*

AL
Alluminio anodizzato *Oxided aluminium*

Led Equipaggiata con led 3000K - *Equipped with led 3000K*

Led Equipaggiata con led 4000K - *Equipped with led 4000K*

Led DM **Led DM** **DM** Dimmerabile PUSH/DALI
Dimmable PUSH/DALI (info page 10)

Led EM **Led EM** Emergenza (SA) 1h di serie – 3h a richiesta
Emergency 1h standard – 3h on request

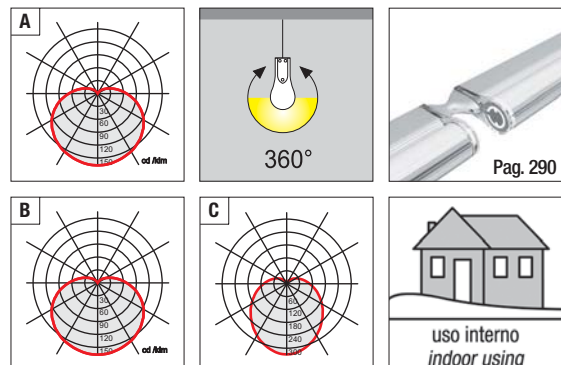

Mono 150

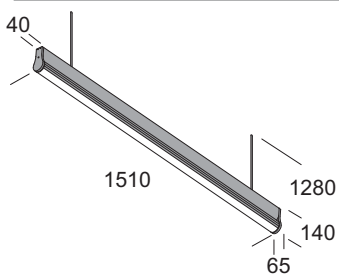

Articolo Item	Colore struttura Structure color		W _{max}	LUMEN	IP	LUMEN/W	C
	CR	AL					
	Codice Code						
● Led mono 150 led-W	74690	74696	31,2	4470	IP20	143	C
● mono 150S led-W	74700	74706	57,3	7820	IP20	136	C
● Led DM mono 150S DM led-W	74710	74716	57,3	7820	IP20	136	C
● Led EM mono 150 EM led-W	74720	74726	31,2	4470	IP20	143	C
● mono 150S EM led-W	74730	74736	57,3	7820	IP20	136	C
● Led mono 150 led-N	74740	74746	31,2	4470	IP20	143	C
● mono 150S led-N	74750	74756	57,3	7820	IP20	136	C
● Led DM mono 150S DM led-N	74760	74766	57,3	7820	IP20	136	C
● Led EM mono 150 EM led-N	74770	74776	31,2	4470	IP20	143	C
● mono 150S EM led-N	74780	74786	57,3	7820	IP20	136	C
EL mono 150/80 EL	78550	78556	1x80	G5 7000	IP20	87	A
mono 150/2x80 EL	78580	78586	2x80	G5 14000	IP20	87	B
DM mono 150/2x80 DM	79320	79326	2x80	G5 14000	IP20	87	B

Colore struttura Structure color

● Nuova versione New version

CR
Alluminio brillantato (effetto cromato) Shined aluminium (chrome effect)

AL
Alluminio anodizzato Oxided aluminium

Led Equipaggiata con led 3000K - Equipped with led 3000K

Led Equipaggiata con led 4000K - Equipped with led 4000K

Led DM **Led DM** **DM** Dimmerabile PUSH/DALI
Dimmable PUSH/DALI (info page10)

Led EM **Led EM** Emergenza (SA) 1h di serie – 3h a richiesta
Emergency 1h standard – 3h on request

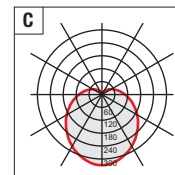
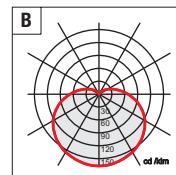
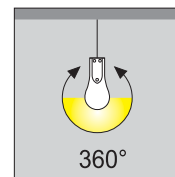
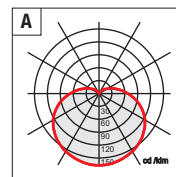

Colore struttura Structure color

MonoDK 90

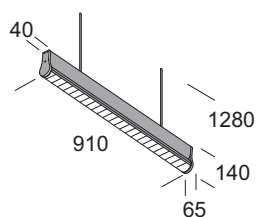

Articolo Item	Colore struttura Structure color		W _{max}		LUMEN		LUMEN/W	
	CR	AL						
	Codice Code							
EL monoDK 90/39 EL	78538	78539	1x39	G5	3500	IP20	90	A
	78568	78569	2x39	G5	7000	IP20	90	A
DM monoDK 90/2x39 DM	79288	79289	2x39	G5	7000	IP20	90	A

MonoDK 120

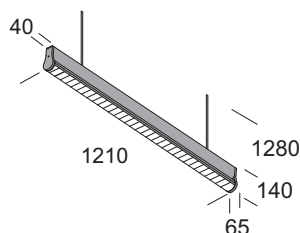

EL monoDK 120/54 EL	78548	78549	1x54	G5	5000	IP20	93	A
	78578	78579	2x54	G5	10000	IP20	93	A
DM monoDK 120/2x54 DM	79308	79309	2x54	G5	10000	IP20	93	A

MonoDK 150

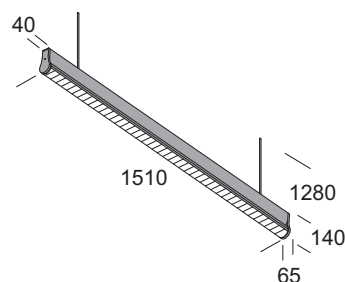

EL monoDK 150/80 EL	78558	78559	1x80	G5	7000	IP20	87	A
	78588	78589	2x80	G5	14000	IP20	87	A
DM monoDK 150/2x80 DM	79328	79329	2x80	G5	14000	IP20	87	A

Colore struttura Structure color

CR
Alluminio brillantato (effetto cromato) *Shined aluminium (chrome effect)*

AL
Alluminio anodizzato *Oxided aluminium*

DM Dimmerabile PUSH/DALI
Dimmable PUSH/DALI (info page 10)

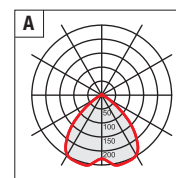
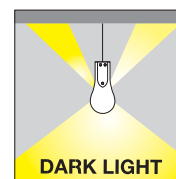

Duo - Duo DK

Lampada a sospensione per illuminazione di ambienti con luce diffusa o diretta (versione DK). Il diffusore ruota di 360° permettendo di orientare il fascio luminoso. Diffusore in policarbonato colore anice. Versione Dark Light con diffusore, non orientabile, in alluminio purissimo 99,99% brillantato conforme alla normativa EN 12464. La versione Dark Light diffonde la luce anche nella parte superiore aumentando il confort visivo. Struttura in alluminio estruso. Particolari in policarbonato trasparente. Rosone in policarbonato colore alluminio. Le versioni con 4 lampade sono cablate per doppia accensione separata. **Versione LED equipaggiata con led smd e alimentatore elettronico incorporato.**

Suspension lamp to illuminate with diffused or direct light (DK version). The diffuser rotates on 360 degree permitting to orientate the luminous beam. Diffuser in polycarbonate colour anise. Dark light version with no-adjustable diffuser, realized in polished pure aluminium 99,99%, following rule EN12464. The dark light version also diffuses light indirectly improving visual comfort. Structure made in extruded aluminium. Details made in transparent polycarbonate. Top cover made in polycarbonate colour aluminium. Versions cabled with 4 bulbs are equipped with double separate lighting. **LED version equipped with smd led and electronic driver included.**

Lampe à suspension pour éclairage avec lumière diffuse ou directe (version DK). Le diffuseur tourne de 360 degré permettant d'orienter le flux lumineux. Diffuseur en polycarbonate couleur anis. Version Dark Light avec diffuseur, non orientable, en aluminium pur à 99,99% brillant conforme à la réglementation EN 12464. La version Dark Light diffuse la lumière même dans sa partie supérieure en augmentant le confort visuel. Structure réalisée en extrusion d'aluminium. Détails en polycarbonate transparent. Patère en polycarbonate couleur aluminium. Les versions câblées avec 4 ampoules sont équipées avec allumage double séparée. **Version LED équipée avec led smd et ballast électronique incorporé.**

Lámpara de suspensión para iluminación de ambientes con luz difusa o directa (versión DK). El difusor gira en 360° permitiendo orientar el rayo luminoso. Difusor de policarbonato color anís. Versión Dark Light con difusor, no orientable, en aluminio purísimo 99,99% abrillantado en conformidad con la normativa EN 12464. La versión Dark Light difunde la luz incluso en la parte superior aumentando el confort visual. Estructura de aluminio extrudido. Detalles de policarbonato transparente. Rosetón en policarbonato color aluminio. Las versiones con 4 lámparas están cableadas para doble encendido separado. **Version LED suministrada con led smd y alimentador electronico incluido.**

Hängeleuchte zur Beleuchtung von Räumen mit diffusem Licht oder direktem Licht (Version DK). Der Diffusor kann um 360° gedreht werden und ermöglicht auf diese Weise die Ausrichtung der Licht strahl. Diffusor aus anisfarbenem Polycarbonat. Version Dark Light mit Diffusor, nicht verstellbar, aus reinem polierten Aluminium 99,99%, gemäß EN 12464. Die Version Dark Light verbreitet das Licht auch im oberen Teil und erhöht somit den Sehkomfort. Struktur aus Aluminiumextrusion. Einzelteile aus transparentem Polykarbonat. Rosette aus alufarbenem Polykarbonat. Die Ausführungen mit 4 Lampen sind für das doppelte getrennte Einschalten verkabelt. **Ausführung LED zum led smd und integriert Versorgungsgerät elektronisch.**



Disponibile in versione Dark Light e installabile in linea continua.

Available in Dark Light version and suitable for continuous-row lighting.

Disponibile en version Dark Light et installable en ligne continue.

Disponibile en version Dark Light y instalable en línea continua.

Version Dark Light verfügbar und die Ausführung ist in Lichtbandversion.

Colore struttura Structure color

Duo 90

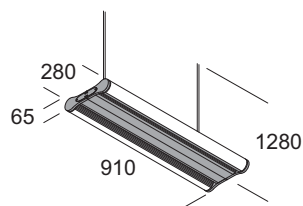

Articolo Item	Colore struttura Structure color		W _{max}	LUMEN	IP	LUMEN/W	C
	CR Codice	AL Code					
● Led duo 90 led-W	74790	74796	37,4	5320	IP20	142	C
● duo 90S led-W	74800	74806	68,8	9380	IP20	136	C
● Led DM duo 90S DM led-W	74810	74816	68,8	9380	IP20	136	C
● Led EM duo 90 EM led-W	74820	74826	37,4	5320	IP20	142	C
● duo 90S EM led-W	74830	74836	68,8	9380	IP20	136	C
● Led duo 90 led-N	74840	74846	37,4	5320	IP20	142	C
● duo 90S led-N	74850	74856	68,8	9380	IP20	136	C
● Led DM duo 90S DM led-N	74860	74866	68,8	9380	IP20	136	C
● Led EM duo 90 EM led-N	74870	74876	37,4	5320	IP20	142	C
● duo 90S EM led-N	74880	74886	68,8	9380	IP20	136	C
EL duo 90/2x39 EL	78600	78606	2x39	7000	IP20	90	A
duo 90/4x39 EL	78640	78646	4x39	14000	IP20	90	B
DM duo 90/4x39 DM	79220	79226	4x39	14000	IP20	90	B
EM duo 90/2x39 EM	70290	70296	2x39	7000	IP20	90	A
duo 90/4x39 EM	70300	70306	4x39	14000	IP20	90	B

Colore struttura Structure color

● Nuova versione New version

CR

Alluminio brillantato (effetto cromato) Shined aluminium (chrome effect)

AL

Alluminio anodizzato Oxided aluminium

Led Equipaggiata con led 3000K - Equipped with led 3000K

Led Equipaggiata con led 4000K - Equipped with led 4000K

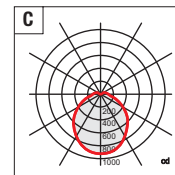
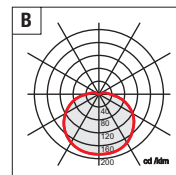
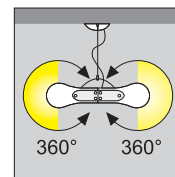
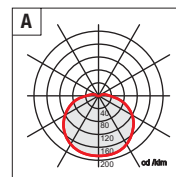
Led DM Led DM DM Dimmerabile PUSH/DALI
Dimmable PUSH/DALI (info page10)Led EM Led EM EM Emergenza (SA) 1h di serie - 3h a richiesta
Emergency 1h standard - 3h on request

Duo 120

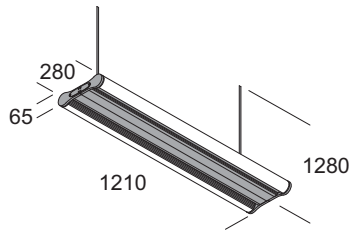

Colore struttura Structure color

Articolo Item	Colore struttura Structure color		W _{max}	Icona	LUMEN	Icona	LUMEN/W	Icona
	CR	AL						
	Codice Code							
● Led duo 120 led-W	74890	74896	50	led	7240	IP20	⊕	145 C
● duo 120S led-W	74900	74906	91,6	led	12520	IP20	⊕	137 C
● Led DM duo 120S DM led-W	74910	74916	91,6	led	12520	IP20	⊕	137 C
● Led EM duo 120 EM led-W	74920	74926	50	led	7240	IP20	⊕	145 C
● duo 120S EM led-W	74930	74936	91,6	led	12520	IP20	⊕	137 C
● Led duo 120 led-N	74940	74946	50	led	7240	IP20	⊕	145 C
● duo 120S led-N	74950	74956	91,6	led	12520	IP20	⊕	137 C
● Led DM duo 120S DM led-N	74960	74966	91,6	led	12520	IP20	⊕	137 C
● Led EM duo 120 EM led-N	74970	74976	50	led	7240	IP20	⊕	145 C
● duo 120S EM led-N	74980	74986	91,6	led	12520	IP20	⊕	137 C
EL duo 120/2x54 EL	78610	78616	2x54	G5	10000	IP20	⊕	93 A
duo 120/4x54 EL	78650	78656	4x54	G5	20000	IP20	⊕	93 B
DM duo 120/4x54 DM	79240	79246	4x54	G5	20000	IP20	⊕	93 B
EM duo 120/2x54 EM	70040	70046	2x54	G5	10000	IP20	⊕	93 A
duo 120/4x54 EM	70060	70066	4x54	G5	20000	IP20	⊕	93 B

Colore struttura Structure color

● Nuova versione New version

CR
Alluminio brillantato (effetto cromato) Shined aluminium (chrome effect)

AL
Alluminio anodizzato Oxided aluminium

Led Equipaggiata con led 3000K - Equipped with led 3000K

Led Equipaggiata con led 4000K - Equipped with led 4000K

Led DM **Led DM** **DM** Dimmerabile PUSH/DALI
Dimmable PUSH/DALI (info page10)

Led EM **Led EM** **EM** Emergenza (SA) 1h di serie - 3h a richiesta
Emergency 1h standard - 3h on request

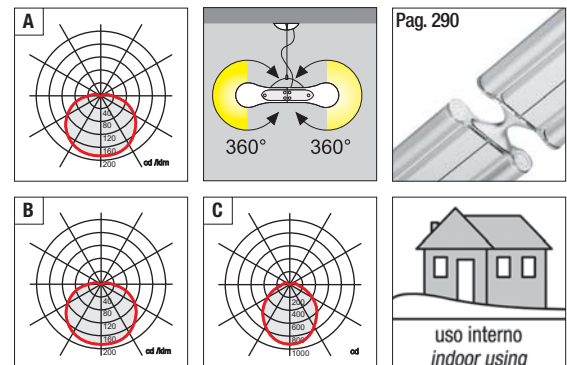

Duo 150

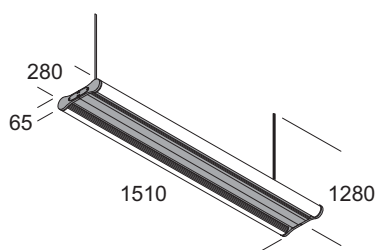

Articolo Item	Colore struttura Structure color		W _{max}	LUMEN	LUMEN/W
	CR	AL			
	Codice Code				
● Led duo 150 led-W	75060	75066	62,4	8940	143
● duo 150S led-W	75070	75076	114,6	15640	136
● Led DM duo 150S DM led-W	75080	75086	114,6	15640	136
● Led EM duo 150 EM led-W	75090	75096	62,4	8940	143
● duo 150S EM led-W	75100	75106	114,6	15640	136
● Led duo 150 led-N	75110	75116	62,4	8940	143
● duo 150S led-N	75120	75126	114,6	15640	136
● Led DM duo 150S DM led-N	75130	75136	114,6	15640	136
● Led EM duo 150 EM led-N	75140	75146	62,4	8940	143
● duo 150S EM led-N	75150	75156	114,6	15640	136
EL duo 150/2x80 EL	78620	78626	2x80	14000	87
duo 150/4x80 EL	78660	78666	4x80	28000	87
DM duo 150/4x80 DM	79260	79266	4x80	28000	87
EM duo 150/2x80 EM	70050	70056	2x80	14000	87
duo 150/4x80 EM	70070	70076	4x80	28000	87

Colore struttura Structure color

● Nuova versione New version

CR
Alluminio brillantato (effetto cromato) Shined aluminium (chrome effect)

AL
Alluminio anodizzato Oxided aluminium

Led Equipaggiata con led 3000K - Equipped with led 3000K

Led Equipaggiata con led 4000K - Equipped with led 4000K

Led DM **Led DM** **DM** Dimmerabile PUSH/DALI
Dimmable PUSH/DALI (info page10)

Led EM **Led EM** **EM** Emergenza (SA) 1h di serie - 3h a richiesta
Emergency 1h standard - 3h on request

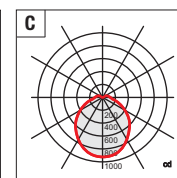
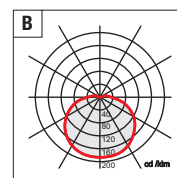
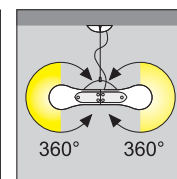
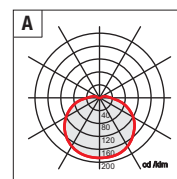

Colore struttura Structure color

DuoDK 90

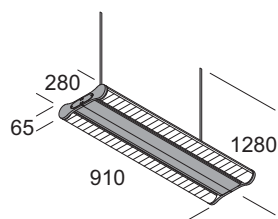

Articolo Item	Colore struttura Structure color		W _{max}	G5	LUMEN	IP	LUMEN/W	A
	CR	AL						
	Codice	Code						
EL duoDK 90/2x39 EL	78608	78609	2x39	G5	7000	IP20	90	A
	78648	78649	4x39	G5	14000	IP20	90	A
DM duoDK 90/4x39 DM	79228	79229	4x39	G5	14000	IP20	90	A
EM duoDK 90/2x39 EM	70298	70299	2x39	G5	7000	IP20	90	A
	70308	70309	4x39	G5	14000	IP20	90	A

DuoDK 120

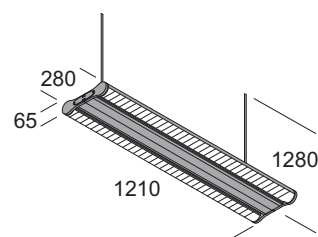

EL duoDK 120/2x54 EL	78618	78619	2x54	G5	10000	IP20	93	A
	78658	78659	4x54	G5	20000	IP20	93	A
DM duoDK 120/4x54 DM	79248	79249	4x54	G5	20000	IP20	93	A
EM duoDK 120/2x54 EM	70048	70049	2x54	G5	10000	IP20	93	A
	70068	70069	4x54	G5	20000	IP20	93	A

DuoDK 150

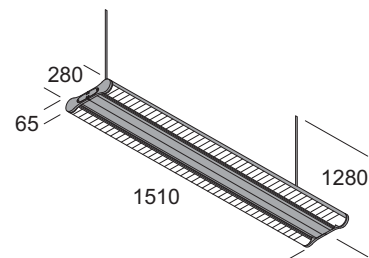

EL duoDK 150/2x80 EL	78628	78629	2x80	G5	14000	IP20	87	A
	78668	78669	4x80	G5	28000	IP20	87	A
DM duoDK 150/4x80 DM	79268	79269	4x80	G5	28000	IP20	87	A
EM duoDK 150/2x80 EM	70058	70059	2x80	G5	14000	IP20	87	A
	70078	70079	4x80	G5	28000	IP20	87	A

Colore struttura Structure color

CR
Alluminio brillantato (effetto cromato) Shined aluminium (chrome effect)

AL
Alluminio anodizzato Oxided aluminium

DM Dimmerabile PUSH/DALI
Dimmable PUSH/DALI (info page10)

EM Emergenza (SA) 1h di serie – 3h a richiesta
Emergency 1h standard – 3h on request

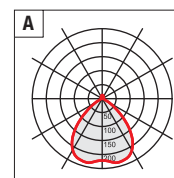
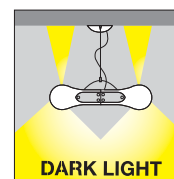



360 LC

Tutte le versioni Duo, Mono e Split, sospensioni applique e plafoniere, sono installabili in linea continua. La configurazione della linea continua è semplificata dalla possibilità di aggiungere un kit di cablaggio ad ogni apparecchio. Gli accessori che compongono i kit e le connessioni elettriche sono già installati sugli apparecchi rendendo la loro installazione semplice e rapida.

All versions Duo, Mono e Split, suspensions wall lights and ceiling lamps are suitable for continuous-row lighting system. This version is simplified from possibility of adding a cabling kit to each fitting. Accessories and electrical connections included in the kit are already fixed up on fitting, making quick and easier their installation.

Toutes les versions Duo, Mono e Split, les suspensions, les appliques et les plafonniers peuvent être installés en ligne continue. La configuration de la ligne continue est simplifiée par la possibilité d'ajouter un kit de câblage à chaque appareil. Les accessoires qui composent les kits et les branchements électriques sont déjà montés sur les appareils en facilitant et accélérant leur installation.

Todas las versiones Duo, Mono e Split, suspensiones aplique y plafones, se pueden instalar en línea continua. La configuración de la línea continua es simplificada por la posibilidad de añadir un kit de cableado a cada aparato. Los accesorios que componen los kits y las conexiones eléctricas ya están instaladas en los aparatos de modo que su instalación sea simple y rápida.

Alle Versionen Duo, Mono e Split, Hängeleuchten, Wandleuchten und Deckenleuchten sind in kontinuierlicher Linie installierbar. Die Gestaltung der kontinuierlichen Linie wird durch die Möglichkeit des Hinzufügens eines Kabelsatzes für jedes Gerät, vereinfacht. Die den Satz bildenden Zubehörteile, sowie die elektrischen Anschlüsse sind zur leichten und schnellen Installation, schon auf den Geräten montiert.

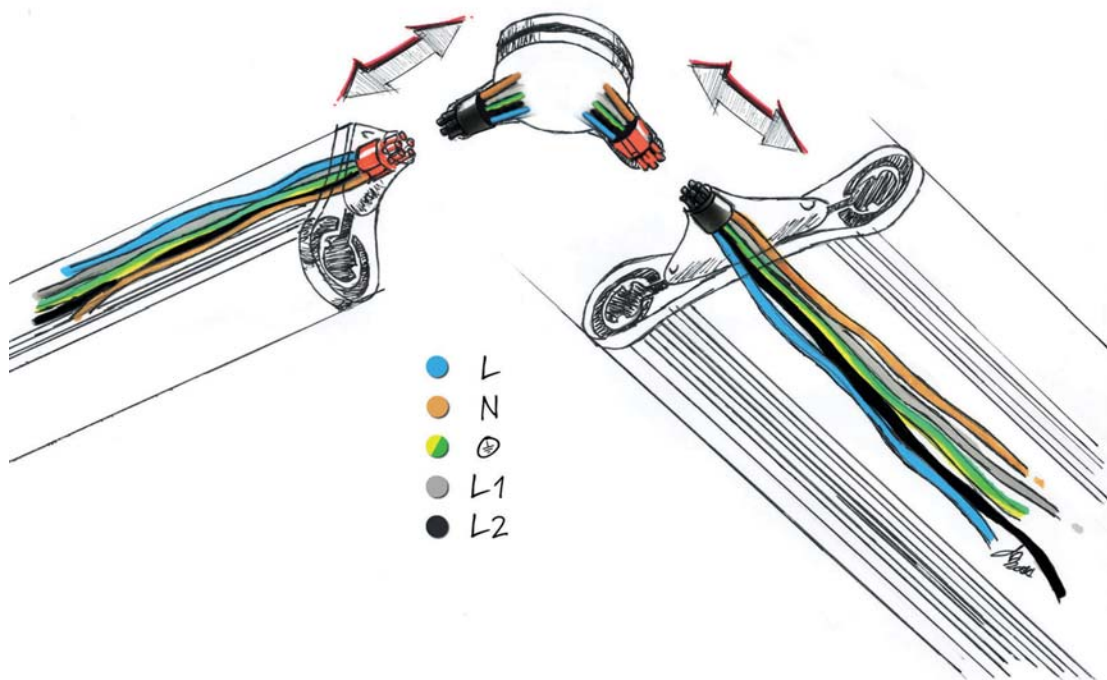

Massima potenza per ogni allacciamento elettrico: 2000w cavo 1,5mmq.
 Max power for each electrical connection: 2000w, wire 1,5 mmq.
 Puissance maximale pour chaque branchement électrique : 2000w câble 1,5mm².
 Potencia máxima para cada conexión eléctrica: 2000w cable 1,5mm²
 Maximale Leistung pro elektrische Verbindung: 2000w Kabel 1,5mmq

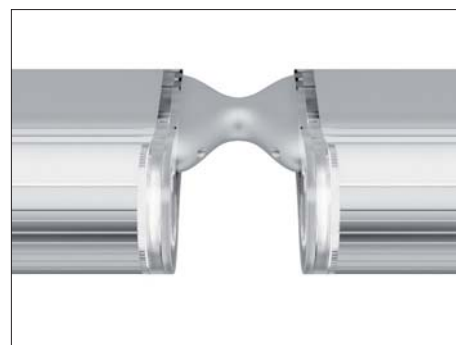







Ad ogni apparecchio deve essere abbinato il codice del kit desiderato. I codici e i prezzi dei kit sono da aggiungere a quelli degli apparecchi. Esempio configurazione linea continua: 78606 (codice apparecchio) + LC-MF (codice kit linea continua).

Each fitting must be linked to the desired kit code. Prices and kit codes have to be added to those of fittings. Example of continuous-row lighting system: 78606 (fitting code)+ LC-MF (continuous-row lighting system kit code)

Le code du kit souhaité doit être associé à chaque appareil. Les codes et les prix des kits sont à ajouter à ceux des appareils. Exemple de configuration en ligne continue: 78606 (code appareil) + LC-MF (code kit ligne continue).

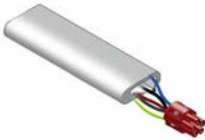
A cada aparato se tiene que combinar el código del kit deseado. Los códigos y los precios de los kits han de sumarse a los de los aparatos. Ejemplo de configuración línea continua: 78606 (código aparato) + LC-MF (código kit línea continua).

Jedem Gerät muss gewünschte Satzkodierung zugewiesen werden. Die Kodierungen und die Preise der Sätze müssen jenen der Geräte hinzugefügt werden. Beispiel der Gestaltung einer kontinuierlichen Linie: 78606 (Gerätkodierung) + LC-MF (Satzkodierung kontinuierliche Linie).

		Articolo <i>Item</i>	Codice <i>Code</i>
	Kit cablaggio centrale. <i>Central cabling kit.</i> <i>Kit câblage centrale.</i> <i>Kit cableado central.</i> <i>Kabelsatz für zentrale Lampe.</i>	cablaggio MF	LC-MF
	Kit con un attacco maschio elettrificato. <i>Kit with one male wired connector.</i> <i>Kit avec une fixation mâle électrifiée.</i> <i>Kit con una unión macho electrificada.</i> <i>Kit mit ein elektrifizierter Zapfenanschluss.</i>	cablaggio M	LC-M
	Kit con un attacco femmina elettrificato. <i>Kit with one female wired connector.</i> <i>Kit avec une fixation femelle électrifiée.</i> <i>Kit con una unión hembra electrificada.</i> <i>Kit mit ein elektrifizierter Nutanschluss.</i>	cablaggio F	LC-F
	Kit con un attacco femmina meccanico e un maschio elettrificato. <i>Kit with one female mechanic connector and one male wired.</i> <i>Kit avec une fixation femelle mécanique et une mâle électrifiée.</i> <i>Kit con una unión hembra solo mecánico y una macho electrificada.</i> <i>Kit mit ein Nutanschluss mechanisch und ein elektrifizierter Zapfenanschluss.</i>	cablaggio MX	LC-MX
	Kit con un attacco femmina elettrificato e un maschio meccanico. <i>Kit with one female wired connector and one male mechanic.</i> <i>Kit avec une fixation femelle électrifiée et une mâle mécanique.</i> <i>Kit con una unión hembra electrificada y una macho mecánico.</i> <i>Kit mit ein elektrifizierter Nutanschluss und Zapfenanschluss mechanisch.</i>	cablaggio FX	LC-FX
	Kit rosone con cavo 150 cm. <i>Top cover kit with wire 150 cm long.</i> <i>Kit patère avec câble de 150 cm.</i> <i>Kit de rosetón con un cable de 150 cm.</i> <i>Rosette-Kitt mit Kabel 150 cm</i>	kit rosone 150 kit rosone 300	LC-R150 LC-R300

Giunto elettrificato



LC-G2

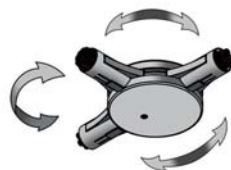

LC-G3

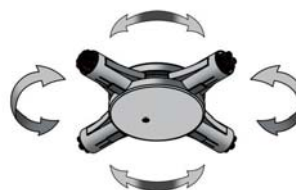

LC-G4

giunto 2 LC-G2

giunto 3 LC-G3

giunto 4 LC-G4

Connettore maschio
Male connectorConnettore femmina
Female connector

REsempi
Example

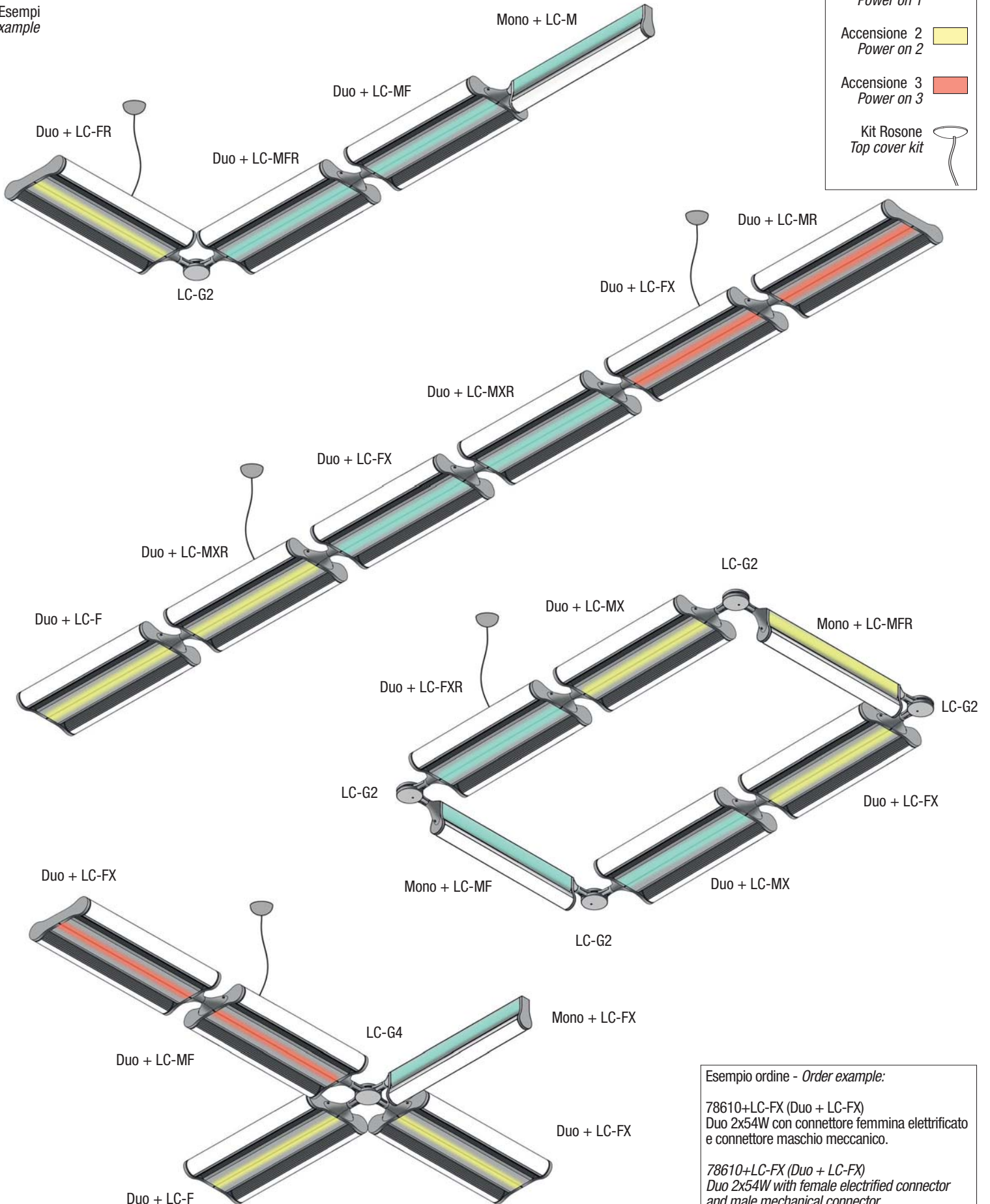

Esempio ordine - Order example:
 78610+LC-FX (Duo + LC-FX)
 Duo 2x54W con connettore femmina elettrificato e connettore maschio meccanico.
 78610+LC-FX (Duo + LC-FX)
 Duo 2x54W with female electrified connector and male mechanical connector.

14 applique interni/esterni
wall lights indoor/outdoor

150 plafoniere interni/esterni
ceiling bowls indoor/outdoor

248 testataletto
bed head units

258 sospensioni
suspensions

344 lampade
lamps

384 lampioni ed incassi
bollards & recessed lights

450 indice
index



Filo IP65

Lampada a sospensione IP65 per illuminazione di ambienti con luce diretta. Diffusore in policarbonato colore anice. Struttura in alluminio estruso con particolari in pressofusione di alluminio, verniciatura in polvere poliestere con trattamento di fosfatazione. Viti in acciaio inox. Guarnizioni in silicone. Rosone in pressofusione di alluminio. **Versione LED equipaggiata con led smd e alimentatore elettronico incorporato.**

Suspension lamp IP65 to illuminate with direct light. Diffuser in polycarbonate colour anise. Structure made in extruded aluminium and die casting aluminium parts. Polyester paint with phosphate treatment. Inox steel screws. Gasket in silicone rubber. Top cover made die casting aluminium. **LED version equipped with smd led and electronic driver included.**

Lampe à suspension IP65 pour éclairage avec lumière directe. Diffuseur en polycarbonate couleur anis. Structure réalisée en extrusion d'aluminium avec parties en fonte d'aluminium. Vernis polyester traitement de phosphatation. Vis en acier inox. Joint en gomme de silicone. Patère en fonte d'aluminium. **Version LED équipée avec led smd et ballast électronique incorporé.**

Lámpara de suspensión IP65 para iluminación de ambientes con luz directa. Difusor de policarbonato color anís. Estructura de aluminio extrudido con detalles fundidos a presión de aluminio, pintura en polvo poliéster con tratamiento de fosfatación. Tornillos de acero inoxidable. Junta de protección de silicona. Rosetón fundido a presión de aluminio. **Version LED suministrada con led smd y alimentador electrónico incluido.**

Hängeleuchte IP65 zur Beleuchtung von Räumen mit direktem Licht. Diffusor aus anisfarbenem Polykarbonat. Struktur aus Aluminium Extrusion mit Einzelteilen aus Aludruckguss, Lackierung aus Polyesterpulver mit Phosphatierung. Schrauben aus rostfreiem Stahl. Silikondichtungen. Rosette aus Aludruckguss. **Ausführung LED zum led smd und integriert Versorgungsgerät elektronisch.**

Filo IP65

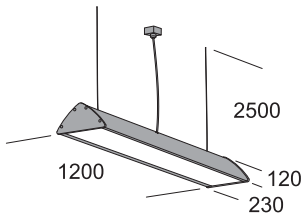

Colore struttura Structure color

Articolo Item	Colore struttura Structure color				W _{max}		LUMEN		LUMEN/W		
	AT	BI	GR	RU							Codice Code
● Led filo IP65 led-W	75167	75161	75166	75168	91,6	led	12520	IP65		137	B
● Led DM filo IP65 DM led-W	75177	75171	75176	75178	91,6	led	12520	IP65		137	B
● Led filo IP65 led-N	75187	75181	75186	75188	91,6	led	12520	IP65		137	B
● Led DM filo IP65 DM led-N	75197	75191	75196	75198	91,6	led	12520	IP65		137	B
● EL filo IP65 EL	77207	77201	77206	77208	2x54	G5	10000	IP65		93	A
● EM filo IP65 EM	70287	70281	70286	70288	2x54	G5	10000	IP65		93	A

Colore struttura Structure color

● Nuova versione New version

AT RAL 7016 Antracite gofrato Embossed anthracite	BI RAL 9016 Bianco gofrato Embossed white	GR RAL 9006 Grigio gofrato Embossed grey	● RU Ruggine Rust
--	--	---	-----------------------------

Led Equipaggiata con led 3000K - Equipped with led 3000K

Led Equipaggiata con led 4000K - Equipped with led 4000K

Led DM **Led DM** Dimmerabile PUSH/DALI
Dimmable PUSH/DALI (info page10)

EM Emergenza (SA) 1h di serie – 3h a richiesta
Emergency 1h standard – 3h on request

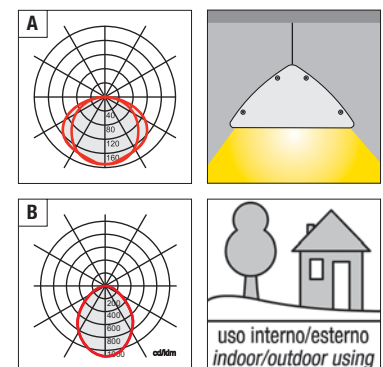



Flash

Serie di lampade composta da faretto orientabili. Struttura in policarbonato trasparente con rosone in metallo bianco opaco ral 9016 o colore alluminio ral 9006. **Equipaggiata con led COB e alimentatore elettronico incorporato. Lente ad emissione stretta 25° o larga 40°.**

Range of light composed by adjustable spot. Structure made in transparent polycarbonate with matt white painted metal top cover ral 9016 or aluminium painted metal top cover ral 9006. **Equipped with COB led and electronic driver included. Emission lens with narrow-angle 25° or wide-angle 40°.**

Collection de lampes réalisé avec projecteurs réglables. Structure en polycarbonate transparent avec patère en métal verni blanc opaque ral 9016 ou en métal verni couleur aluminium ral 9006. **Equipée avec led COB et ballast électronique incorporé. Lentille pour lumière diffuse étroit 25° ou large 40°.**

Serie de lámparas compuestas por proyectores giratorios. Estructura en policarbonato transparente con rosetón de metal pintado blanco opaco ral 9016 o pintado color aluminio ral 9006. **Suministrada con led COB y alimentador electronico incluido. Lente con haz estrecho de 25° o haz amplio de 40°.**

Eine Schwenkbare serie Spotlight. Struktur aus transparentem Polycarbonat mit Metall Frame weiß matt RAL 9016 oder RAL 9006 Aluminium Farbe. Rosette aus weiß lackiertem matt RAL 9016 oder Aluminium Farbe RAL 9006. **Ausgestattet mit LED-COB und elektronisches Vorschaltgerät. Objektiv emittierende engen 25 ° oder 40 ° breit.**

Flash S4

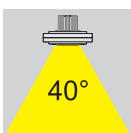
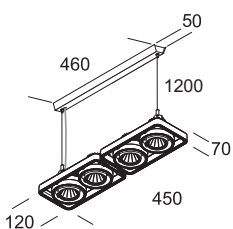

Colore rosone Top cover

Articolo Item	Colore rosone Top cover		W _{max}	LED	LUMEN	IP	LUMEN/W	A
	AL	BI						
	Codice Code							
Led flash S4S-W	75509	75501	28,4	led	3200	IP20	113	A
Led DM flash S4S-W DM	75519	75511	28,4	led	3200	IP20	113	A
Led flash S4S-N	75529	75521	28,4	led	3200	IP20	113	A
Led DM flash S4S-N DM	75539	75531	28,4	led	3200	IP20	113	A
Led flash S4L-W	75549	75541	28,4	led	3200	IP20	113	B
Led DM flash S4L-W DM	75559	75551	28,4	led	3200	IP20	113	B
Led flash S4L-N	75569	75561	28,4	led	3200	IP20	113	B
Led DM flash S4L-N DM	75579	75571	28,4	led	3200	IP20	113	B

Flash SQ

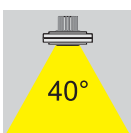
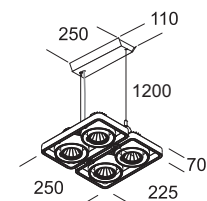

Led flash SQS-W	75589	75581	28,4	led	3200	IP20	113	A
Led DM flash SQS-W DM	75599	75591	28,4	led	3200	IP20	113	A
Led flash SQS-N	75609	75601	28,4	led	3200	IP20	113	A
Led DM flash SQS-N DM	75619	75611	28,4	led	3200	IP20	113	A
Led flash SQL-W	75629	75621	28,4	led	3200	IP20	113	B
Led DM flash SQL-W DM	75639	75631	28,4	led	3200	IP20	113	B
Led flash SQL-N	75649	75641	28,4	led	3200	IP20	113	B
Led DM flash SQL-N DM	75659	75651	28,4	led	3200	IP20	113	B

Colore rosone Top cover

AL RAL 9006
Alluminio Aluminium

BI RAL 9016
Bianco opaco Matt white

Led Equipaggiata con led 3000K - Equipped with led 3000K

Led Equipaggiata con led 4000K - Equipped with led 4000K

Led DM Led DM Dimmerabile PUSH/DALI
Dimmable PUSH/DALI (info page10)

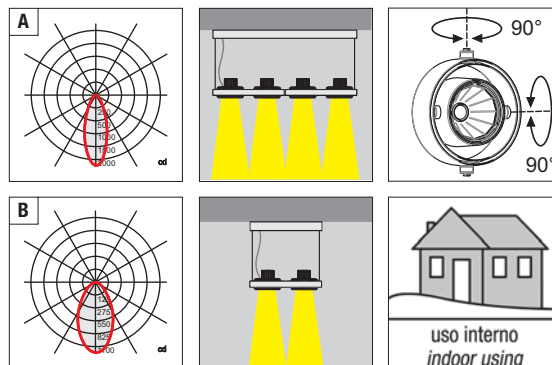



Vog

Serie di lampade composta da faretto orientabili. Struttura in policarbonato trasparente con rosone in metallo bianco opaco ral 9016 o colore alluminio ral 9006. Diffusori in policarbonato opale. **Equipaggiata con led smd e alimentatore elettronico incorporato.**

Range of light composed by adjustable spot. Structure made in transparent polycarbonate with matt white painted metal top cover ral 9016 or aluminium painted metal top cover ral 9006. Diffusers made in opal polycarbonate. **Equipped with smd led and electronic driver included.**

Collection de lampes réalisé avec projecteurs réglables. Structure en polycarbonate transparent avec patère en métal verni blanc opaque ral 9016 ou en métal verni couleur aluminium ral 9006. Diffuseurs en polycarbonate opale. **Equipée avec led smd et ballast électronique incorporé.**

Serie de lámparas compuestas por proyectores giratorios. Estructura en policarbonato transparente con rosetón de metal pintado blanco opaco ral 9016 o pintado color aluminio ral 9006. Difusores de policarbonato opale. **Suministrada con led smd y alimentador electronico incluido.**

Eine Schwenkbare Serie Spotlight. Struktur aus transparentem Polycarbonat mit Metall Frame weiß matt RAL 9016 oder RAL 9006 Aluminium Farbe. Rosette aus weiß lackiertem matt RAL 9016 oder Aluminium Farbe RAL 9006. Diffusoren in opal Polycarbonat. **Ausgestattet mit SMD-LED und elektronisches Vorschaltgerät.**

Vog S4

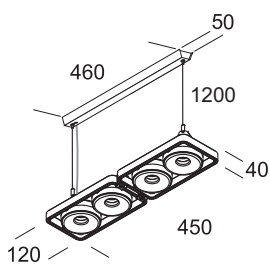

Colore rosone Top cover

Articolo Item	Colore rosone Top cover		W _{max}	led	LUMEN	IP	LUMEN/W	A
	AL	BI						
	Codice	Code						
Led vog S4-W	75669	75661	24	led	3080	IP20	128	A
Led vog S4-N	75679	75671	24	led	3080	IP20	128	A

Vog SQ

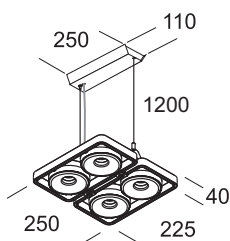

Led vog SQ-W	75689	75681	24	led	3080	IP20	128	A
Led vog SQ-N	75699	75691	24	led	3080	IP20	128	A

Colore rosone Top cover

AL RAL 9006
Alluminio Aluminium

BI RAL 9016
Bianco opaco Matt white

Led Equipaggiata con led 3000K - Equipped with led 3000K

Led Equipaggiata con led 4000K - Equipped with led 4000K

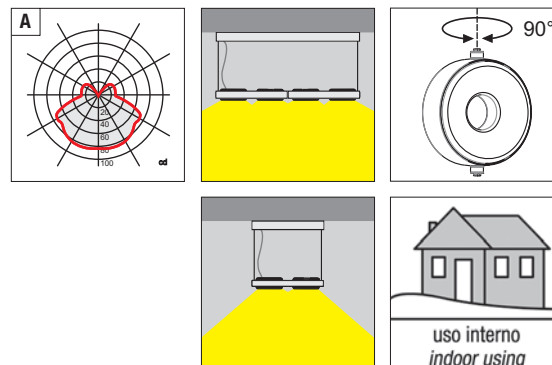



Job

Lampada a sospensione per illuminazione di ambienti con luce diretta e diffusa. Diffusore in acrilico prismatico colore anice verniciato alluminio con coperchio di chiusura trasparente. Montatura in metallo verniciato alluminio ral 9006 opaco. Rosone in policarbonato colore alluminio.

Suspension lamp to illuminate with direct and diffused light. Diffuser made in anise and aluminium painted prismatic acrylic with transparent cover. Frame made in metal painted aluminium ral 9006 matt. Top cover in aluminium coloured polycarbonate.

Lampe à suspension pour éclairage avec lumière directe et diffuse. Diffuseur en acrylique prismatique anis et verni aluminium avec couvercle transparent de fermeture. Monture réalisée en métal verni aluminium ral 9006 opaque. Patère en polycarbonate couleur aluminium.

Lámpara de suspensión para iluminación de ambientes con luz directa y difusa. Difusor de acrílico prismado anís y pintado aluminio con tapa transparente de cierre. Montadura en metal pintado aluminio ral 9006 opaco. Rosetón en policarbonato colore aluminio.

Hängeleuchte zur Beleuchtung von Räumen mit direktem und diffusem Licht. Diffusor aus prismatisch anisfarbenem Acryl und Aluminium lackiertem mit transparent Abdeckung. Fassung aus Aluminium lackiertem Metall Ral 9006 matt. Rosette aus aluminiumfarbenem Polycarbonat.

Job 300

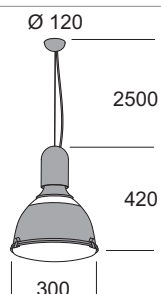

		Colore montatura <i>Frame color</i>							
		AL		W _{max}		LUMEN		LUMEN/W	
Articolo <i>Item</i>		Codice <i>Code</i>							
E27	job 300	71596		1x77	E27	1320	IP20	17	A
EL	job 300 EL	78176		1x42(a)	GX24q-4	3200	IP20	76	A

Job 400

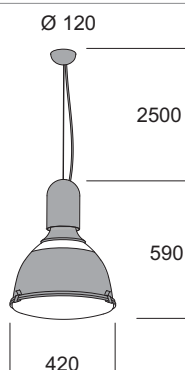

E27	job 400	71606		2x77	E27	2640	IP20	17	A
EL	job 400 EL	78186		2x42(a)	GX24q-4	6400	IP20	76	A
DM	job 400 DM	78206		2x42	GX24q-4	6400	IP20	76	A
EM	job 400 EM	70236		2x42(a)	GX24q-4	6400	IP20	76	A

Job 500

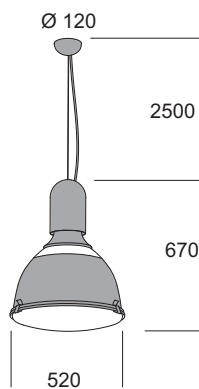

EL	job 500 EL	78216		4x42(a)	GX24q-4	12800	IP20	76	A
DM	job 500 DM	78236		4x42	GX24q-4	12800	IP20	76	A
EM	job 500 EM	70246		4x42(a)	GX24q-4	12800	IP20	76	A

Colore montatura *Frame color*

AL **RAL 9006**
Alluminio *Aluminium*

- DM Dimmerabile PUSH/DALI
Dimmable PUSH/DALI (info page10)
- EM Emergenza (SA) 1h di serie – 3h a richiesta
Emergency 1h standard – 3h on request

(a) Equipaggiato con alimentatore multipotenza per l'utilizzo di lampade da 26W-32W o 42W
Equipped with multi-power ballast to use bulbs of 26W-32W or 42W

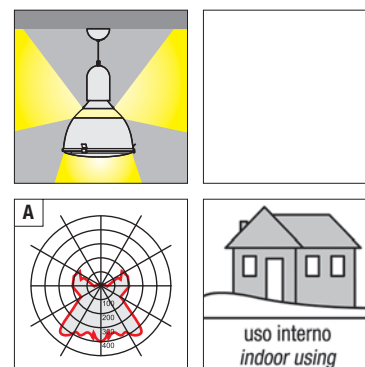



Area

Lampada a sospensione per illuminazione di ambienti con **luce diffusa**. Diffusore in acrilico prismatico colore anice con coperchio di chiusura trasparente. Montatura in metallo verniciato bianco ral 9016 opaco. Rosone in policarbonato bianco. Versione led per illuminazione di ambienti con **luce diretta**. Parabola interna riflettente in alluminio. **Equipaggiata con led smd e alimentatore elettronico incorporato.**

Suspension lamp to illuminate with **diffused light**. Diffuser made in anise prismatic acrylic with transparent cover. Frame made in metal painted matt white ral 9016. Top cover in white polycarbonate. Led version to illuminate with **direct light**. Inside reflector made of aluminium. **Equipped with smd led and electronic driver included.**

Lampe à suspension pour éclairage avec **lumière diffuse**. Diffuseur en acrylique prismatique anis avec couvercle transparent de fermeture. Monture réalisée en métal verni blanc opaque ral 9016. Patère en polycarbonate blanc. Version led pour éclairage avec **lumière directe**. Réflecteur intérieur en aluminium. **Equipée avec led smd et ballast électronique incorporé.**

Lámpara de suspensión para iluminación de ambientes con **luz difusa**. Difusor de acrílico prismatico anís con tapa transparente de cierre. Montadura en metal pintado blanco opaco ral 9016. Rosetón en policarbonato blanco. Version LED para iluminación de ambientes con **luz directa**. Parábola interna reflectante en aluminio. **Suministrada con led smd y alimentador electrónico incluido.**

Hängeleuchte zur Beleuchtung von Räumen mit **diffusem Licht**. Diffusor aus prismatisch anisfarbenem Acryl mit transparent Abdeckung. Fassung aus weiß matt lackiertem Metall Ral 9016. Rosette aus weißfarbenem Polykarbonat. Ausführung LED zur Beleuchtung von Räumen mit **direktem Licht**. Interner Reflex-Parabolspiegel aus Aluminium. **Ausgestattet mit led smd und integriert Versorgungsgerät elektronisch.**

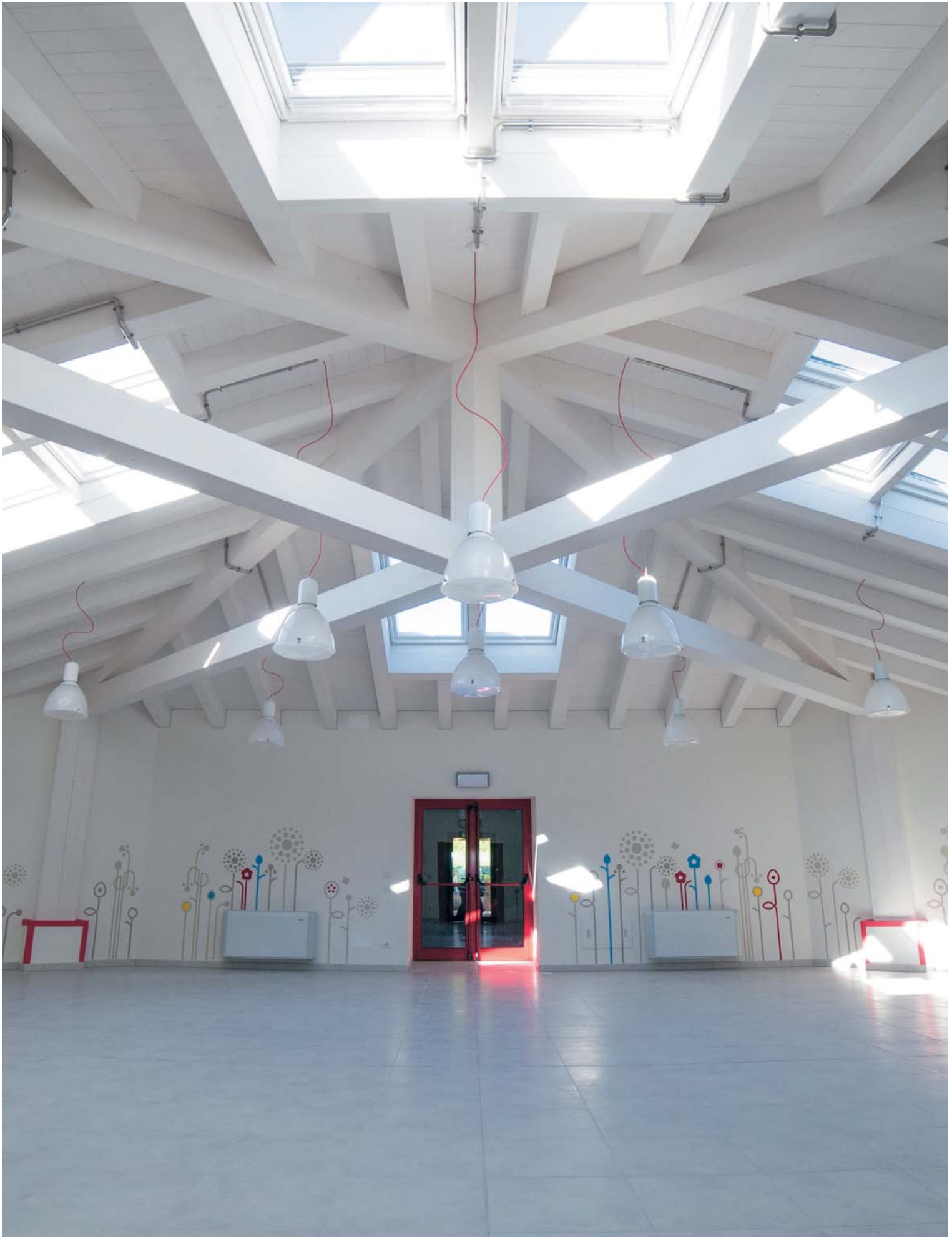

14 applique interni/esterni
wall lights indoor/outdoor

150 plafoniere interni/esterni
ceiling bowls indoor/outdoor

248 testaletto
bed head units

258 sospensioni
suspensions

344 lampade
lamps

384 lampioni ed incassi
bollards & recessed lights

450 indice
index

Colore montatura *Frame color*

Area 300

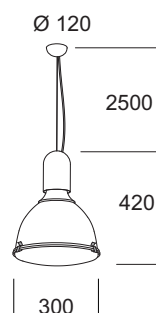

Articolo <i>Item</i>	BI Codice <i>Code</i>	W _{max}		LUMEN		LUMEN/W	
E27 area 300	71571	1x77	E27	1320	IP20	17	A
EL area 300 EL	78031	1x42(a)	GX24q-4	3200	IP20	76	A

Area 400

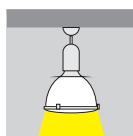
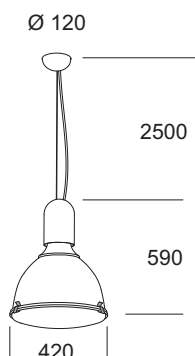

area 400 led-W	75201	23,1	led	3000	IP20	130	B
area 400 led-N	75211	23,1	led	3000	IP20	130	B

E27 area 400	71581	2x77	E27	2640	IP20	17	A
EL area 400 EL	78041	2x42(a)	GX24q-4	6400	IP20	76	A
DM area 400 DM	78061	2x42	GX24q-4	6400	IP20	76	A
EM area 400 EM	70131	2x42(a)	GX24q-4	6400	IP20	76	A

Colore montatura *Frame color*● Nuova versione *New version*

BI **RAL 9016**
Bianco opaco *Matt white*

Equipaggiata con led 3000K - *Equipped with led 3000K*

Equipaggiata con led 4000K - *Equipped with led 4000K*

DM Dimmerabile PUSH/DALI
Dimmable PUSH/DALI (info page10)

EM Emergenza (SA) 1h di serie – 3h a richiesta
Emergency 1h standard – 3h on request

(a) Equipaggiato con alimentatore multipotenza per l'utilizzo di lampade da 26W-32W o 42W
Equipped with multi-power ballast to use bulbs of 26W-32W or 42W

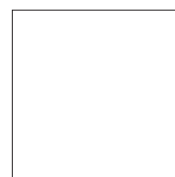
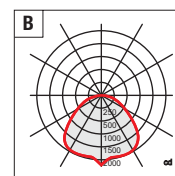
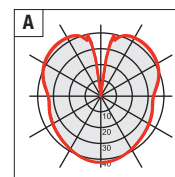

Area 500

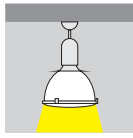
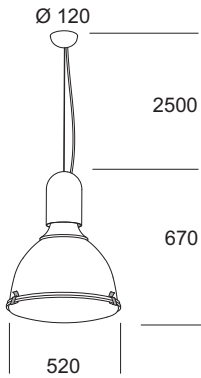

Articolo Item	Colore montatura Frame color		W _{max}		LUMEN		LUMEN/W	
	BI	Codice Code						
● Led area 500 led-W	BI	75221	34,1	led	3550	IP20	⊕	104 B
	BI	75231	34,1	led	3550	IP20	⊕	104 B
● Led area 500 led-N	BI	75231	34,1	led	3550	IP20	⊕	104 B
EL area 500 EL	BI	78071	4x42(a)	GX24q-4	12800	IP20	⊕	76 A
DM area 500 DM	BI	78091	4x42	GX24q-4	12800	IP20	⊕	76 A
EM area 500 EM	BI	70141	4x42(a)	GX24q-4	12800	IP20	⊕	76 A

Colore Montatura Frame color

● Nuova versione New version

BI RAL 9016
Bianco opaco Matt white

Led Equipaggiata con led 3000K - Equipped with led 3000K

Led Equipaggiata con led 4000K - Equipped with led 4000K

DM Dimmerabile PUSH/DALI
Dimmable PUSH/DALI (info page10)

EM Emergenza (SA) 1h di serie – 3h a richiesta
Emergency 1h standard – 3h on request

(a) Equipaggiato con alimentatore multipotenza per l'utilizzo di lampade da 26W-32W o 42W
Equipped with multi-power ballast to use bulbs of 26W-32W or 42W

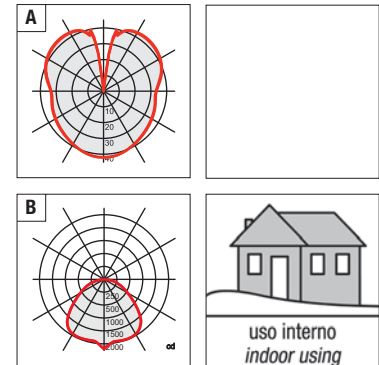

14 applique interni/esterni
wall lights indoor/outdoor

150 plafoniere interni/esterni
ceiling bowls indoor/outdoor

248 testate
bed head units

258 sospensioni
suspensions

344 lampade
lamps

384 lampioni ed incassi
bollards & recessed lights

450 indice
index



Moon

Lampada a sospensione per illuminazione di ambienti con luce diretta. Diffusore in alluminio verniciato bianco opaco o nero opaco. Tutte le versioni hanno la superficie interna verniciata bianca. Rosone in policarbonato colore bianco opaco. **Versione LED equipaggiata con led smd e alimentatore elettronico incorporato.**

Suspension lamp to illuminate with direct light. Diffuser made in painted aluminium colour matt white or matt black. All versions have white painted inside surface. Top cover made in matt white polycarbonate. **LED version equipped with smd led and electronic driver included.**

Lampe à suspension pour éclairage avec lumière directe. Diffuseur réalisé en aluminium verni blanc opaque ou noir opaque. Toutes les versions ont la surface intérieure blanche. Patère en polycarbonate blanc satiné. **Version LED équipée avec led smd et ballast électronique incorporé.**

Lámpara de suspensión para iluminación de ambientes con luz directa. Difusor de aluminio pintado blanco opaco o negro opaco. Todas le versiones tienen la superficie interna blanca. Rosetón en policarbonato color blanco opaco. **Version LED suministrada con led smd y alimentador electrónico incluido.**

Hängeleuchte zur Beleuchtung von Räumen mit direktem Licht. Diffusor aus mattweiß oder mattschwarz lackiertem Aluminium. Alle Versionen haben weiße Innenfläche. Rosette aus mattweißem Polycarbonat. **Ausführung LED zum led smd und integriert Versorgungsgerät elektronisch.**

Moon

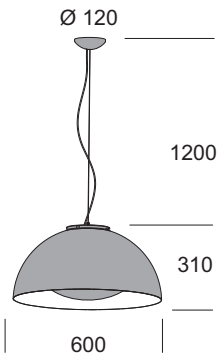

Colore diffusore Diffuser color

Articolo Item	Colore diffusore Diffuser color		W _{max}	E27	LUMEN	IP	LUMEN/W	A
	BI Codice	NE Code						
E27 moon	71651	71657	2x77	E27	2640	IP20	17	A
● Led moon led-W	75241	75247	34,1	led	3550	IP20	104	A
● Led DM moon DM led-W	75251	75257	34,1	led	3550	IP20	104	A
● Led moon led-N	75261	75267	34,1	led	3550	IP20	104	A
● Led DM moon DM led-N	75271	75277	34,1	led	3550	IP20	104	A
EL moon EL	79471	79477	2x42(a)	GX24q-4	6400	IP20	76	A
DM moon DM	79491	79497	2x42	GX24q-4	6400	IP20	76	A



Colore diffusore Diffuser color

● Nuova versione New version

BI RAL 9016 Bianco opaco *Matt white*
NE RAL 9005 Nero opaco *Matt black*

Led Equipaggiata con led 3000K - *Equipped with led 3000K*

Led Equipaggiata con led 4000K - *Equipped with led 4000K*

Led DM **Led DM** **DM** Dimmerabile PUSH/DALI
Dimmable PUSH/DALI (info page10)

(a) Equipaggiato con alimentatore multipotenza per l'utilizzo di lampade da 26W-32W o 42W
Equipped with multi-power ballast to use bulbs of 26W-32W or 42W

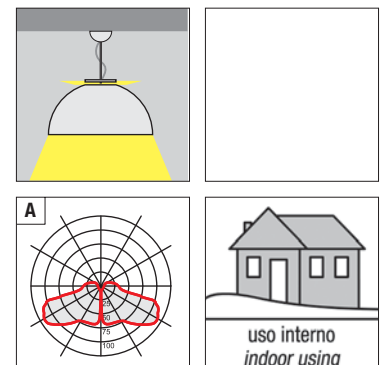



Solarium led

Lampada a sospensione per illuminazione di ambienti con luce diretta. Diffusore in vetro soffiato opale triplex lucido. Struttura e rosone in metallo verniciato o con finitura galvanica. Cavo di alimentazione ricoperto in cotone. **Equipaggiata con LED smd e alimentatore elettronico incorporato.**

Suspension lamp to illuminate with direct light. Diffuser made in blown shiny opal triplex glass. Structure and top cover made in painted metal or with galvanic finish. Feeding wire cotton covered. **Equipped with smd LED and electronic driver included.**

Lampe à suspension pour éclairage avec lumière directe. Diffuseur en verre soufflé opale triplex brillant. Structure et patère réalisés en métal vernie ou avec finition galvanique. Fil d'alimentation revêtis en coton. **Equipée avec LED smd et ballast électronique incorporé.**

Lámpara de suspensión para iluminación de ambientes con luz directa. Difusor de vidrio soplado opal triplex brillante. Estructura y rosetón de metal pintado o con acabado galvanico. Cable de alimentación recubierto de algodón. **Suministrada con LED smd y alimentador electronico incluido.**

Hängeleuchte zur Beleuchtung von Räumen mit direktem Licht. Diffusor aus geblasenem Triplex-Opalglas, glänzend. Struktur und Rosette aus lackiertem Metall oder mit galvanischem Finish. Mit Baumwolle verkleidetes Versorgungskabel. **Ausgestattet zum LED smd und integriert Versorgungsgerät elektronisch.**

Solarium led

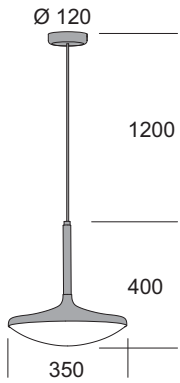

Colore struttura Structure color

Articolo Item	Colore struttura Structure color			W _{max}	Icona	LUMEN	Icona	LUMEN/W	Icona	
	BI	CR	NE							
	Codice Code									
● Led solarium led-W	75281	75280	75287	15,3	led	2070	IP20	⊕	135	A
● LedDIG solarium DIG led-W	75291	75290	75297	15,3	led	2070	IP20	⊕	135	A
● LedDALI solarium DALI led-W	75301	75300	75307	15,3	led	2070	IP20	⊕	135	A
● Led solarium led-N	75311	75310	75317	15,3	led	2070	IP20	⊕	135	A
● LedDIG solarium DIG led-N	75321	75320	75327	15,3	led	2070	IP20	⊕	135	A
● LedDALI solarium DALI led-N	75331	75330	75337	15,3	led	2070	IP20	⊕	135	A

Colore struttura Structure color

● Nuova versione New version

BI RAL 9016 Bianco opaco Matt white	NE RAL 9005 Nero opaco Matt black	CR Cromato Chrome
---	---	-----------------------------

- Led Equipaggiata con led 3000K - Equipped with led 3000K
- Led Equipaggiata con led 4000K - Equipped with led 4000K
- LedDIG LedDIG Dimmerabile PUSH - Dimmable PUSH (info page10)
- LedDALI LedDALI Dimmerabile DALI - Dimmable DALI (info page10)

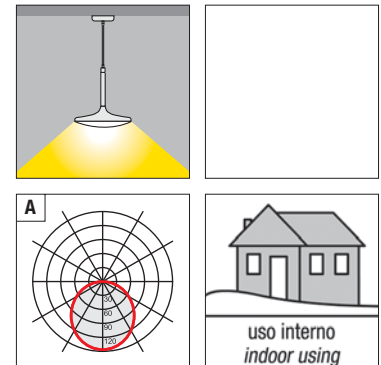



Cosmo

Lampada a sospensione per illuminazione di ambienti con luce diffusa. Diffusore in vetro soffiato opale triplex satinato. Anello trasparente o colorato, in policarbonato autoestinguento. Struttura interna in metallo verniciato bianco ral 9016. **Versione LED equipaggiata con led smd e alimentatore elettronico incorporato.**

Suspension lamp to illuminate with diffused light. Diffuser made in blown satin opal triplex glass. Transparent or coloured ring made in auto-extinguishing polycarbonate. Inside structure made in metal white painted ral 9016. **LED version equipped with smd led and electronic driver included.**

Lampe à suspension pour éclairage avec lumière diffuse. Diffuseur en verre soufflé opale triplex satiné. Anneau transparent ou coloré, réalisé en polycarbonate auto-extinguible. Structure interne réalisée en métal vernie blanc ral 9016. **Version LED équipée avec led smd et ballast électronique incorporé.**

Lámpara de suspensión para iluminación de ambientes con luz difusa. Difusor de vidrio soplado opal triplex satinado. Anillo transparente o de colores, en policarbonato de autoextinción. Estructura interna en metal pintado blanco ral 9016. **Version LED suministrada con led smd y alimentador electrónico incluido.**

Hängeleuchte zur Beleuchtung von Räumen mit diffusem Licht. Diffusor aus geblasenem Triplex-Opalglas, satiniert. Ring transparente oder farbige, aus selbstlöschendem Polycarbonat. Interne Struktur aus weiß lackiertem Metall Ral 9016. **Ausführung LED zum led smd und integriert Versorgungsgerät elektronisch.**



14 applique interni/esterni
wall lights indoor/outdoor

150 plafoniere interni/esterni
ceiling bowls indoor/outdoor

248 testaletto
bed head units

258 sospensioni
suspensions

344 lampade
lamps

384 lampioni ed incassi
bollards & recessed lights

450 indice
index

Colore anello Ring color

Cosmo 300

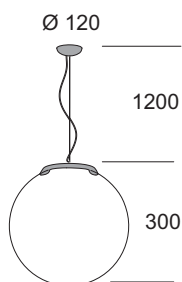

Articolo Item	Colore anello Ring color				W _{max}	LUMEN	IP	LUMEN/W	A	
	BL	GI	RO	TR						
E27 cosmo 300	71615	71612	71613	71610	1x77	E27	1320	IP20	17	A
● Led cosmo 300 led-W	75345	75342	75343	75340	14,9	led	2000	IP20	134	D
● Led cosmo 300 led-N	75355	75352	75353	75350	14,9	led	2000	IP20	134	D
EL cosmo 300 EL	79335	79332	79333	79330	1x42(a)	GX24q-4	3200	IP20	76	B

Cosmo 400

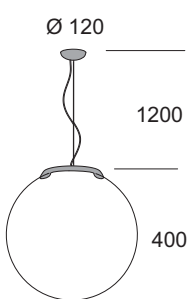

E27 cosmo 400	71625	71622	71623	71620	1x116	E27	2135	IP20	18	A
● Led cosmo 400 led-W	75365	75362	75363	75360	14,9	led	2000	IP20	134	D
● Led cosmo 400 led-N	75375	75372	75373	75370	14,9	led	2000	IP20	134	D
EL cosmo 400 EL/42	79345	79342	79343	79340	1x42(a)	GX24q-4	3200	IP20	76	B
cosmo 400 EL/84	79355	79352	79353	79350	2x42(a)	GX24q-4	6400	IP20	76	C
DM cosmo 400 DM/84	79395	79392	79393	79390	2x42	GX24q-4	6400	IP20	76	C

Cosmo 500

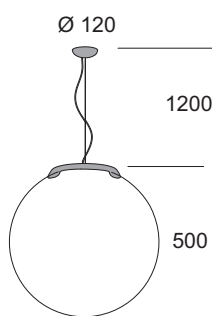

E27 cosmo 500	71635	71632	71633	71630	1x116	E27	2135	IP20	18	A
EL cosmo 500 EL/84	79365	79362	79363	79360	2x42(a)	GX24q-4	6400	IP20	76	C
DM cosmo 500 DM/84	79415	79412	79413	79410	2x42	GX24q-4	6400	IP20	76	C

Colore anello Ring color

● Nuova versione New version

BL RAL 5017 Blu Blue	GI RAL 1023 Giallo Yellow	RO RAL 3000 Rosso Red	TR Trasparente Transparent
--------------------------------	-------------------------------------	---------------------------------	--------------------------------------

● Led Equipaggiata con led 3000K - Equipped with led 3000K

● Led Equipaggiata con led 4000K - Equipped with led 4000K

DM Dimmerabile PUSH/DALI
Dimmable PUSH/DALI (info page10)

(a) Equipaggiato con alimentatore multipotenza per l'utilizzo di lampade da 26W-32W o 42W
Equipped with multi-power ballast to use bulbs of 26W-32W or 42W

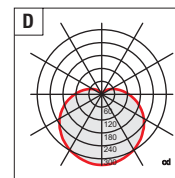
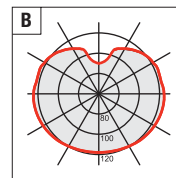
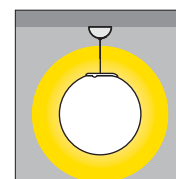
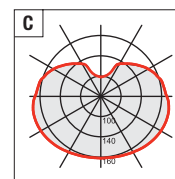
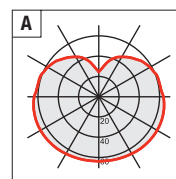

Cosmo 600

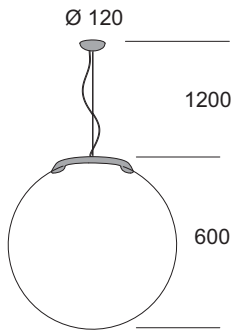

Articolo Item	Colore anello Ring color				W _{max}	E	LUMEN	IP	LUMEN/W	Icon
	BL	GI	RO	TR						
E27 cosmo 600	71645	71642	71643	71640	1x116	E27	2135	IP20	18	A
EL cosmo 600 EL/84	79375	79372	79373	79370	2x42(a)	GX24q-4	6400	IP20	76	C
DM cosmo 600 DM/84	79435	79432	79433	79430	2x42	GX24q-4	6400	IP20	76	C

Kit grappolo

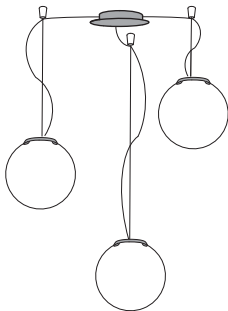

kit grappolo 2	70941	max 2 sospensioni – max 2 fittings.
kit grappolo 3	70951	max 3 sospensioni – max 3 fittings.
kit grappolo 4	70961	max 4 sospensioni – max 4 fittings.

Il kit grappolo è composto da:

- 1 rosone in metallo Ø 160mm. colore bianco opaco.
- sistema di fissaggio in metallo cromato per ogni sospensione.

Le sospensioni vanno acquistate in aggiunta al kit e sono cablate con 1,2mt di cavo.

A richiesta è possibile fornire le sospensioni con cavi più lunghi.

Grappolo kit is composed by:

- 1 top cover Ø 160mm. made in matt white painted metal.
- fixing system made in chrome plated metal for each suspension.

Suspensions must be purchased in addition to the kit and they are equipped with 1,2mt wires long.

By request we can provide suspensions with longer cables.

Colore anello Ring color

BL RAL 5017 Blu Blue	GI RAL 1023 Giallo Yellow	RO RAL 3000 Rosso Red	TR Trasparente Transparent
--------------------------------	-------------------------------------	---------------------------------	--------------------------------------

DM Dimmerabile PUSH/DALI
Dimmable PUSH/DALI (info page10)

(a) Equipaggiato con alimentatore multipotenza per l'utilizzo di lampade da 26W-32W o 42W
Equipped with multi-power ballast to use bulbs of 26W-32W or 42W

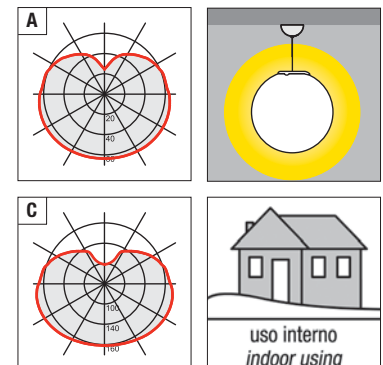

Stilo - Stilo/C

Lampada a sospensione per illuminazione di ambienti con luce diffusa. Diffusore in acrilico opale. Montatura e rosone in metallo cromato o verniciato bianco opaco ral 9016. La sospensione è fornita con una tige diametro 13 mm e lunga 1500 mm che può essere facilmente accorciata ottenendo la misura desiderata. **Versione LED equipaggiata con led smd e alimentatore elettronico incorporato.** Stilo/C è fornita con cavo di sostegno in acciaio, filo elettrico a vista e rosone in policarbonato bianco opaco.

Suspension lamp to illuminate with diffused light. Diffuser made in opal acrylic. Frame and top cover made in chrome plated metal or white matt painted metal ral 9016. Suspension is provided with rod 13mm diameter and length 1500mm and it can easily be shortened to obtain the desired size. **LED version equipped with smd led and electronic driver included.**

Stilo/C is supplied with steel support cable, electric wire in sight and top cover in matt white polycarbonate.

Lampe à suspension pour éclairage avec lumière diffuse. Diffuseur en acrylique opale. Monture et patère réalisés en métal chromé ou vernie blanc opaque ral 9016. La suspension est fournie avec une tige diamètre 13 mm et une longueur de 1500 mm qui peut facilement être raccourci pour obtenir la mesure désirée. **Version LED équipée avec led smd et ballast électronique incorporé.** Stilo/C est fourni avec un câble de soutien en acier, fil électrique en vue et patère en polycarbonate blanc satiné.

Lámpara de suspensión para iluminación de ambientes con luz difusa. Difusor de acrilico opal. Montadura y rosetón en metal cromado o pintado blanco opaco ral 9016. La lámpara es suministrada con caña de suspension 13 mm de diametro y una longitud de 1500 mm, que se puede fácilmente acortar para obtener la medida deseada. **Version LED suministrada con led smd y alimentador electronico incluido.** Stilo/C se suministra con cable de soporte de acero, cables eléctricos a la vista y rosetón en policarbonato color blanco opaco.

Hängeleuchte zur Beleuchtung von Räumen mit diffusem Licht. Diffusor aus opalfarbenem Acryl. Struktur und Rosette aus verchromtem Metall oder mattweiß lackiertem Metall Ral 9016. Diese Leuchten werden mit Rohrpengel 13mm Durchmesser geliefert und Länge von 1500 mm, Rohre die leicht auf die gewünschte Länge gekürzt werden können. **Ausführung LED zum led smd und integriert Versorgungsgerät elektronisch.** Stilo/C ist mit Stahltragseil, Elektrodraht in Sicht geliefert und Rosette in mattweißem Polycarbonat.



Colore struttura Structure color

Stilo 400

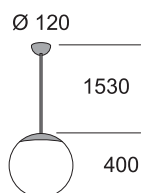

Articolo Item	Colore struttura Structure color		W _{max}		LUMEN		LUMEN/W	
	BI	CR						
	Codice Code							
stilo 400			1x77	E27	1320	IP20		17 A
stilo 400 led-W			23,1	led	3000	IP20		130 A
stilo 400 DM led-W			23,1	led	3000	IP20		130 A
stilo 400 led-N			23,1	led	3000	IP20		130 A
stilo 400 DM led-N			23,1	led	3000	IP20		130 A
stilo 400 EL			2x42(a)	GX24q-4	6400	IP20		76 A
stilo 400 DM			2x42	GX24q-4	6400	IP20		76 A
stilo 400 EM			2x42(a)	GX24q-4	6400	IP20		76 A

Stilo 400/C

NEW

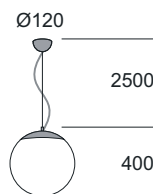

stilo 400/C			1x77	E27	1320	IP20		17 A
stilo 400/C led-W			23,1	led	3000	IP20		130 A
stilo 400/C DM led-W			23,1	led	3000	IP20		130 A
stilo 400/C led-N			23,1	led	3000	IP20		130 A
stilo 400/C DM led-N			23,1	led	3000	IP20		130 A
stilo 400/C EL			2x42(a)	GX24q-4	6400	IP20		76 A
stilo 400/C DM			2x42	GX24q-4	6400	IP20		76 A
stilo 400/C EM			2x42(a)	GX24q-4	6400	IP20		76 A

Colore struttura Structure color

● Nuova versione New version

RAL 9016 Bianco opaco <i>Matt white</i>	CR Cromato <i>Chrome</i>
---	------------------------------------

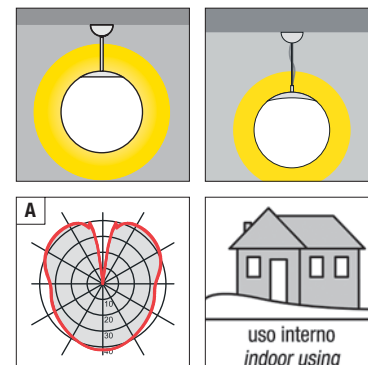
 Equipaggiata con led 3000K - *Equipped with led 3000K* Equipaggiata con led 4000K - *Equipped with led 4000K* Dimmerabile PUSH/DALI
Dimmable PUSH/DALI (info page10) Emergenza (SA) 1h di serie - 3h a richiesta.
Emergency 1h standard - 3h on request(a) Equipaggiato con alimentatore multipotenza per l'utilizzo di lampade da 26W-32W o 42W
Equipped with multi-power ballast to use bulbs of 26W-32W or 42W

Stilo 500

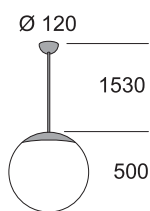

Colore struttura Structure color

Articolo Item	Colore struttura Structure color		W _{max}		LUMEN		LUMEN/W	
	BI	CR						
	Codice Code							
stilo 500			1x116	E27	2135	IP20	18	A
stilo 500 led-W			44,7	led	6000	IP20	134	A
stilo 500 DM led-W			44,7	led	6000	IP20	134	A
stilo 500 led-N			44,7	led	6000	IP20	134	A
stilo 500 DM led-N			44,7	led	6000	IP20	134	A
stilo 500 EL			3x42(a)	GX24q-4	9600	IP20	76	A
stilo 500 DM			3x42	GX24q-4	9600	IP20	76	A
stilo 500 EM			3x42(a)	GX24q-4	9600	IP20	76	A

Stilo 500/C **NEW**

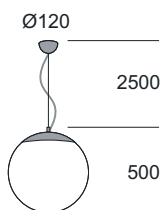

stilo 500/C			1x116	E27	2135	IP20	18	A
stilo 500/C led-W			44,7	led	6000	IP20	134	A
stilo 500/C DM led-W			44,7	led	6000	IP20	134	A
stilo 500/C led-N			44,7	led	6000	IP20	134	A
stilo 500/C DM led-N			44,7	led	6000	IP20	134	A
stilo 500/C EL			3x42(a)	GX24q-4	9600	IP20	76	A
stilo 500/C DM			3x42	GX24q-4	9600	IP20	76	A
stilo 500/C EM			3x42(a)	GX24q-4	9600	IP20	76	A

Colore struttura Structure color

RAL 9016
Bianco opaco *Matt white*

CR
Cromato *Chrome*

Nuova versione New version

Equipaggiata con led 3000K - *Equipped with led 3000K*

Equipaggiata con led 4000K - *Equipped with led 4000K*

Dimmerabile PUSH/DALI
Dimmable PUSH/DALI (info page10)

Emergenza (SA) 1h di serie - 3h a richiesta.
Emergency 1h standard - 3h on request

(a) Equipaggiato con alimentatore multipotenza per l'utilizzo di lampade da 26W-32W o 42W
Equipped with multi-power ballast to use bulbs of 26W-32W or 42W

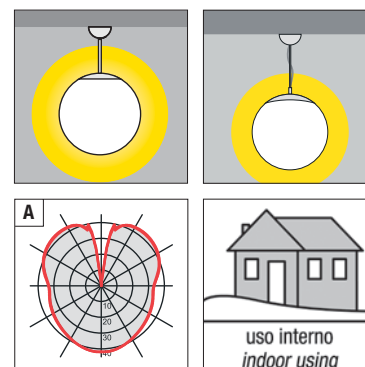

Colore struttura Structure color

Stilo 600

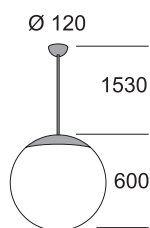

Articolo Item	Colore struttura Structure color		W _{max}		LUMEN		LUMEN/W	
	BI	CR						
	Codice Code							
E27 stilo 600			72341 72340	1x116	E27	2135	IP20	⊕ 18 A
● Led stilo 600 led-W			75781 75780	44,7	led	6000	IP20	⊕ 134 A
● Led DM stilo 600 DM led-W			75791 75790	44,7	led	6000	IP20	⊕ 134 A
● Led stilo 600 led-N			75801 75800	44,7	led	6000	IP20	⊕ 134 A
● Led DM stilo 600 DM led-N			75811 75810	44,7	led	6000	IP20	⊕ 134 A
EL stilo 600 EL			79861 79860	4x42(a)	GX24q-4	12800	IP20	⊕ 76 A
DM stilo 600 DM			79881 79880	4x42	GX24q-4	12800	IP20	⊕ 76 A
EM stilo 600 EM			70551 70550	4x42(a)	GX24q-4	12800	IP20	⊕ 76 A

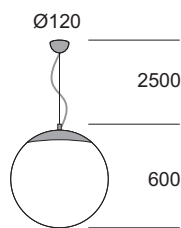
Stilo 600/C **NEW**

E27 stilo 600/C			71041 71040	1x116	E27	2135	IP20	⊕ 18 A
Led stilo 600/C led-W			75901 75900	44,7	led	6000	IP20	⊕ 134 A
Led DM stilo 600/C DM led-W			75911 75910	44,7	led	6000	IP20	⊕ 134 A
Led stilo 600/C led-N			75921 75920	44,7	led	6000	IP20	⊕ 134 A
Led DM stilo 600/C DM led-N			75931 75930	44,7	led	6000	IP20	⊕ 134 A
EL stilo 600/C EL			78281 78280	4x42(a)	GX24q-4	12800	IP20	⊕ 76 A
DM stilo 600/C DM			78291 78290	4x42	GX24q-4	12800	IP20	⊕ 76 A
EM stilo 600/C EM			70881 70880	4x42(a)	GX24q-4	12800	IP20	⊕ 76 A

Colore struttura Structure color

● Nuova versione New version

BI RAL 9016 Bianco opaco <i>Matt white</i>	CR Cromato <i>Chrome</i>
---	------------------------------------

Led Equipaggiata con led 3000K - *Equipped with led 3000K*

Led Equipaggiata con led 4000K - *Equipped with led 4000K*

Led DM **DM** Dimmerabile PUSH/DALI
Dimmable PUSH/DALI (info page10)

EM Emergenza (SA) 1h di serie – 3h a richiesta.
Emergency 1h standard – 3h on request

(a) Equipaggiato con alimentatore multipotenza per l'utilizzo di lampade da 26W-32W o 42W
Equipped with multi-power ballast to use bulbs of 26W-32W or 42W

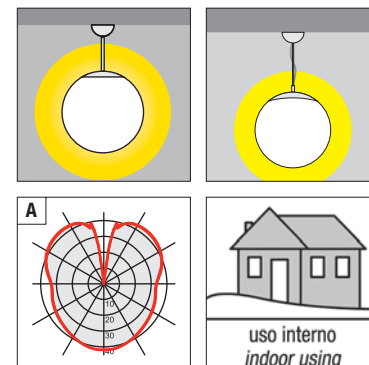



14 applique interni/esterni
wall lights indoor/outdoor

150 plafoniere interni/esterni
ceiling bowls indoor/outdoor

248 testaletto
bed head units

258 sospensioni
suspensions

344 lampade
lamps

384 lampioni ed incassi
bollards & recessed lights

450 indice
index





Asia

Lampada a sospensione per illuminazione di ambienti con luce diretta. Diffusore in metallo verniciato con schermo in policarbonato opale. La versione bianca ha il cavo elettrico rosso, la versione nera ha la superficie interna bianca ed il cavo elettrico bianco. Rosone in metallo verniciato. Le sospensioni 350 e 550 sono fornite con cavi di sostegno in acciaio. **Equipaggiata con led smd e alimentatore elettronico incorporato. La finitura ed il cavo possono cambiare a richiesta del cliente.**

Suspension lamp to illuminate with direct light. Diffuser made in painted metal with opal polycarbonate screen. Version white colour is equipped with red electric cable, version black colour has inside surface painted white and white electric cable. Top cover made in painted metal. The suspensions 350 and 550 are supplied with steel support cables. **Equipped with smd led and electronic driver included. Finish and cable can change based on client request.**

Lampe à suspension pour éclairage avec lumière directe. Diffuseur réalisé en métal verni avec écran en polycarbonate opale. La version blanc est équipée avec câble électrique rouge, la version noire a la surface intérieure blanc et le câble électrique blanc. Patère en métal verni. Les suspensions 350 et 550 sont fournis avec câbles de soutien en acier. **Equipée avec led smd et ballast électronique incorporé. La finition et le câble peuvent changé selon la demande du client.**

Lámpara de suspensión para iluminación de ambientes con luz directa. Difusor en metal pintado y pantalla en policarbonato opale. La versión blanca tiene el cable rojo, la versión negra tiene la superficie interna blanca y el cable blanco. Rosetón en metal pintado. Las suspensiones 350 y 550 se suministran con cables de soporte de acero. **Suministrada con led smd y alimentador electrónico incluido. Acabado y le cable puede cambiar a petición del cliente.**

Pendelleuchte für Beleuchtung Zimmer mit direktem Licht. Diffusor aus lackiertem Metall mit Bildschirm aus Opal Polykarbonat Die weiße Version hat die rote Stromkabel, die schwarze Version hat die innere Oberfläche der weißen und der schwarzen Netzkabel. Rosette aus lackiertem Metall. Die Suspensionen 350 und 550 sind mit Stahlträgerkabel. **Ausgestattet mit SMD-LEDs und elektronische Stromversorgung. Die Farbe und Kabel könne auf die Bedürfnisse des Kunden abgestimmt werden.**

Colore struttura Structure color

Asia 250

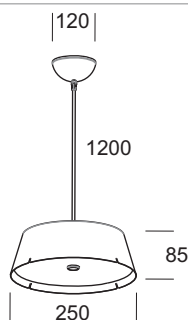

Articolo Item	Colore struttura Structure color		W _{max}	LUMEN	LUMEN/W	A
	BI Codice Code	NE Codice Code				
Led asia 250 led-W	76041	76047	8,33	1090	131	A
Led asia 250 led-N	76051	76057	8,33	1090	131	A

Asia 350

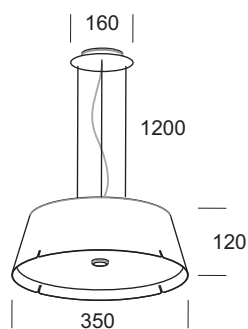

Led asia 350 led-W	76061	76067	15,3	2070	135	A
Led asia 350 led-N	76071	76077	15,3	2070	135	A

Asia 550

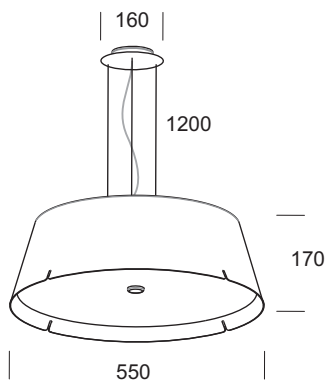

Led asia 550 led-W	76081	76087	34,1	3550	104	A
Led DM asia 550 DM led-W	76091	76097	34,1	3550	104	A
Led asia 550 led-N	76101	76107	34,1	3550	104	A
Led DM asia 550 DM led-N	76111	76117	34,1	3550	104	A

Colore struttura Structure color

BI RAL 9016 Bianco opaco Matt white	NE RAL 9005 Nero opaco Matt black
---	---

Led Equipaggiata con led 3000K - Equipped with led 3000K

Led Equipaggiata con led 4000K - Equipped with led 4000K

Led DM **Led DM** Dimmerabile PUSH/DALI
Dimmable PUSH/DALI (info page10)

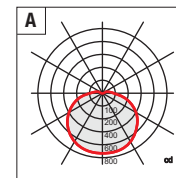
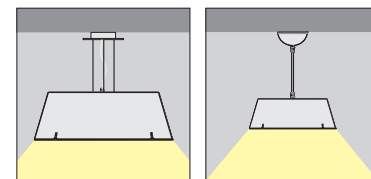



14 applique interni/esterni
wall lights indoor/outdoor

150 plafoniere interni/esterni
ceiling bowls indoor/outdoor

248 testataletto
bed head units

258 sospensioni
suspensions

344 lampade
lamps

384 lampioni ed incassi
bollards & recessed lights

450 indice
index



Open

Lampada a sospensione per illuminazione di ambienti con luce diffusa. Diffusore in vetro soffiato opale triplex lucido. Montatura in metallo verniciato grigio alluminio ral 9006. Rosone in policarbonato colore bianco opaco. Filtro colorato applicabile sui modelli 350 e 450 per ottenere un gradevole effetto colorato sul vetro.

Suspension lamp to illuminate with diffused light. Diffuser made in blown shiny opal triplex glass. Frame made in metal painted grey aluminium ral 9006. Top cover made in matt white polycarbonate. Coloured filter available on models 350 and 450 to obtain nice coloured effects on the glass.

Lampe à suspension pour éclairage avec lumière diffuse. Diffuseur en verre soufflé opale triplex brillant. Monture réalisée en métal vernie aluminium ral 9006. Patère en polycarbonate blanc satiné. Filtre coloré applicable aux modèles 350 et 450 pour obtenir un effet agréable sur le verre.

Lámpara de suspensión para iluminación de ambientes con luz difusa. Difusor de vidrio soplado opal triplex brillante. Montadura en metal pintado gris aluminio ral 9006. Rosetón en policarbonato color blanco opaco. Filtro coloreado aplicable en modelos 350 e 450 para obtener un agradable efecto coloreado en el vidrio.

Hängeleuchte zur Beleuchtung von Räumen mit diffusem Licht. Diffusor aus geblasenem Triplex-Opalglas, glänzend. Fassung aus aluminiumgrau lackiertem Metall Ral 9006. Rosette aus mattweißem Polycarbonat. Farbiger Filter, der für die Modelle 350 und 450 verwendet werden kann, um einen angenehmen Farbeffekt auf dem Glas zu erzielen.

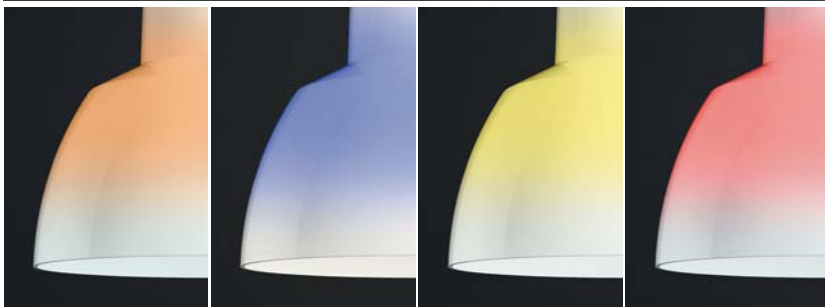



14 applique interni/esterni
wall lights indoor/outdoor

150 plafoniere interni/esterni
ceiling bowls indoor/outdoor

248 testaletto
bed head units

258 sospensioni
suspensions

344 lampade
lamps

384 lampioni ed incassi
bollards & recessed lights

450 indice
index

Colore vetro Glass color

Open 250

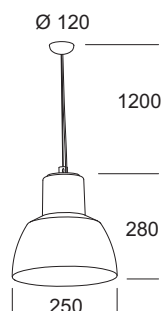

Articolo Item	OP Codice Code	W _{max}		LUMEN		LUMEN/W	
E27 open 250	72231	1x77	E27	1320	IP20	17	A

Open 350

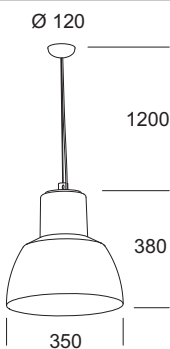

E27 open 350	72241	1x116	E27	2135	IP20	18	A
EL open 350 EL	78991	1x42(a)	GX24q-4	3200	IP20	76	B

Open 450

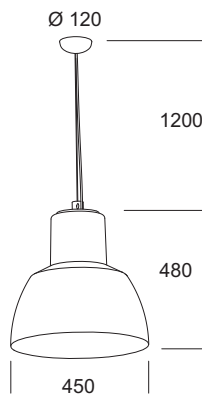

E27 open 450	72251	1x116	E27	2135	IP20	18	A
EL open 450 EL/42	79001	1x42(a)	GX24q-4	3200	IP20	76	B
open 450 EL/84	78101	2x42(a)	GX24q-4	6400	IP20	76	B
DM open 450 DM/84	78151	2x42	GX24q-4	6400	IP20	76	B

Colore vetro Glass color

OP

Opale lucido Shiny opal

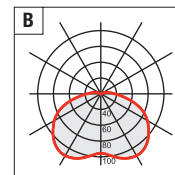
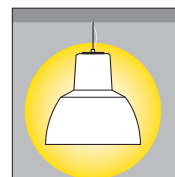
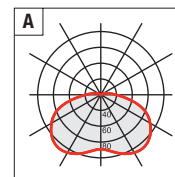
DM Dimmerabile PUSH/DALI
Dimmable PUSH/DALI (info page10)(a) Equipaggiato con alimentatore multipotenza per l'utilizzo di lampade da 26W-32W o 42W
Equipped with multi-power ballast to use bulbs of 26W-32W or 42W

Kit grappolo



Articolo Item	Codice Code	
kit grappolo 2	70941	max 2 sospensioni – max 2 fittings.
kit grappolo 3	70951	max 3 sospensioni – max 3 fittings.
kit grappolo 4	70961	max 4 sospensioni – max 4 fittings.

Il kit grappolo è composto da:

- 1 rosone in metallo Ø 160mm. colore bianco opaco.
- sistema di fissaggio in metallo cromato per ogni sospensione.

Le sospensioni vanno acquistate in aggiunta al kit e sono cablate con 1,2mt di cavo.

A richiesta è possibile fornire le sospensioni con cavi più lunghi.

Grappolo kit is composed by:

- 1 top cover Ø 160mm. made in matt white painted metal.
- fixing system made in chrome plated metal for each suspension.

Suspensions must be purchased in addition to the kit and they are equipped with 1,2mt wires long.

By request we can provide suspensions with longer cables.



CODICE FILTRO - FILTER CODE:

70992

70998

70993

70995

FILTRO - FILTER - FILTRE - FILTRO - FILTER X Open OP 350-450



Nordica

Lampada a sospensione per illuminazione di ambienti con luce diffusa. Diffusore in vetro soffiato opale triplex lucido. Montatura in metallo cromato. Rosone in policarbonato colore bianco opaco.

Suspension lamp to illuminate with diffused light. Diffuser made in blown shiny opal triplex glass. Frame in chrome plated metal. Top cover made in matt white polycarbonate.

Lampe à suspension pour éclairage avec lumière diffuse. Diffuseur en verre soufflé opale triplex brillant. Monture réalisée en métal chromé. Patère en polycarbonate blanc satiné.

Lámpara de suspensión para iluminación de ambientes con luz difusa. Difusor de vidrio soplado opal triplex brillante. Montadura de metal cromado. Rosetón en polycarbonato color blanco opaco.

Hängeleuchte zur Beleuchtung von Räumen mit diffusem Licht. Diffusor aus geblasenem Triplex-Opalglas glänzend. Fassung aus verchromtem Metall. Rosette aus mattweißem Polycarbonat.



Nordica

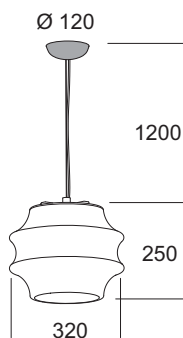

Articolo Item	Colore vetro Glass color		W _{max}		LUMEN		LUMEN/W	
	OP	Codice Code						
E27 nordica		72071	1x116	E27	2135	IP20	18	A

Kit grappolo

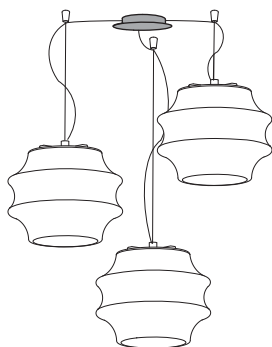

kit grappolo 2	70941	max 2 sospensioni – max 2 fittings.
kit grappolo 3	70951	max 3 sospensioni – max 3 fittings.
kit grappolo 4	70961	max 4 sospensioni – max 4 fittings.

Il kit grappolo è composto da:

- 1 rosone in metallo Ø 160mm. colore bianco opaco.
- sistema di fissaggio in metallo cromato per ogni sospensione.

Le sospensioni vanno acquistate in aggiunta al kit e sono cablate con 1,2mt di cavo.

A richiesta è possibile fornire le sospensioni con cavi più lunghi.

Grappolo kit is composed by:

- 1 top cover Ø 160mm. made in matt white painted metal.
- fixing system made in chrome plated metal for each suspension.

Suspensions must be purchased in addition to the kit and they are equipped with 1,2mt wires long.

By request we can provide suspensions with longer cables.

Colore vetro Glass color

OP
Opale lucido Shiny opal

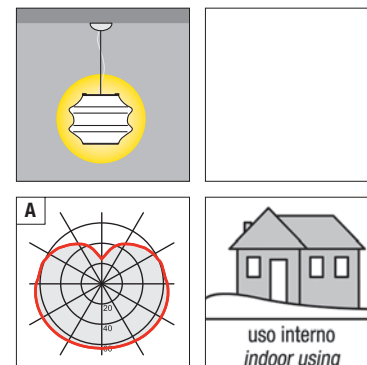



Girotondo

Lampada a sospensione per illuminazione di ambienti con luce diffusa. Diffusore in vetro soffiato opale triplex satinato. Particolari in metallo cromato. Rosone in policarbonato colore bianco opaco.

Suspension lamp to illuminate with diffused light. Diffuser made in blown satin opal triplex glass. Details made in chrome plated metal. Top cover made in matt white polycarbonate.

Lampe à suspension pour éclairage avec lumière diffuse. Diffuseur en verre soufflé opale triplex satiné. Détails réalisée en métal chromé. Patère en polycarbonate blanc satiné.

Lámpara de suspensión para iluminación de ambientes con luz difusa. Difusor de vidrio soplado opal triplex satinado. Detalles de metal cromado. Rosetón en policarbonato color blanco opaco.

Hängeleuchte zur Beleuchtung von Räumen mit diffusem Licht. Diffusor aus geblasenem Triplex-Opalglas satiniert. Details aus verchromtem Metall. Rosette aus mattweißem Polycarbonat.

Girotondo

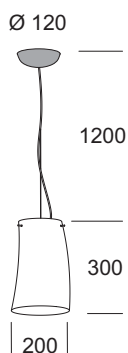

Articolo Item	Colore vetro Glass color		W _{max}		LUMEN		LUMEN/W	
	OP	Codice Code						
E27 girotondo		71841	1x116	E27	2135	IP20	18	A

Kit grappolo

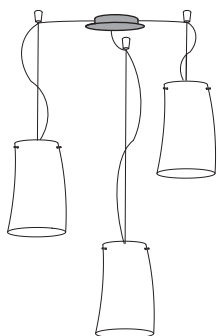

kit grappolo 2	70941	max 2 sospensioni – max 2 fittings.
kit grappolo 3	70951	max 3 sospensioni – max 3 fittings.
kit grappolo 4	70961	max 4 sospensioni – max 4 fittings

Il kit grappolo è composto da:

- 1 rosone in metallo Ø 160mm. colore bianco opaco.
- sistema di fissaggio in metallo cromato per ogni sospensione.

Le sospensioni vanno acquistate in aggiunta al kit e sono cablate con 1,2mt di cavo.

A richiesta è possibile fornire le sospensioni con cavi più lunghi.

Grappolo kit is composed by:

- 1 top cover Ø 160mm. made in matt white painted metal.
- fixing system made in chrome plated metal for each suspension.

Suspensions must be purchased in addition to the kit and they are equipped with 1,2mt wires long.

By request we can provide suspensions with longer cables.

Colore vetro Glass color

OP

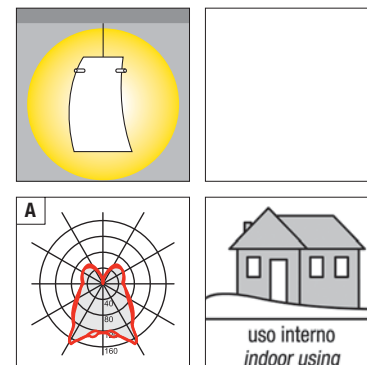
Opale satinato *Satin opal*



Artika

Lampada a sospensione per illuminazione di ambienti con luce diffusa. **Diffusore in vetro soffiato opale triplex satinato.** Montatura in metallo verniciato. Rosone in polycarbonato colore bianco opaco.

Suspension lamp to illuminate with diffused light. **Diffuser made in blown satin opal triplex glass.** Frame made in painted metal. Top cover made in matt white polycarbonate.

Lampe à suspension pour éclairage avec lumière diffuse. **Diffuseur en verre soufflé opale triplex satiné.** Monture réalisée en métal vernie. Patère en polycarbonate blanc satiné.

Lámpara de suspensión para iluminación de ambientes con luz difusa. **Difusor de vidrio soplado opal triplex satinado.** Montadura de metal pintado. Rosetón en polycarbonato color blanco opaco.

Hängeleuchte zur Beleuchtung von Räumen mit diffusem Licht. **Diffusor aus geblasenem Triplex-Opalglas, satiniert.** Fassung aus lackiertem Metall. Rosette aus mattweißem Polycarbonat.

Artika 400

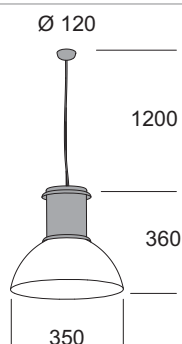

Colore struttura Structure color

Articolo Item

AL	NE	BI
Codice Code		

W_{max}

LUMEN



LUMEN/W



E27	artika 400	71420	71429	71421	1x116	E27	2135	IP20	☐	18	A
EL	artika 400 EL	78110	78119	78111	1x42(a)	GX24q-4	3200	IP20	⊕	76	B

Kit grappolo



kit grappolo 2 70941 max 2 sospensioni – max 2 fittings.

kit grappolo 3 70951 max 3 sospensioni – max 3 fittings.

kit grappolo 4 70961 max 4 sospensioni – max 4 fittings.

Il kit grappolo è composto da:

- 1 rosone in metallo Ø 160mm. colore bianco opaco.
- sistema di fissaggio in metallo cromato per ogni sospensione.

Le sospensioni vanno acquistate in aggiunta al kit e sono cablate con 1,2mt di cavo.

A richiesta è possibile fornire le sospensioni con cavi più lunghi.

Grappolo kit is composed by:

- 1 top cover Ø 160mm. made in matt white painted metal.
- fixing system made in chrome plated metal for each suspension.

Suspensions must be purchased in addition to the kit and they are equipped with 1,2mt wires long.

By request we can provide suspensions with longer cables.

Colore struttura Structure color

AL	RAL 9006 Alluminio opaco Aluminium matt	NE	RAL 9005 Nero opaco Matt black	BI	RAL 9016 Bianco opaco Matt white
----	---	----	--	----	--

- (a) Equipaggiato con alimentatore multipotenza per l'utilizzo di lampade da 26W-32W o 42W.
Equipped with multi-power ballast to use bulbs of 26W-32W or 42W.

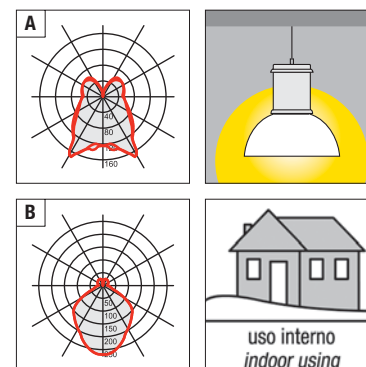



Work

Lampada a sospensione per illuminazione di ambienti con luce diretta. Diffusore in metallo verniciato. Le versioni colore nero e alluminio hanno la superficie interna verniciata bianco ral 9016. Rosone in policarbonato colore bianco opaco. **Versione LED fornita con schermo in policarbonato opale, led smd e alimentatore elettronico incorporato.**

Suspension lamp to illuminate with direct light. Diffuser made in painted metal. Versions black and aluminium coloured have inside surface painted white ral 9016. Top cover made in matt white polycarbonate. **LED version supplied with opal polycarbonate screen, smd led and electronic driver included.**

Lampe à suspension pour éclairage avec lumière directe. Diffuseur réalisé en métal verni. Les versions couleur noir et aluminium ont la surface intérieure couleur blanc ral 9016. Patère en polycarbonate blanc satiné. **Version LED équipée avec écran en polycarbonate opale, led smd et ballast électronique incorporé.**

Lámpara de suspensión para iluminación de ambientes con luz directa. Difusor en metal pintado. Las versiones en color negro y aluminio tienen la superficie interna pintada blanco ral 9016. Rosetón en policarbonato color blanco opaco. **Version LED suministrada con pantalla en policarbonato opale, led smd y alimentador electrónico incluido.**

Hängeleuchte zur Beleuchtung von Räumen mit direktem Licht. Diffusor aus lackiertem Metall. Die Innenfläche bei den Ausführungen in schwarz und aluminiumfarben ist weiß lackiert Ral 9016. Rosette aus mattweißem Polycarbonat. **Ausführung LED mit Bildschirm aus Opal Polycarbonat, led smd und integriert Versorgungsgerät elektronisch.**

Work 370

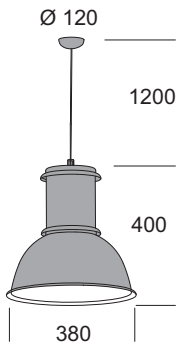

Colore struttura Structure color

Articolo Item	Colore struttura Structure color			W _{max}	Icona	LUMEN	Icona	LUMEN/W	Icona	
	AL	NE	BI							
Codice Code										
E27 work 370	71510	71519	71511	1x116	E27	2135	IP20	□	18	A
● Led work 370 led-W	75940	75949	75941	34,1	led	3550	IP20	⊕	104	C
● Led DM work 370 DM led-W	75950	75959	75951	34,1	led	3550	IP20	⊕	104	C
● Led work 370 led-N	75960	75969	75961	34,1	led	3550	IP20	⊕	104	C
● Led DM work 370 DM led-N	75970	75979	75971	34,1	led	3550	IP20	⊕	104	C
EL work 370 EL	78810	78819	78811	1x42(a)	GX24q-4	3200	IP20	⊕	76	B

Kit grappolo



kit grappolo 2	70941	max 2 sospensioni – max 2 fittings.
kit grappolo 3	70951	max 3 sospensioni – max 3 fittings.
kit grappolo 4	70961	max 4 sospensioni – max 4 fittings.

Il kit grappolo è composto da:

- 1 rosone in metallo Ø 160mm. colore bianco opaco.
 - sistema di fissaggio in metallo cromato per ogni sospensione.
- Le sospensioni vanno acquistate in aggiunta al kit e sono cablate con 1,2mt di cavo. A richiesta è possibile fornire le sospensioni con cavi più lunghi.

Grappolo kit is composed by:

- 1 top cover Ø 160mm. made in matt white painted metal.
 - fixing system made in chrome plated metal for each suspension.
- Suspensions must be purchased in addition to the kit and they are equipped with 1,2mt wires long. By request we can provide suspensions with longer cables.

Colore struttura Structure color

● Nuova versione New version

AL RAL 9006 Alluminio opaco Aluminium matt	NE RAL 9005 Nero opaco Matt black	BI RAL 9016 Bianco opaco Matt white
---	--------------------------------------	--

- Led Equipaggiata con led 3000K - Equipped with led 3000K
- Led Equipaggiata con led 4000K - Equipped with led 4000K
- Led DM Led DM Dimmerabile PUSH/DALI
Dimmable PUSH/DALI (info page10)

(a) Equipaggiato con alimentatore multipotenza per l'utilizzo di lampade da 26W-32W o 42W
Equipped with multi-power ballast to use bulbs of 26W-32W or 42W

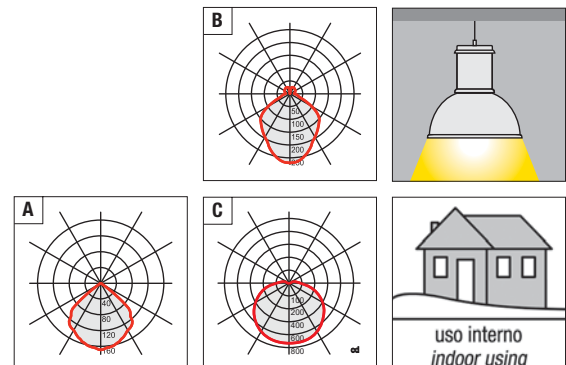

Railroad

Lampada a sospensione per illuminazione di ambienti con luce diretta. Diffusore in metallo verniciato. Le versioni colore nero e alluminio hanno la superficie interna verniciata bianco ral 9016. Rosone in policarbonato colore bianco opaco. **Versione LED fornita con schermo in policarbonato opale, led smd e alimentatore elettronico incorporato.**

Suspension lamp to illuminate with direct light. Diffuser made in painted metal. Versions black and aluminium coloured have inside surface painted white ral 9016. Top cover made in matt white polycarbonate. **LED version supplied with opal polycarbonate screen, smd led and electronic driver included.**

Lampe à suspension pour éclairage avec lumière directe. Diffuseur réalisé en métal verni. Les versions couleur noir et aluminium ont la surface intérieure couleur blanc ral 9016. Patère en polycarbonate blanc satiné. **Version LED équipée avec écran en polycarbonate opale, led smd et ballast électronique incorporé.**

Lámpara de suspensión para iluminación de ambientes con luz directa. Difusor en metal pintado. Las versiones en color negro y aluminio tienen la superficie interna pintada blanco ral 9016. Rosetón en policarbonato color blanco opaco. **Version LED suministrada con pantalla en policarbonato opale, led smd y alimentador electrónico incluido.**

Hängeleuchte zur Beleuchtung von Räumen mit direktem Licht. Diffusor aus lackiertem Metall. Die Innenfläche bei den Ausführungen in schwarz und aluminiumfarben ist weiß lackiert Ral 9016. Rosette aus mattweißem Polycarbonat. **Ausführung LED mit Bildschirm aus Opal Polykarbonat, led smd und integriert Versorgungsgerät elektronisch.**



Colore struttura Structure color

Railroad 400

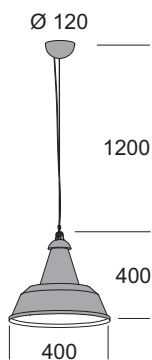

Articolo Item	Colore struttura Structure color			W _{max}	E27	LUMEN	IP	LUMEN/W	A
	AL	NE	BI						
E27 railroad 400	71500	71509	71501	1x116	E27	2135	IP20	18	A
● Led railroad 400 led-W	76000	76009	76001	34,1	led	3550	IP20	104	B
● Led DM railroad 400 DM led-W	76010	76019	76011	34,1	led	3550	IP20	104	B
● Led railroad 400 led-N	76020	76029	76021	34,1	led	3550	IP20	104	B
● Led DM railroad 400 DM led-N	76030	76039	76031	34,1	led	3550	IP20	104	B

Kit grappolo



kit grappolo 2	70941	max 2 sospensioni – max 2 fittings.
kit grappolo 3	70951	max 3 sospensioni – max 3 fittings.
kit grappolo 4	70961	max 4 sospensioni – max 4 fittings.

Il kit grappolo è composto da:

- 1 rosone in metallo Ø 160mm. colore bianco opaco.
- sistema di fissaggio in metallo cromato per ogni sospensione.

Le sospensioni vanno acquistate in aggiunta al kit e sono cablate con 1,2mt di cavo.

A richiesta è possibile fornire le sospensioni con cavi più lunghi.

Grappolo kit is composed by:

- 1 top cover Ø 160mm. made in matt white painted metal.
- fixing system made in chrome plated metal for each suspension.

Suspensions must be purchased in addition to the kit and they are equipped with 1,2mt wires long.

By request we can provide suspensions with longer cables.

Colore struttura Structure color

● Nuova versione New version

AL RAL 9006 Alluminio opaco Aluminium matt	NE RAL 9005 Nero opaco Matt black	BI RAL 9016 Bianco opaco Matt white
---	--------------------------------------	--

● Led Equipaggiata con led 3000K - Equipped with led 3000K

● Led Equipaggiata con led 4000K - Equipped with led 4000K

● Led DM ● Led DM Dimmerabile PUSH/DALI
Dimmable PUSH/DALI (info page10)

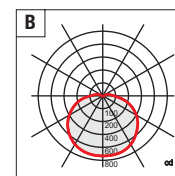
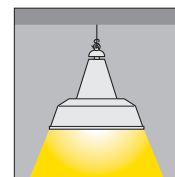
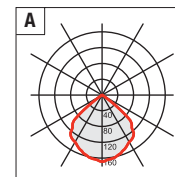



14 applique interni/esterni
wall lights indoor/outdoor

150 plafoniere interni/esterni
ceiling bowls indoor/outdoor

248 testaleto
bed head units



258 sospensioni
suspensions

344 lampade
lamps

384 lampioni ed incassi
bollards & recessed lights

450 indice
index

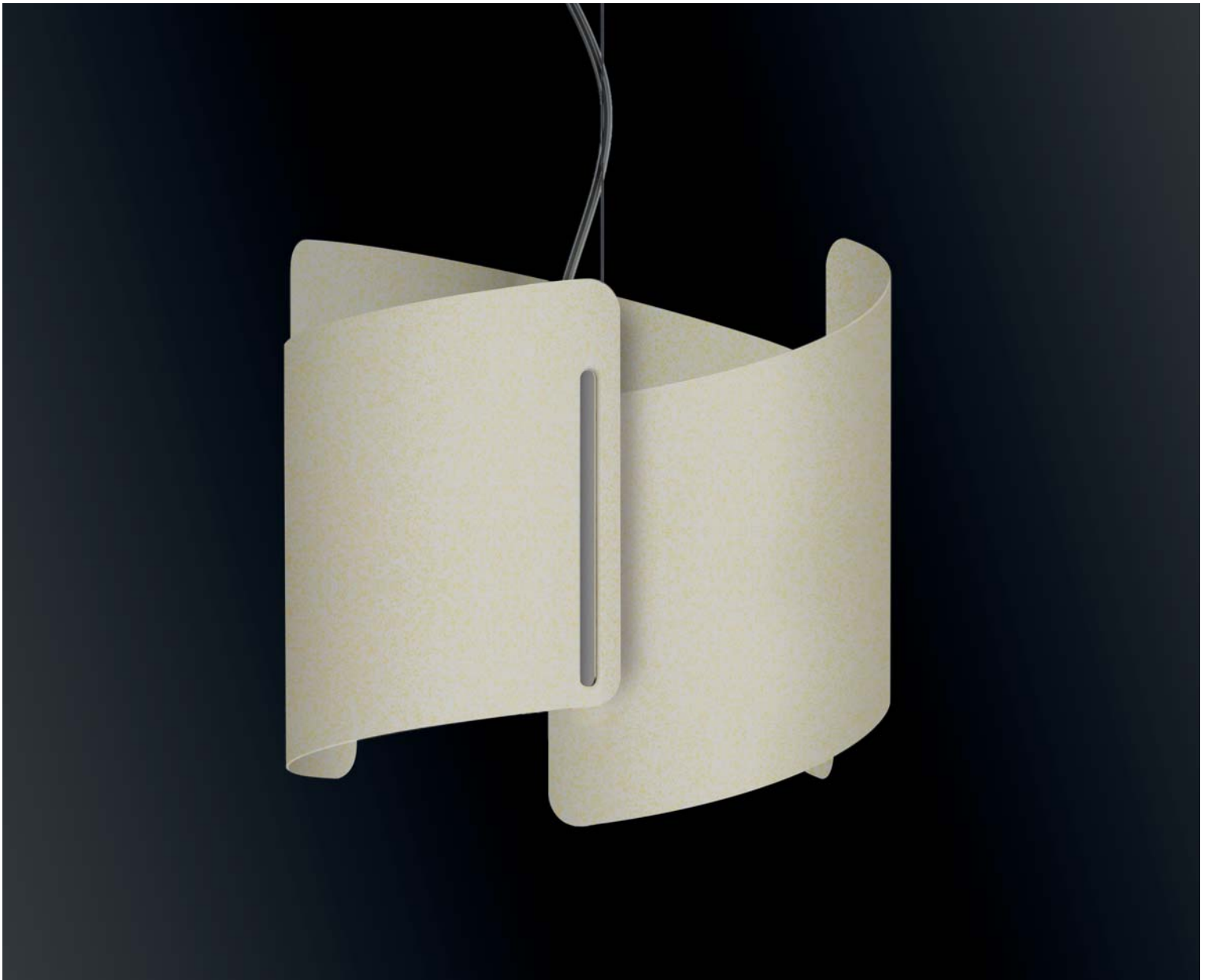

Trilyum

Lampada a sospensione per illuminazione di ambienti con luce diffusa. Diffusore in polipropilene con serigrafia colore avorio. Struttura in metallo verniciato bianco ral 9016. Decorì in metallo verniciato alluminio ral 9006. Rosone in policarbonato colore bianco opaco.

Suspension lamp to illuminate with diffused light. Diffuser made in polypropylene with serigraphy ivory colour. Structure made in white painted metal ral 9016. Details made in metal painted aluminium ral 9006. Top cover made in matt white polycarbonate.

Lampe à suspension pour éclairage avec lumière diffuse. Diffuseur en polypropylène avec sérigraphie couleur ivoire. Structure réalisée en métal vernie blanc ral 9016. Détails en métal verni couleur aluminium ral 9006. Patère en polycarbonate blanc satiné.

Lámpara de suspensión para iluminación de ambientes con luz difusa. Difusor de polipropileno con serigrafía color marfil. Estructura en metal pintado blanco ral 9016. Detalles de metal pintado aluminio ral 9006. Rosetón en policarbonato color blanco opaco.

Hängeleuchte zur Beleuchtung von Räumen mit diffusem Licht. Diffusor aus Polypropylen mit Siebdruck, elfenbeinfarben. Struktur aus weiß lackiertem Metall Ral 9016. Details aus Aluminium lackiertem Metall Ral 9006. Rosette aus mattweißem Polycarbonat.

Trilyum

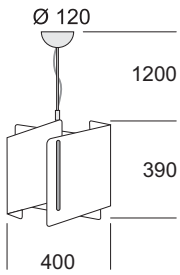

Articolo Item	Codice Code	W _{max}		LUMEN		LUMEN/W	
E27 trilyum	72110	1x116	E27	2135	IP20	18	A

14 applique interni/esterni
wall lights indoor/outdoor

150 plafoniere interni/esterni
ceiling bowls indoor/outdoor

248 testata letto
bed head units

258 sospensioni
suspensions

344 lampade
lamps

384 lampioni ed incassi
bollards & recessed lights

450 indice
index

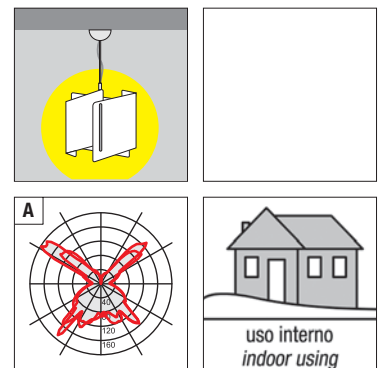



Zeus

Lampada a sospensione per illuminazione di ambienti con luce diretta. Diffusore in vetro soffiato trasparente satinato. Montatura e rosone in metallo verniciato o con finitura galvanica. **Versione LED equipaggiata con led smd.**

Suspension lamp to illuminate with direct light. Diffuser made in blown satin transparent glass. Frame and top cover made in painted metal or with galvanic finish. **LED version equipped with smd LED.**

Lampe à suspension pour éclairage avec lumière directe. Diffuseur en verre soufflé transparent satiné. Monture e patère réalisés en métal vernie ou avec finition galvanique. **Version LED équipée avec led smd.**

Lámpara de suspensión para iluminación de ambientes con luz directa. Difusor de vidrio soplado transparente satinado. Montadura y rosetón en metal pintado o con acabado galvánico. **Versiones LED suministradas con led smd.**

Hängeleuchte zur Beleuchtung von Räumen mit direktem Licht. Diffusor aus geblasenem Transparentglas, satiniert. Fassung und Rosette aus lackiertem Metall oder mit galvanischem Finish. **Version LED ausgestattet mit led smd.**

Zeus

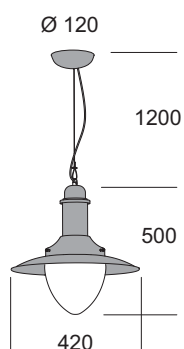

Colore struttura Structure color

Articolo Item	Colore struttura Structure color				W _{max}		LUMEN		LUMEN/W		
	AT	GR	BR	RA							Codice Code
E27 zeus	71537	71530	71539	71538	1x77	E27	1320	IP20	⊕	17	A
zeus led-W	75987	75980	75989	75988	17	led	1590	IP20	⊕	94	B
zeus led-N	75997	75990	75999	75998	17	led	1590	IP20	⊕	94	B

Colore struttura Structure color

● Nuova versione New version

AT RAL 7016
Antracite gofrato Embossed anthracite

GR RAL 9006
Grigio gofrato Embossed grey

BR
Brunito Burnished

RA
Ramato Coppered

Equipaggiata con led 3000K - Equipped with led 3000K

Equipaggiata con led 4000K - Equipped with led 4000K

Compatibile con dimmer a taglio di fase (TRIAC)
Compatible with phase cut dimmer (TRIAC)

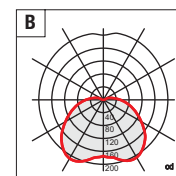
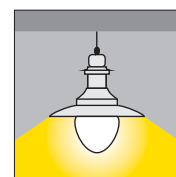
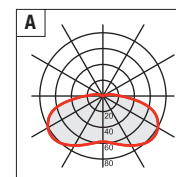

Lampade - Lamps



Cosmo 348



Cosmo T 350



Girotondo G 364



Girotondo T 364



Nordica T2 366



Ti light T 368



Vitrum 370



Chrome G 372



Duo T 380



Tris 382



NEW 



Kyo 352

NEW 



Asia 354





Cut-off 356



Avalon 358



Alice 360



July 362



Dado plissé G 374



Dado G 374



Retrò G 376



Retrò T 376



Trilyum 378





Trilyum T 378



NEW Nuovo prodotto *New product*

 Versione LED *LED version*

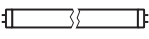
 Versione RGB *RGB version*

G5 T5				FDH	LED 	RGB 	EMERGENZA EMERGENCY	PAG./PAGE	ARTICOLO/ITEM
1 X	3 X	4 X							
								360	ALICE
					8,33/15,3			354	ASIA/P - ASIA/G
								358	AVALON
								372	CHROME
					14,9			348	COSMO/G
					14,9			350	COSMO/T
					5			356	CUT-OFF
								374	DADO PLISSÉ/G
								374	DADO/G
		39			68,8		○	380	DUO/T
								364	GIROTONDO/G
								364	GIROTONDO/T
								362	JULY
					9,3			352	KYO
								366	NORDICA/T2
								376	RETRÒ/G
								376	RETRÒ/T
								368	TI-LIGHT/T
								378	TRILYUM/G TRILYUM/P
								378	TRILYUM/T
	80							382	TRIS
80					31,2			370	VITRUM



Cosmo

Lampade da tavolo. Diffusore in vetro soffiato opale triplex satinato. Anello trasparente o colorato, in policarbonato autoestinguente. Struttura interna in metallo verniciato bianco ral 9016. La lampada Cosmo/G200 ha la montatura in metallo verniciato bianco ral 9016 opaco. **Versione LED equipaggiata con led smd e alimentatore elettronico incorporato.**

Table lamps. Diffuser made in blown satin opal triplex glass. Transparent or coloured ring made in auto-extinguishing polycarbonate. Inside structure made in metal white painted ral 9016. Model Cosmo/G200 has frame made in metal matt white painted ral 9016. **LED version equipped with smd led and electronic driver included.**

Lampes de table. Diffuseur en verre soufflé opale triplex satiné. Anneau transparent ou coloré, réalisé en polycarbonate auto-extinguible. Structure interne réalisée en métal vernie blanc ral 9016. Le model Cosmo/G200 a la monture réalisée en métal vernie blanc opaque ral 9016. **Version LED équipée avec led smd et ballast électronique incorporé.**



Lámparas de mesa. Difusor de vidrio soplado opal triplex satinado. Anillo transparente o de colores, en policarbonato de autoextinción. Estructura interna en metal pintado blanco ral 9016. La lámpara Cosmo/G200 tiene la montadura en metal pintado blanco opaco ral 9016. **Version LED suministrada con led smd y alimentador electrónico incluido.**

Tischlampen. Diffusor aus geblasenem Triplex-Opalglas, satiniert. Ring transparente oder farbige, aus selbstlöschendem Polycarbonat. Interne Struktur aus weiß lackiertem Metall Ral 9016. Der Lampe Cosmo/P hat Fassung aus matt weiß lackiertem Metall Ral 9016. **Ausführung LED zum led smd und integriert Versorgungsgerät elektronisch.**

Cosmo/G200

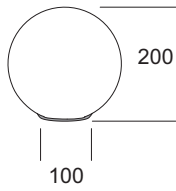

Articolo Item	Colore anello Ring color				W _{max}	Beam	LUMEN	IP	LUMEN/W	Icon
	BI	Codice Code								
E14 cosmo/G200	88090	1x46	E14	700	IP20	□	15	A		

Cosmo/G300

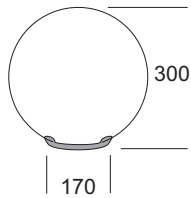

Articolo Item	Colore montatura Frame color				W _{max}	Beam	LUMEN	IP	LUMEN/W	Icon	
	BL	GI	RO	TR							Codice Code
E27 cosmo/G300	85135	85132	85133	85130	1x77	E27	1320	IP20	□	17	A
Led cosmo/G300 led-W	85375	85372	85373	85370	14,9	led	2000	IP20	⊕	134	B
Led cosmo/G300 led-N	85385	85382	85383	85380	14,9	led	2000	IP20	⊕	134	B

Cosmo/G400

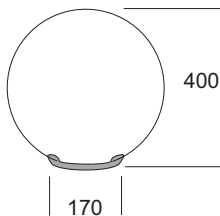

E27 cosmo/G400	85335	85332	85333	85330	1x116	E27	2135	IP20	□	18	A
Led cosmo/G400 led-W	85395	85392	85393	85390	14,9	led	2000	IP20	⊕	134	B
Led cosmo/G400 led-N	85405	85402	85403	85400	14,9	led	2000	IP20	⊕	134	B

Colore anello Ring color

● Nuova versione New version

BI RAL 9016 Bianco opaco Matt white	BL RAL 5017 Blu Blue	GI RAL 1023 Giallo Yellow	RO RAL 3000 Rosso Red	TR Trasparente Transparent
--	-------------------------	------------------------------	--------------------------	-------------------------------

Led Equipaggiata con led 3000K - Equipped with led 3000K

Led Equipaggiata con led 4000K - Equipped with led 4000K

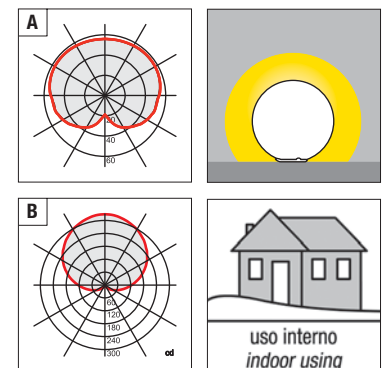

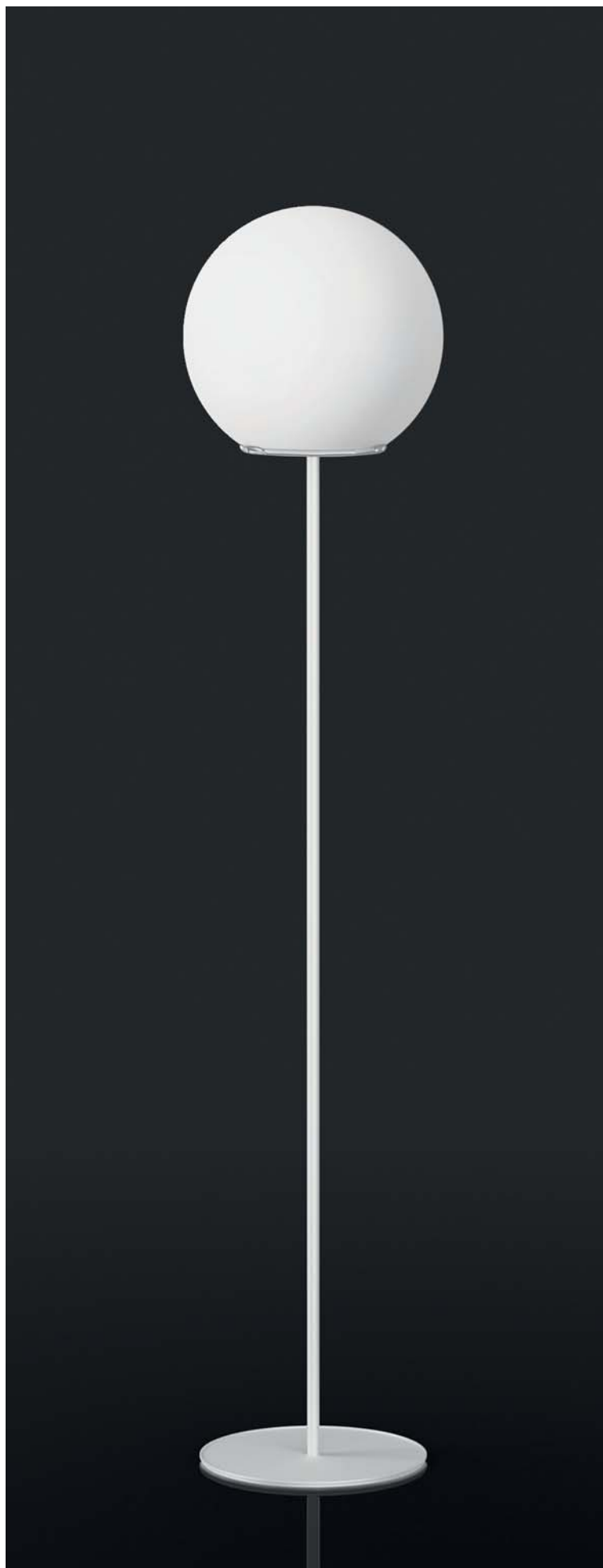

Cosmo T

Lampada da terra. Diffusore in vetro soffiato opale triplex satinato. Anello trasparente o colorato, in policarbonato autoestinguente. Struttura in metallo verniciato bianco opaco ral 9016. Versione E27 fornita con regolatore di intensità luminosa. **Versione LED equipaggiata con led smd e alimentatore elettronico incorporato.**

Floor lamp. Diffuser made in blown satin opal triplex glass. Transparent or coloured ring made in auto-extinguishing polycarbonate. Structure made in metal matt white painted ral 9016. E27 version equipped with dimmer. **LED version equipped with smd led and electronic driver included.**

Lampadaire. Diffuseur en verre soufflé opale triplex satiné. Anneau transparent ou coloré, réalisé en polycarbonate auto-extinguible. Structure réalisée en métal vernie blanc opaque ral 9016. Version E27 équipée avec variateur. **Version LED équipée avec led smd et ballast électronique incorporé.**

Lámpara de pie. Difusor de vidrio soplado opal triplex satinado. Anillo transparente o de colores, en policarbonato de autoextinción. Estructura en metal pintado blanco opaco ral 9016. Version E27 suministrada con regulador de intensidad luminosa. **Version LED suministrada con led smd y alimentador electrónico incluido.**

Stehlampe. Diffusor aus geblasenem Triplex-Opalglas, satiniert. Ring transparente oder farbige, aus selbstlöschendem Polycarbonat. Struktur aus matt weiß lackiertem Metall Ral 9016. Ausführung E27 mit Leuchtstärkenregler. **Ausführung LED zum led smd und integriert Versorgungsgerät elektronisch.**



Cosmo /T

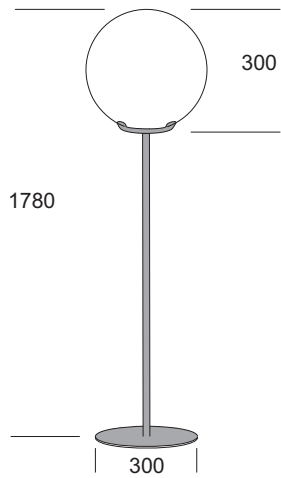

Articolo <i>Item</i>	Colore anello <i>Ring color</i>				W _{max}		LUMEN		LUMEN/W		
	BL	GI	RO	TR							Codice <i>Code</i>
E27 cosmo/T	81185	81182	81183	81180	1x116	E27	2135	IP20		18	A
cosmo/T led-W	81595	81592	81593	81590	14,9	led	2000	IP20		134	B
cosmo/T led-N	81605	81602	81603	81600	14,9	led	2000	IP20		134	B

Colore anello *Ring color*

BL RAL 5017 Blu <i>Blue</i>	GI RAL 1023 Giallo <i>Yellow</i>	RO RAL 3000 Rosso <i>Red</i>	TR Trasparente <i>Transparent</i>
---------------------------------------	--	--	---

● Nuova versione *New version*

- Equipaggiata con led 3000K - *Equipped with led 3000K*
- Equipaggiata con led 4000K - *Equipped with led 4000K*

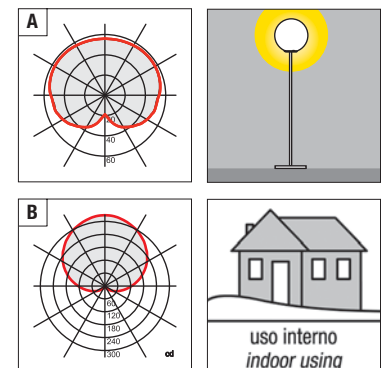

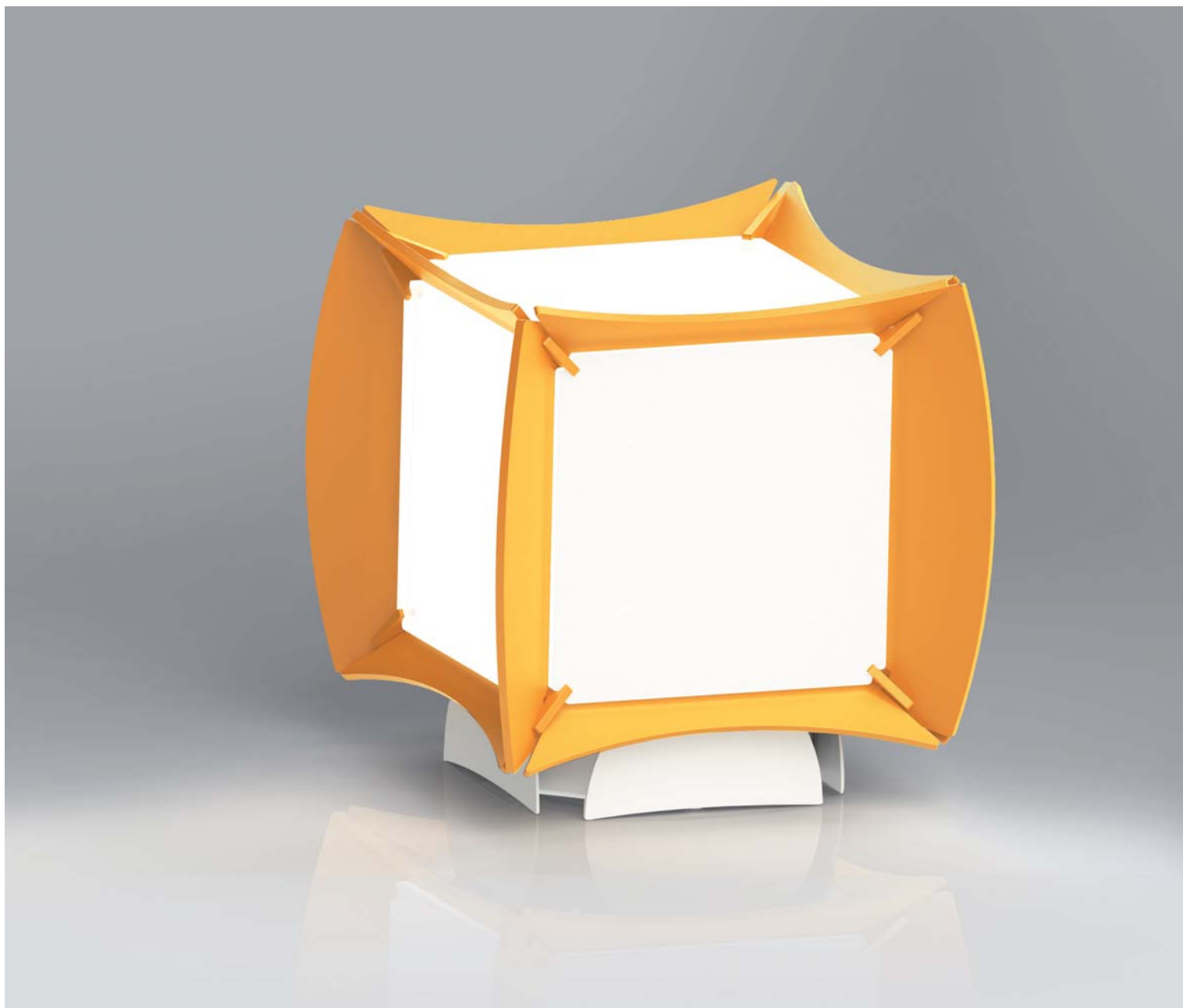

Kyo

Lampada da tavolo. Diffusore in policarbonato opale. Struttura in metallo verniciato. La struttura è realizzata combinando elementi planari senza utilizzo di viti o collanti. **Versione led equipaggiata con LED COB e alimentatore elettronico incorporato.**

Table lamp. Diffuser made in opal polycarbonate. Structure made in painted metal. The structure is obtained combining simple planar elements without any screws or glue. **Led version equipped with COB LED and electronic gear included.**

Lampe de table. Diffuseur réalisé en polycarbonate opale. Structure réalisée en métal verni. La structure est réalisée combinant des éléments plats sans utiliser des vis ou collant. **Version led équipée avec LED COB et ballast électronique incorporé.**

Lámpara de mesa. Difusor de policarbonato opal. Estructura en metal pintado. La estructura está realizada combinando elementos planos sin el uso de tornillos o colas. **Versione led suministrada con LED COB y alimentador electrónico incorporado.**

Tischlampe. Diffusor aus opalfarbenem Polycarbonat. Struktur aus lackiertem Metall. Die Struktur besteht aus einer Kombination ebener Elemente, ohne Schrauben oder Klebstoffe. **Ausführung LED zum LED COB und eingebautem elektronischem Versorgungsgerät.**

Kyo

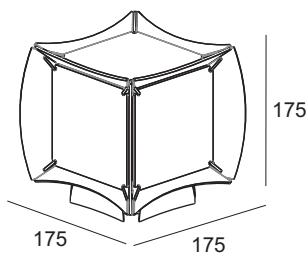

Colore struttura Structure color

Articolo Item	Colore struttura Structure color				W _{max}		LUMEN		LUMEN/W		
	AL	AR	BI	GI							Codice Code
E14 kyo					1x46	E14	700	IP20		15	A
Led kyo led-W					9,3	led	975	IP20		105	A
Led kyo led-N					9,3	led	975	IP20		105	A

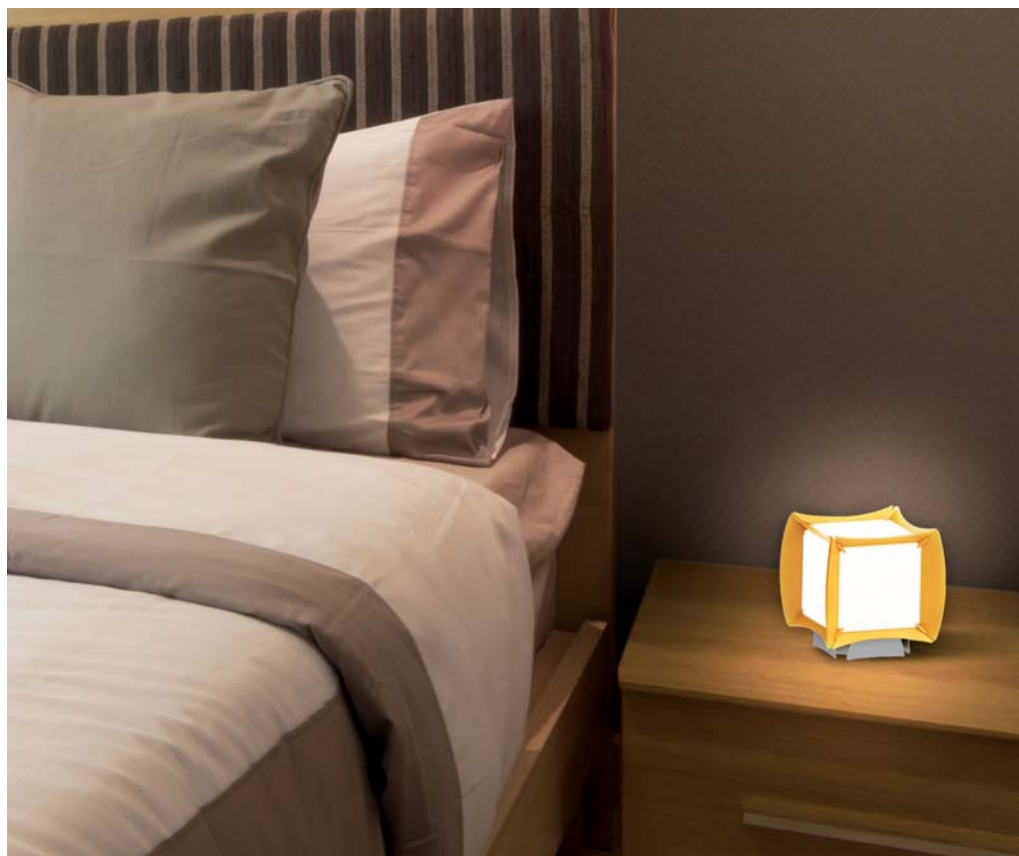

Colore struttura Structure color

AR RAL 2001 Arancio Rosso Opaco <i>Matt Red Orange</i>	BI RAL 9016 Bianco opaco <i>Matt white</i>	GI RAL 1028 Giallo Melone Opaco <i>Matt Melon Yellow</i>	AL RAL 9006 Alluminio <i>Aluminium</i>
---	---	---	---

- Led** Equipaggiata con led 3000K - *Equipped with led 3000K*
- Led** Equipaggiata con led 4000K - *Equipped with led 4000K*

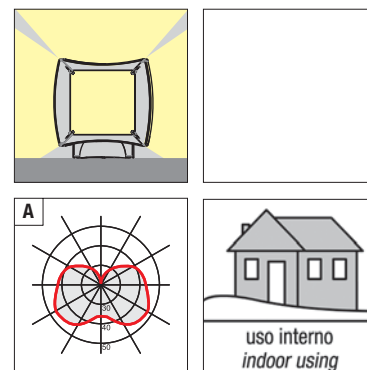



Asia

Lampade da tavolo. Struttura e diffusore in metallo verniciato con schermo in policarbonato opale. La versione bianca ha il cavo elettrico rosso, la versione nera ha la superficie interna del diffusore bianca ed il cavo elettrico bianco. **Equipaggiata con led smd e alimentatore elettronico incorporato.** La finitura ed il cavo possono cambiare a richiesta del cliente.

Table lamps. Structure and diffuser made in painted metal with opal polycarbonate screen. Version white colour is equipped with red electric cable, version black colour has diffuser inside surface painted white and white electric cable. **Equipped with smd led and electronic driver included.** Finish and cable can change based on client request.

Lampes de table. Structure et diffuseur réalisé en métal verni avec écran en polycarbonate opale. La version blanc est équipée avec câble électrique rouge, la version noire a la surface intérieure du diffuseur blanc et le câble électrique blanc. **Equipée avec led smd et ballast électronique incorporé.** La finition et le câble peuvent changé selon la demande du client.

Lámparas de mesa. Structura y difusor en metal pintado, pantalla en policarbonato opale. La version blanca tiene el cable rojo, la version negra tiene la superficie interna del difusor blanca y el cable blanco. **Suministrada con led smd y alimentador electronico incluido.** Acabado y cable puede cambiar a petición del cliente.

Tischlampen. Struktur und Diffusor aus lackiertem Metall mit Bildschirm aus Opal Polykarbonat. Die weiße Version hat die rote Stromkabel, die schwarze Version hat die innere Diffusor Oberfläche der weißen und der schwarzen Netzkabel. **Ausgestattet mit SMD-LEDs und elektronische Stromversorgung.** Die Farbe und Kabel könne auf die Bedürfnisse des Kunden abgestimmt werden.

Asia/P



Articolo <i>Item</i>	Colore struttura <i>Structure color</i>		W _{max}		LUMEN		LUMEN/W	
	BI Codice	NE Code						
Led asia/P led-W	88171	88177	8,33	led	1090	IP20		131 A
Led asia/P led-N	88181	88187	8,33	led	1090	IP20		131 A

Asia/G



Led asia/G led-W	85421	85427	15,3	led	2070	IP20		135 A
Led asia/G led-N	85431	85437	15,3	led	2070	IP20		135 A

Colore struttura *Structure color*

BI RAL 9016
Bianco opaco *Matt white*

NE RAL 9005
Nero opaco *Matt black*

- Led** Equipaggiata con led 3000K - *Equipped with led 3000K*
- Led** Equipaggiata con led 4000K - *Equipped with led 4000K*

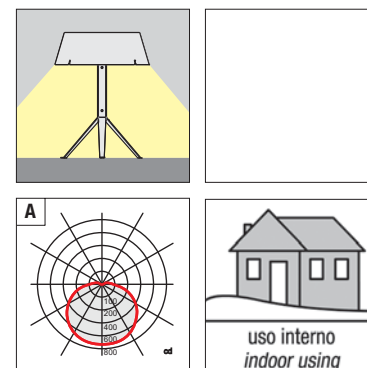

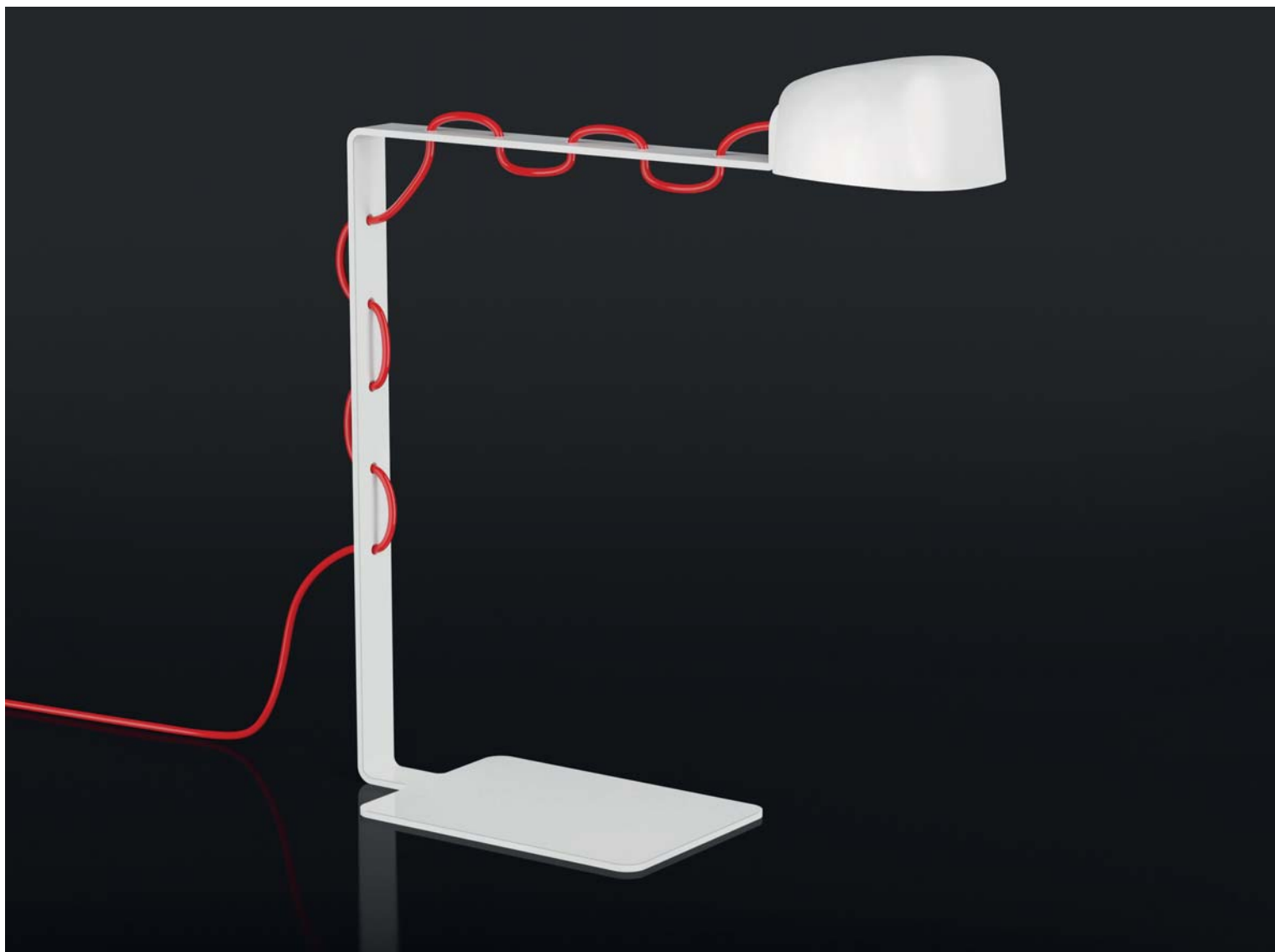

Cut-off

Lampada da tavolo con diffusore orientabile in vetro soffiato opale triplex satinato. Struttura in metallo verniciato. La versione bianca ha il cavo elettrico rosso, la versione nera ha il cavo elettrico bianco. **Nuova versione equipaggiata con lampadina led.**

Table lamp with adjustable diffuser made in blown satin opal triplex glass. Structure made in painted metal. Version white colour is equipped with red electric cable, version black colour has white electric cable. **New version equipped with led bulb.**

Lampe de table avec diffuseur réglable réalisé en verre soufflé opale triplex satiné. Structure réalisée en métal vernie. La version blanc est équipée avec câble électrique rouge, la version noire a le câble électrique blanc. **Nouvelle version équipée avec ampoule LED.**

Lámpara de mesa con difusor giratorio de vidrio soplado opal triplex satinado. Estructura en metal pintado. La versione blanca tiene el cable rojo, la versione negra tiene el cable blanco. **Nueva versione suministrada con lampadina LED.**

Tischlampe mit einstellbarem Diffusor aus geblasenem Triplex-Opalglas, satiniert. Struktur aus lackiertem Metall. Die weiße Version hat die rote Stromkabel, die schwarze Version hat die schwarzen Netzkabel. **Neue Version ausgestattet mit einer LED Lampe.**

Cut-off

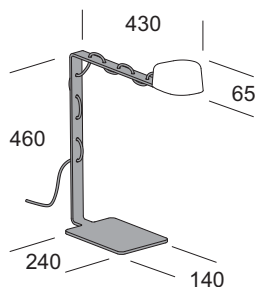

Colore struttura Structure color

BI **NE**

Codice Code

Articolo Item	BI	NE	W _{max}		LUMEN		LUMEN/W	
● Led cut-off led-W	85411	85417	5	G9	400	IP20	80	
HL cut-off	85211	85217	1x60	G9	980	IP20	16	



Colore struttura Structure color

BI RAL 9016
Bianco opaco *Matt white*

NE RAL 9005
Nero opaco *Matt black*

● Nuova versione *New version*

Led Equipaggiata con led 3000K - *Equipped with led 3000K*

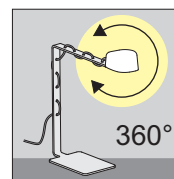



Avalon

Lampada da tavolo. Diffusore in vetro soffiato opale triplex lucido. Struttura in metallo cromato. Base in cuoio colore testa di moro.

Table lamp. Diffuser made in blown shiny opal triplex glass. Structure in chrome plated metal. Base made in dark brown leather.

Lampe de table. Diffuseur en verre soufflé opale triplex brillant. Structure réalisée en métal chromé. Base en cuir marron foncé.

Lámpara de mesa. Difusor de vidrio soplado opal triplex brillante. Estructura en metal cromado. Base en cuero maron oscuro.

Tischlampe. Diffusor aus geblasenem Triplex-Opalglas, glänzend. Struktur aus verchromtem Metall. Basis aus Leder Farbe schokobraun.

Colore struttura *Structure color*

Articolo *Item*

CR

W_{max}



LUMEN



LUMEN/W



Avalon

Codice *Code*

E27	avalon	85208	1x77	E27	1320	IP20	□	17	A
-----	--------	-------	------	-----	------	------	---	----	---

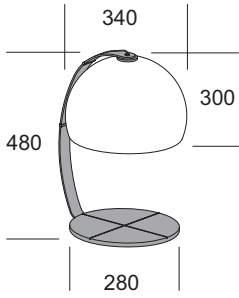

Colore struttura *Structure color*

CR

Cromato *Chrome*

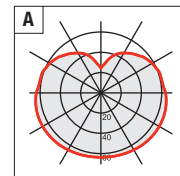
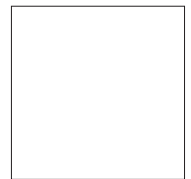
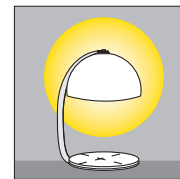

14 applique interni/esterni
wall lights indoor/outdoor

150 plafoniere interni/esterni
ceiling bowls indoor/outdoor

248 testateletto
bed head units

258 sospensioni
suspensions

344 lampade
lamps

384 lampioni ed incassi
bollards & recessed lights

450 indice
index

Alice

Lampade da tavolo con paralume e base in vetro soffiato opale triplex satinato. Struttura in metallo verniciato bianco opaco ral 9016. La lampada Alice/G ha anche la base che si illumina ed è fornita di interruttore per accensioni separate.

Table lamps with shade and base made in blown satin opal triplex glass. Structure made in metal painted matt white ral 9016. Alice/G has the base lighted too and it is equipped with switch for separate lightings.

Lampes de table avec abat-jour et base réalisés en verre soufflé opale triplex satiné. Structure réalisée en métal vernie couleur blanc opaque ral 9016. Alice/G a même la base allumé et est équipée d'interrupteur pour allumages séparaes.

Lámparas de mesa con pantalla y base en vidrio soplado opal triplex satinado. Estructura de metal pintado blanco opaco ral 9016. En la lámpara Alice/G también se ilumina la base, suministrada con interruptor para encendidos separados.

Tischlampen mit Lampenschirm und Basis aus geblasenem Triplex-Opalglas, satiniert. Struktur aus matt weiß lackiertem Metall Ral 9016. Bei der Tischlampe Alice/G wird auch die Basis beleuchtet; mit Schalter zum getrennten Einschalten.



Colore vetro Glass color

OP

W_{max}



LUMEN



LUMEN/W



Alice/P

Codice Code

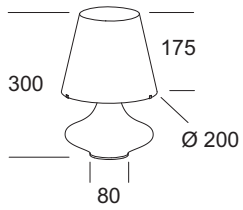

E14	alice/P	88081	1x46	E14	700	IP20	□	15	A
-----	---------	-------	------	-----	-----	------	---	----	---

Alice/G

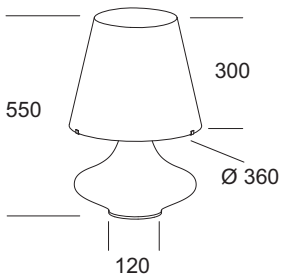

E27	alice/G	85121	1x116	E27	2135	IP20	□	18	A
+			+	+	+				
E14			1x46	E14	700			15	

Colore vetro Glass color

OP

Opale satinato *Satin opal*

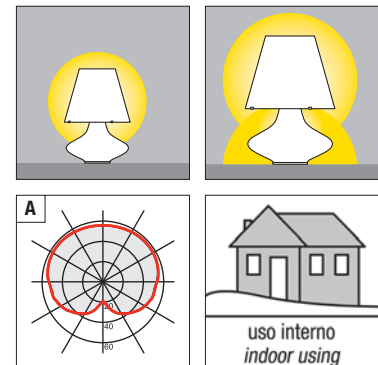



July

Lampade da tavolo. Diffusore in vetro soffiato opale triplex satinato. Struttura in metallo verniciato alluminio ral 9006. Cavo di alimentazione ricoperto in cotone.

Table lamps. Diffuser made in blown satin opal triplex glass. Structure in metal painted aluminium ral 9006. Feeding wire cotton covered.

Lampes de table. Diffuseur en verre soufflé opale triplex satiné. Structure réalisée en métal vernie couleur aluminium ral 9006. Fil d'alimentation revêtis en coton.

Lámparas de mesa. Difusor de vidrio soplado opal triplex satinado. Estructura en metal pintado aluminio ral 9006. Cable de alimentación recubierto de algodón.

Tischlampen. Diffusor aus geblasenem Triplex-Opalglas, satiniert. Struktur aus Aluminium lackiertem Metall Ral 9006. Mit Baumwolle verkleidetes Versorgungskabel.

Colore vetro Glass color

OP

W_{max}



LUMEN

LUMEN/W



July/P

Codice Code

E14	July/P	88151	1x30	E14	405	IP20	□	13	A
-----	--------	-------	------	-----	-----	------	---	----	---

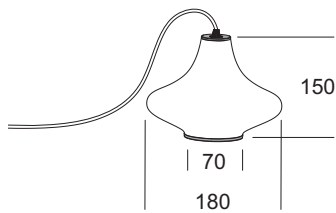

July/G

E27	July/G	85231	1x77	E27	1320	IP20	□	17	A
-----	--------	-------	------	-----	------	------	---	----	---

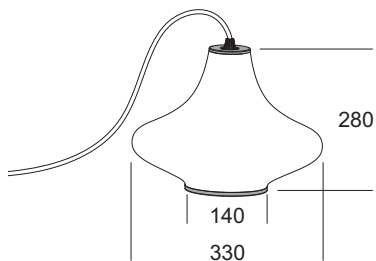

Colore vetro Glass color

OP

Opale satinato *Satin opal*

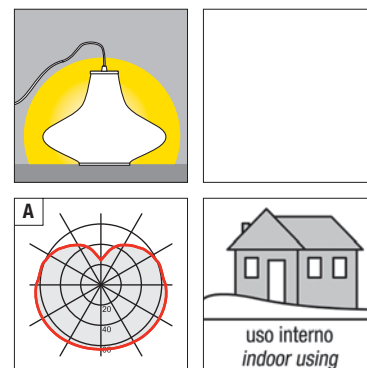

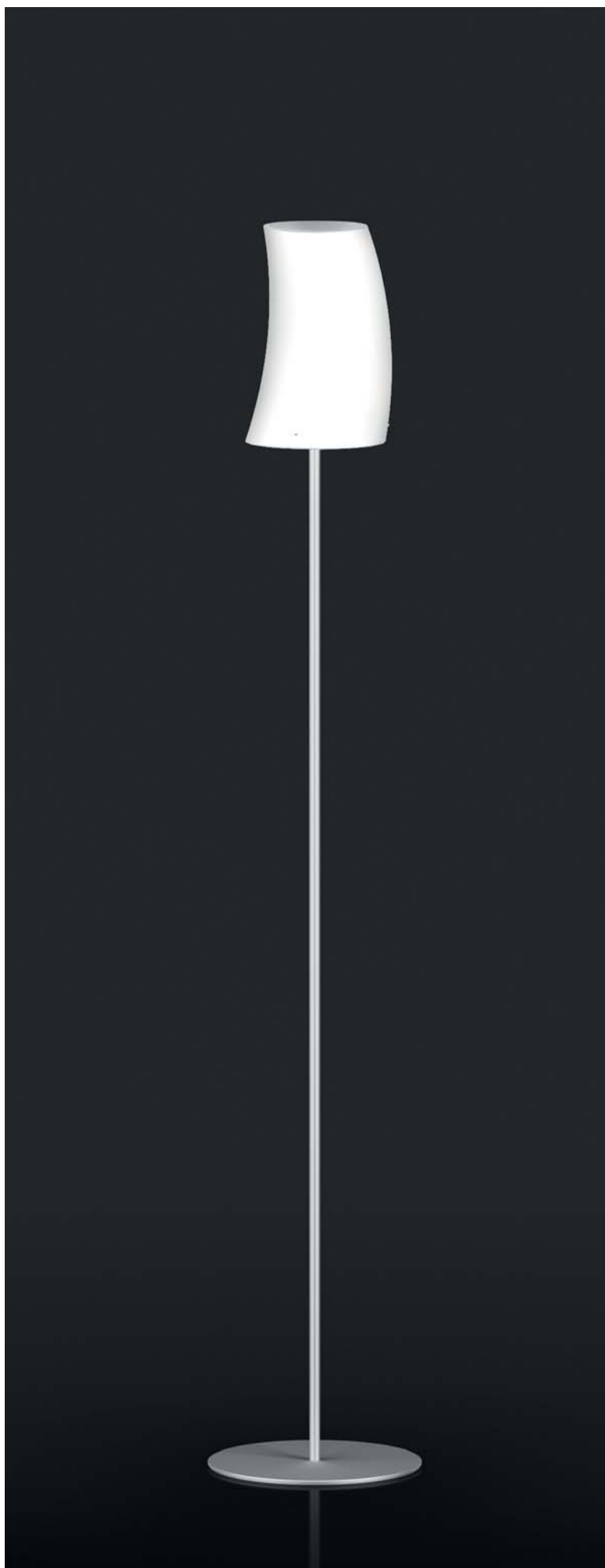

Girotondo

Lampada da tavolo e da terra. Diffusore in vetro soffiato opale triplex satinato. Struttura in metallo verniciato alluminio ral 9006. Particolari in metallo cromato. La lampada da terra é fornita con regolatore di intensità luminosa.

Table lamp and floor lamp. Diffuser made in blown satin opal triplex glass. Structure in metal painted aluminium ral 9006. Details in chrome plated metal. Floor lamp equipped with dimmer.

Lampe de table et lampadaire. Diffuseur en verre soufflé opale triplex satiné. Structure réalisée en métal vernie couleur aluminium ral 9006. Détails en métal chromé. Lampadaire équipée avec variateur.

Lámpara de mesa e de pie. Difusor de vidrio soplado opal triplex satinado. Estructura en metal pintado aluminio ral 9006. Detalles en metal cromado. Lámpara de pie suministrada con regulador de intensidad luminosa.

Tischlampe und Stehlampe. Diffusor aus geblasenem Triplex-Opalglas, satiniert. Struktur aus Aluminium lackiertem Metall Ral 9006. Einzelteile aus verchromtem Metall. Stehlampe mit Leuchtstärkenregler.

Colore vetro Glass color

OP

W_{max}



LUMEN



LUMEN/W



Girotondo/G

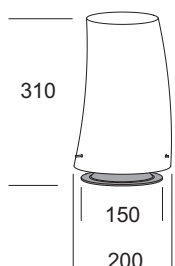

Articolo Item	Codice Code	W _{max}	Icon	LUMEN	Icon	LUMEN/W	Icon
E27 girotondo/G	85151	1x77	E27	1320	IP20	□ 17	A

Girotondo/T

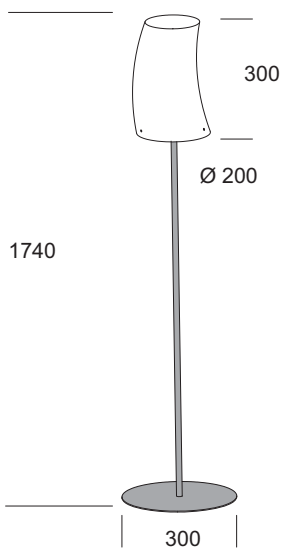

E27 girotondo/T	81201	1x205	E27	4200	IP20	□ 20	A
-----------------	-------	-------	-----	------	------	------	---



Colore vetro Glass color

OP

Opale satinato *Satin opal*

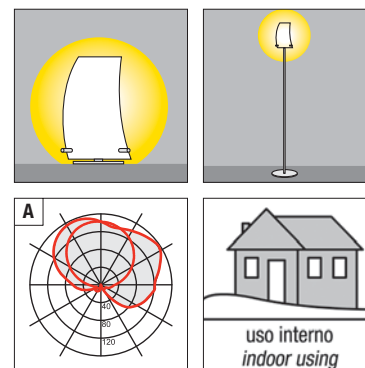

Nordica

Lampada da terra. Diffusore in vetro soffiato opale triplex lucido. Struttura in metallo cromato. Fornita con regolatore di intensità luminosa.

Floor lamp. Diffuser made in blown shiny opal triplex glass. Structure made in chrome plated metal. Equipped with dimmer.

Lampadaire. Diffuseur en verre soufflé opale triplex brillant. Structure réalisée en métal chromé. Equipée avec variateur.

Lámpara de pie. Difusor de vidrio soplado opal triplex brillante. Estructura en metal cromado. Suministrada con regulador de intensidad luminosa.

Stehlampe. Diffusor aus geblasenem Triplex-Opalglas, glänzend. Struktur aus verchromtem Metall. Mit Leuchtstärkenregler.



Nordica/T2

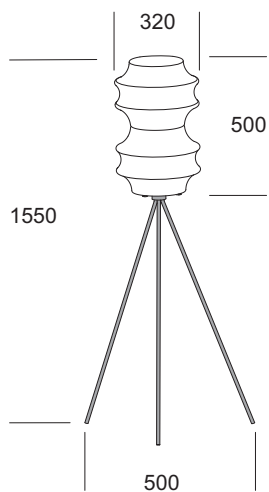

Articolo <i>Item</i>	Colore vetro <i>Glass color</i>		W _{max}		LUMEN		LUMEN/W	
	OP	Codice <i>Code</i>						
E27 nordica/T2		81341	1x205	E27	4200	IP20	20	A

Colore vetro *Glass color*

OP
Opale lucido *Shiny opal*

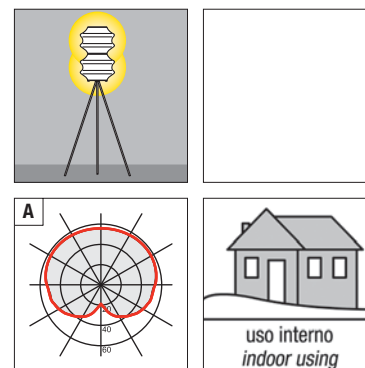

Ti-light

Lampada da terra. Diffusore in vetro Pirex satinato. Struttura in metallo cromato. Fornita con regolatore di intensità luminosa.

Floor lamp. Diffuser made in Pyrex glass with sandblasted surface. Structure made in chrome plated metal. Equipped with dimmer.

Lampadaire. Diffuseur en verre Pyrex satiné. Structure réalisée en métal chromé. Equipée avec variateur.

Lámpara de pie. Difusor de vidrio Pirex satinado. Estructura en metal cromado. Suministrada con regulador de intensidad luminosa.

Stehlampe. Diffusor aus satiniertem Pyrexglas. Struktur aus verchromtem Metall. Mit Leuchtstärkenregler.

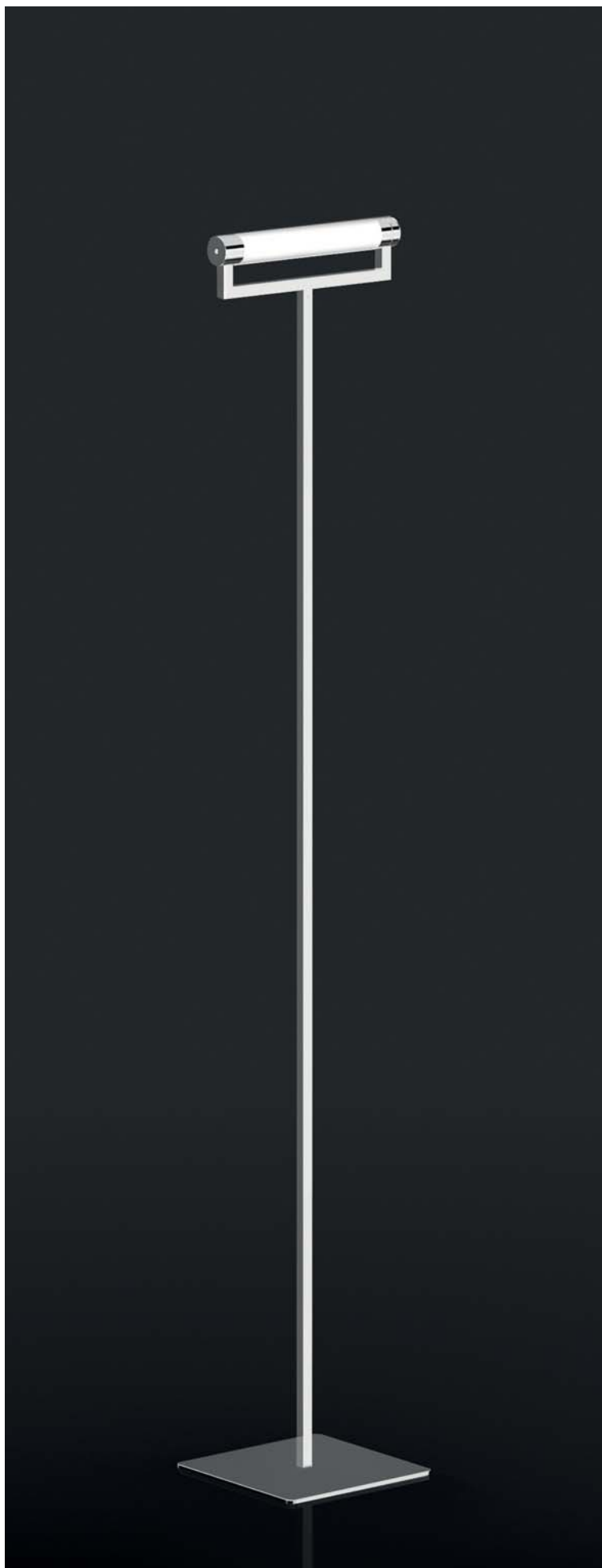

Ti-light/T

Colore struttura Structure color

Articolo Item

CR

W_{max}



LUMEN



LUMEN/W



Codice Code

HL	ti-light/T	81370	1x230	R7s	5000	IP20	□	22	A
----	------------	-------	-------	-----	------	------	---	----	---

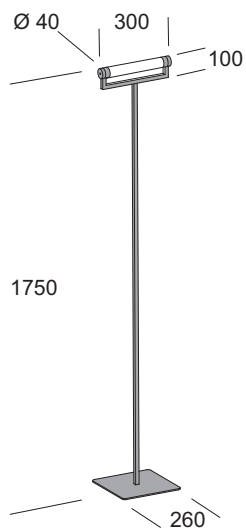

Colore struttura Structure color

CR

Cromato Chrome

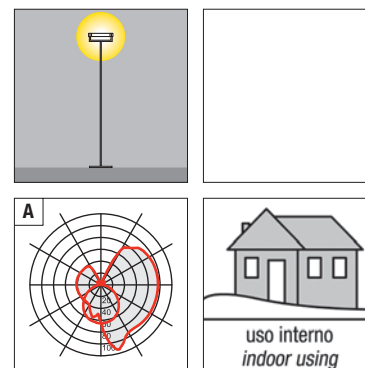

Vitrum

Lampada da terra. Diffusore in cristallo extrachiario trasparente temperato sabbiato internamente. Struttura in metallo verniciato bianco ral 9016. Parabola riflettente in metallo bianco. **Versione LED equipaggiata con led smd e alimentatore elettronico incorporato.**

Floor lamp. Diffuser in extra-clear transparent tempered crystal with sandblasted inside surface. Structure made in metal painted white ral 9016. White painted metal reflector. **LED version equipped with smd led and electronic driver included.**

Lampadaire. Diffuseur en cristal extra clair transparent trempé et satiné intérieurement. Structure réalisée en métal vernie couleur blanc ral 9016. Réflecteur en métal verni blanc. **Version LED équipée avec led smd et ballast électronique incorporé.**

Lámpara de pie. Difusor de cristal extraclaro transparente templado arenado internamente. Estructura de metal pintado blanco ral 9016. Parábola reflectante en metal blanco. **Version LED suministrada con led smd y alimentador electronico incluido.**

Stehlampe. Diffusor aus extrahellem transparentem Kristallglas, temperiert und innen sandgestrahlt. Struktur aus weiß lackiertem Metall Ral 9016. Reflex-Parabolspiegel aus weißem Metall. **Ausführung LED zum led smd und integriert Versorgungsgerät elektronisch.**

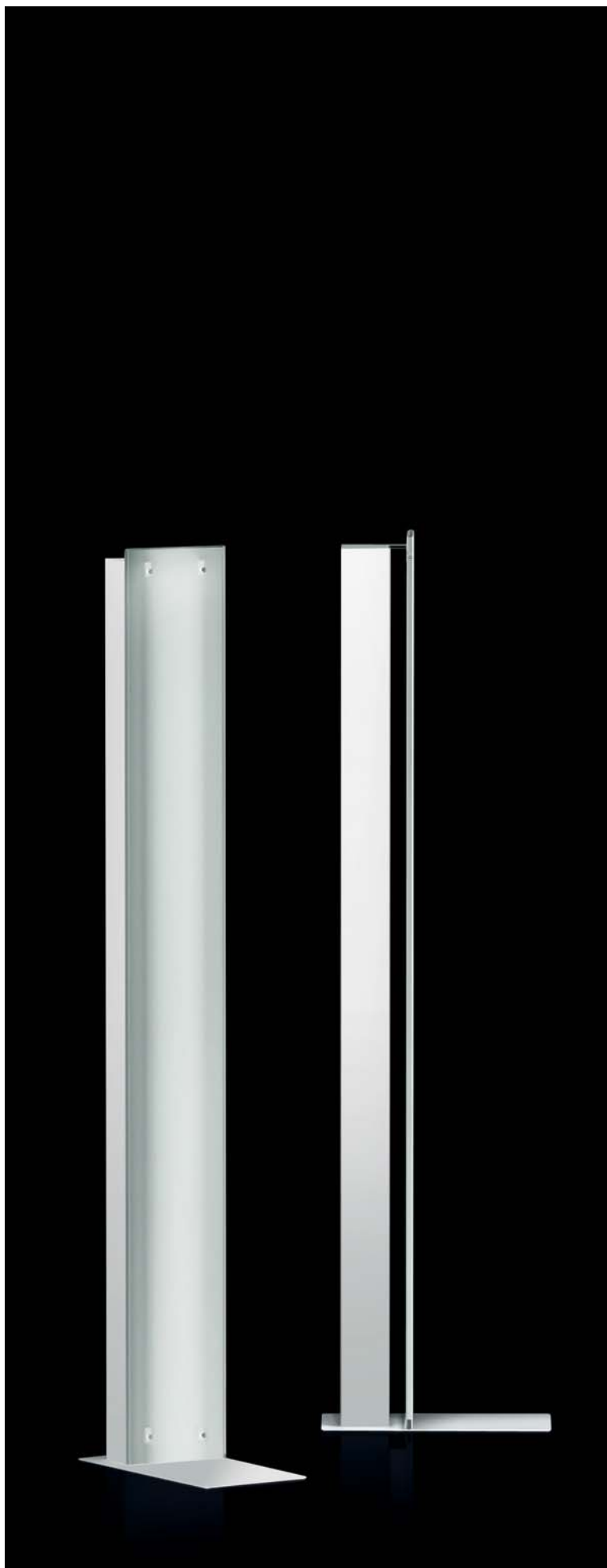

Vitrum

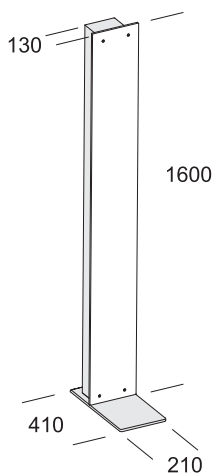

Colore struttura Structure color

Articolo Item	BI	W _{max}		LUMEN		LUMEN/W	
	Codice Code						
● Led vitrum led-W	81611	31,2	led	4470	IP20	143	A
● Led vitrum led-N	81621	31,2	led	4470	IP20	143	A
EL vitrum	81391	1x80	G5	7000	IP20	87	A

Colore struttura Structure color

BI **RAL 9016**
Bianco opaco *Matt white*

● Nuova versione *New version*

- Led Equipaggiata con led 3000K - *Equipped with led 3000K*
- Led Equipaggiata con led 4000K - *Equipped with led 4000K*

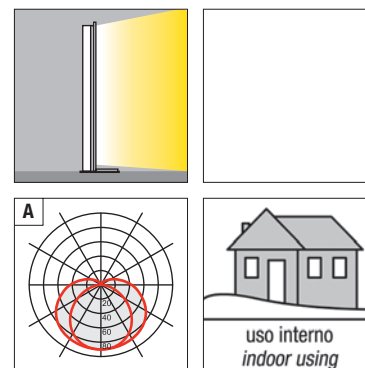

14 applique interni/esterni
wall lights indoor/outdoor

150 plafoniere interni/esterni
ceiling bowls indoor/outdoor

248 testata letto
bed head units

258 sospensioni
suspensions

344 lampade
lamps

384 lampioni ed incassi
bollards & recessed lights

450 indice
index



Chrome

Lampada da tavolo. Paralume in policarbonato traslucido cromato o in tessuto ignifugo autoestinguente colore nero. Struttura in metallo cromato.

Table lamp. Shade made of chrome translucent polycarbonate or auto extinguishing end not inflammable cloth black colour. Structure made in chrome plated metal.

Lampe de table. Abat-jour en polycarbonate translucide chrome ou en tissu noir ignifuge et à extinction automatique. Structure réalisée en métal chromé.

Lámpara de mesa. Pantalla de policarbonato translúcido cromado o en tejido ignífugo autoextinguible color negro. Estructura en metal cromado.

Tischlampe. Lampenschirm aus verchromtem transluzent Polycarbonat oder schwarzfarben, feuerfestes selbstlöschendes Gewebe. Struktur aus verchromtem Metall.

Chrome/G CR

Chrome/G

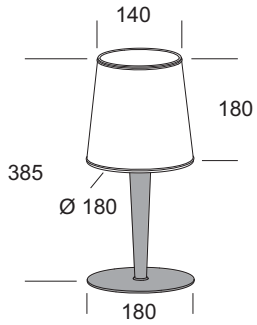

Articolo <i>Item</i>	Colore paralume <i>Shade color</i>		W _{max}		LUMEN		LUMEN/W	
	CR	NE						
	Codice <i>Code</i>							
E27 chrome/G	85340	85347	1x77	E27	1320	IP20	17	A



Colore paralume *Shade color*

CR Cromato <i>Chrome</i>	NE Nero <i>Black</i>
------------------------------------	--------------------------------

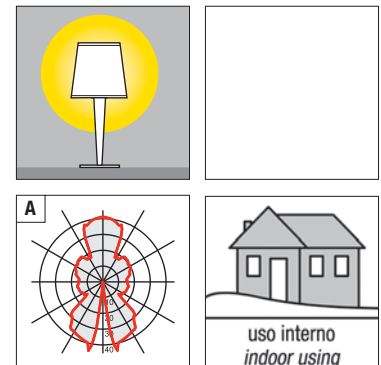



Dado plissé/G

Dado

Lampada da tavolo.

Dado plissé: paralume realizzato in tessuto pongé fasciato ignifugo autoestinguente colore avorio. Struttura in metallo cromato o verniciato colore avorio opaco ral 9001.

Dado: paralume in tessuto ignifugo autoestinguente marrone. Struttura in metallo cromato.

Table lamp.

Dado plissé: shade made in auto extinguishing end not inflammable pongé fabric binding ivory colour. Structure made in chrome plated metal or ivory matt painted metal ral 9001.

Dado: shade made in auto extinguishing end not inflammable cloth brown colour. Structure made in chrome plated metal.

Lampe de table.

Dado plissé: abat-jour en tissu pongé bandé ignifuge et à extinction automatique couleur ivoire. Structure réalisée en métal chromé ou vernie ivoire opaque ral 9001.

Dado: abat-jour en tissu marron ignifuge et à extinction automatique. Structure réalisée en métal chromé.

Lámpara de mesa.

Dado plissé: pantalla en cinta de tejido pongé ignifugo autoextinguible color marfil. Estructura en metal cromado o pintado marfil opaco ral 9001.

Dado: pantalla de tejido ignifugo autoextinguible color marrón. Estructura en metal cromado.

Tischlampe.

Dado plissé: Lampenschirm aus Pongé Stoff-Band elfenbeinfarben, feuerfestes selbstlöschendes Gewebe. Struktur aus verchromtem Metall oder Mattelfenbein lackiertem Metall Ral 9001.

Dado: Lampenschirm braunfarben, feuerfestes selbstlöschendes Gewebe. Struktur aus verchromtem Metall.

Dado plissé/G

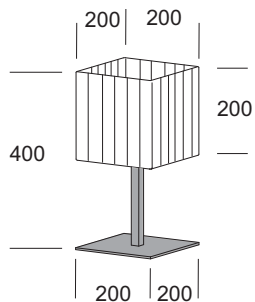

Colore struttura Structure color

Articolo Item

CR **AV**

W_{max}



LUMEN



LUMEN/W



Codice Code

E27	dado plissé/G	85360	85362	1x77	E27	1320	IP20		17	A
------------	----------------------	-------	-------	------	-----	------	------	--	----	---

Dado/G

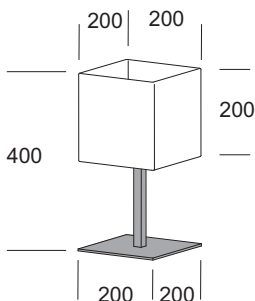

CR

E27	dado/G	85368		1x77	E27	1320	IP20		17	A
------------	---------------	-------	--	------	-----	------	------	--	----	---



Colore struttura Structure color

CR
Cromato Chrome

AV RAL 9001
Avorio Ivory

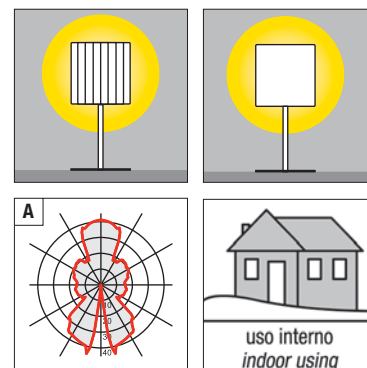



Retrò

Lampada da tavolo e da terra. Paralume in tessuto ignifugo autoestinguente colore avorio. Struttura in metallo cromato o dorato. **La finitura può cambiare a richiesta del cliente.**

Table lamp and floor lamp. Shade made in auto extinguishing end not inflammable cloth ivory colour. Structure made in chrome plated metal or gold plated metal. **Finish can change based on client request.**

Lampe de table et lampadaire. Abat-jour en tissu ivoire ignifuge et à extinction automatique. Structure réalisée en métal chromé ou en métal doré. **La finition peu changé selon la demande du client.**

Lámpara de mesa e de pie. Pantalla en tejido ignífugo autoextinguible color marfil. Estructura de metal cromado o de metal dorado. **Acabado puede cambiar a petición del cliente.**

Tischlampe und Stehlampe. Lampenschirm elfenbeinfarben, feuerfestes selbstlöschendes Gewebe. Struktur aus verchromtem Metall oder vergoldetem Metall. **Die Farben können auf die Bedürfnisse des Kunden abgestimmt werden.**

Retrò/G

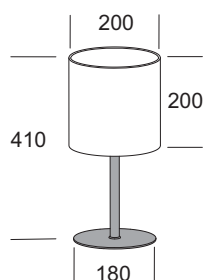

Articolo <i>Item</i>	Colore struttura <i>Structure color</i>		W _{max}		LUMEN		LUMEN/W	
	CR	OR						
	Codice <i>Code</i>							
E27 retrò/G	85350	85352	1x77	E27	1320	IP20	17	A

Retrò/T

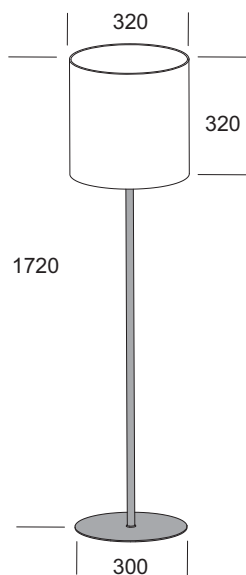

E27 retrò/T	81540	81542	1x116	E27	2135	IP20	18	A
-------------	-------	-------	-------	-----	------	------	----	---



Colore struttura *Structure color*

CR	OR
Cromato <i>Chrome</i>	Dorato 24K <i>Gold plated 24K</i>

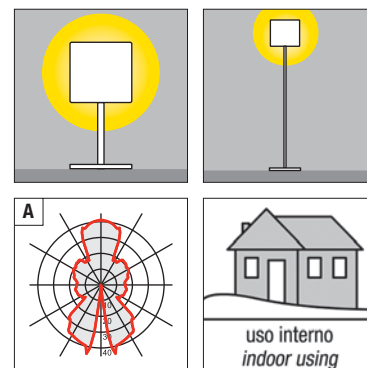



Trilyum

Lampade da tavolo e da terra. Diffusore in polipropilene con serigrafia colore avorio. Struttura in metallo verniciato alluminio ral 9006. La lampada Trilyum/G è fornita con interruttore a tirante. Lampada da terra fornita con regolatore di intensità luminosa e interruttore a tirante.

Table lamps and floor lamp. Diffuser made in polypropylene with serigraphy ivory colour. Structure made in aluminium painted metal ral 9006. Lamp Trilyum/G is equipped with tie rod switch. Floor lamp equipped with dimmer and with tie rod switch.

Lampes de table et lampadaire. Diffuseur en polypropylène avec sérigraphie couleur ivoire. Structure réalisée en métal vernie couleur aluminium ral 9006. Lampe Trilyum/G est équipée avec interrupteur à tirant. Lampadaire avec variateur et interrupteur à tirant.

Lámparas de mesa e de pie. Difusor de polipropileno con serigrafía color marfil. Estructura en metal pintado aluminio ral 9006. Lámpara Trilyum/G es suministrada con interruptor de tirante. Lámpara de pie suministrada con regulador de intensidad luminosa e interruptor de tirante.

Tischlampen und Stehlampe. Diffusor aus Polypropylen mit Siebdruck, elfenbeinfarben. Struktur aus Aluminium lackiertem Metall Ral 9006. Lampe Trilyum/G mit Ziehschalter. Stehlampe mit Leuchtstärkenregler und Ziehschalter.

Trilyum/P

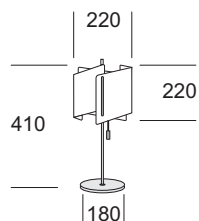

Articolo Item	Codice Code	W _{max}		LUMEN		LUMEN/W	
E14 trilyum/P	88160	1x46	E14	700	IP20	15	A

Trilyum/G

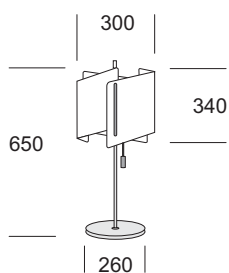

E27 trilyum/G	85280	1x116	E27	2135	IP20	18	A
---------------	-------	-------	-----	------	------	----	---

Trilyum/T

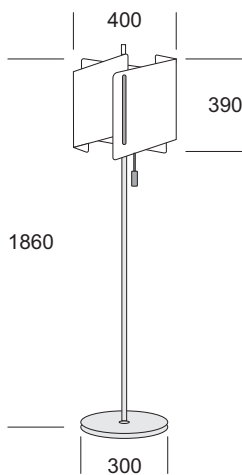

E27 trilyum/T	81380	1x205	E27	4200	IP20	20	A
---------------	-------	-------	-----	------	------	----	---

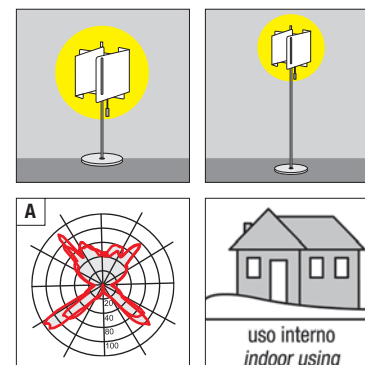

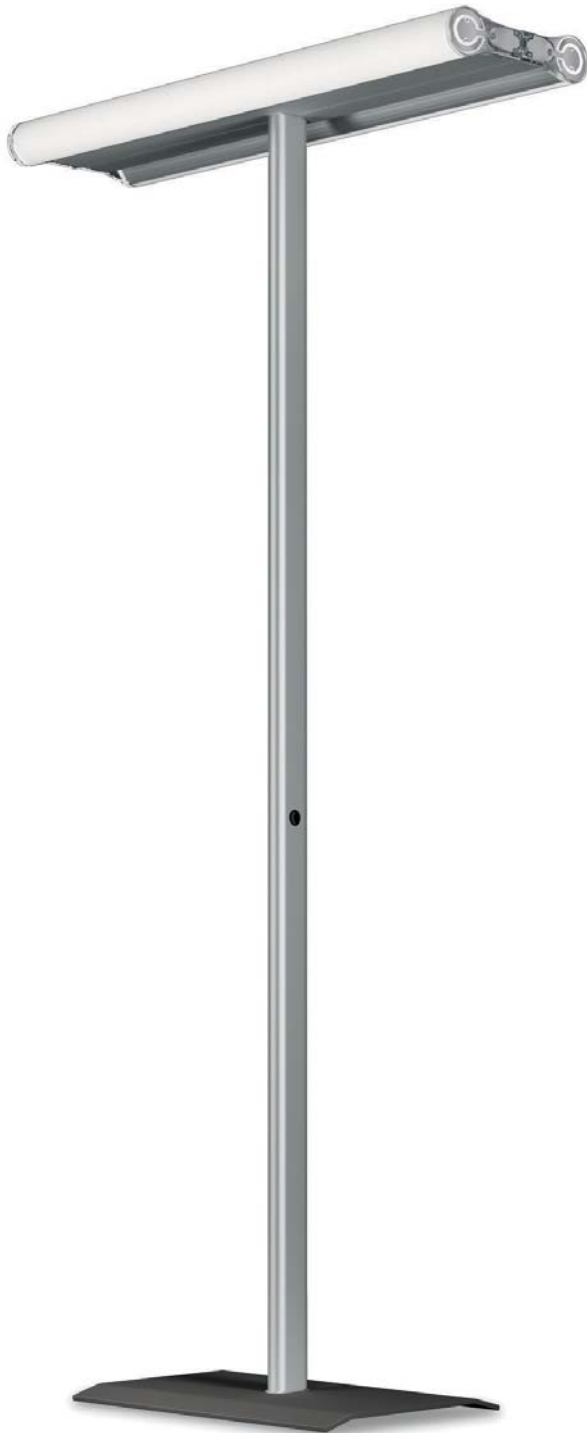

Duo T

Lampada da terra. Diffusori in policarbonato colore anice. I diffusori ruotano di 360° permettendo di orientare il fascio luminoso. Struttura in alluminio estruso e metallo verniciato grigio gofrato ral 9006. Particolari in policarbonato trasparente e metallo cromato. Base in metallo verniciato antracite gofrato. **Versione LED equipaggiata con led smd e alimentatore elettronico incorporato.**

Floor lamp. Diffusers in made polycarbonate colour anise. Diffusers rotate on 360 degree permitting to orientate the luminous beam. Structure made in extruded aluminium and painted metal colour embossed grey ral 9006. Details made in transparent polycarbonate and chrome metal plated. Base realised in painted metal colour embossed anthracite. **LED version equipped with smd led and electronic driver included.**

Lampadaire. Diffuseurs in polycarbonate couleur anis. Les diffuseurs tournent de 360 degré permettant d'orienter le flux lumineux. Structure réalisée en extrusion d'aluminium et en métal vernie gris gaufré ral 9006. Détails en polycarbonate transparent et métal chromé. Base en métal couleur anthracite gaufré. **Versión LED équipée avec led smd et ballast électronique incorporé.**

Lámpara de pie. Difusor de policarbonato color anís. El difusor gira en 360° permitiendo orientar el rayo luminoso. Estructura en aluminio extrudido y en metallo pintado gris rugoso ral 9006. Detalles de policarbonato transparente y metal cromado. Base de metal color antracita rugoso. **Versión LED suministrada con led smd y alimentador electrónico incluido.**

Stehlampe. Diffusoren aus anisfarbenem Polycarbonat. Die Diffusoren drehen sich um 360° und ermöglichen somit die Ausrichtung der Lichtstrahl. Struktur aus Aluminium extrusion und aus gaufriert grau lackiertem Metall Ral 9006. Einzelteile aus transparentem Polycarbonat und verchromtem Metall. Basis aus Metall mit gaufriert anthrazitfarbener Lackierung. **Ausführung LED zum led smd und integriert Versorgungsgerät elektronisch.**

Duo/T

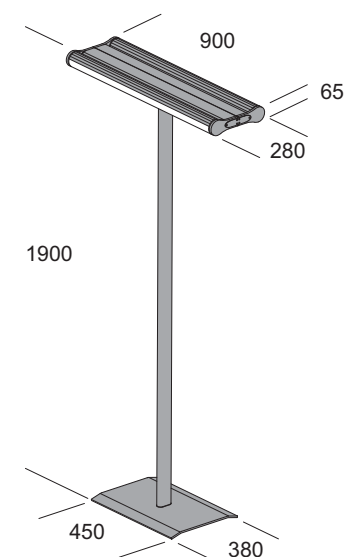

Colore struttura Structure color

Articolo Item	GR	W _{max}		LUMEN		LUMEN/W	
	Codice Code						
● Led duo/T led-W	81636	68,8	led	9380	IP20	⊕	136 A
● Led EM duo/T EM led-W	81656	68,8	led	9380	IP20	⊕	136 A
● Led duo/T led-N	81646	68,8	led	9380	IP20	⊕	136 A
● Led EM duo/T EM led-N	81666	68,8	led	9380	IP20	⊕	136 A
EL duo/T	81446	4x39	G5	14000	IP20	⊕	90 A
EM duo/T EM	81466	4x39	G5	14000	IP20	⊕	90 A

Colore struttura Structure color

GR RAL 9006
Grigio gofrato Embossed grey

● Nuova versione New version

Led Equipaggiata con led 3000K - Equipped with led 3000K

Led Equipaggiata con led 4000K - Equipped with led 4000K

Led EM **Led EM** **EM** Emergenza (SA) 1h di serie – 3h a richiesta
Emergency 1h standard – 3h on request

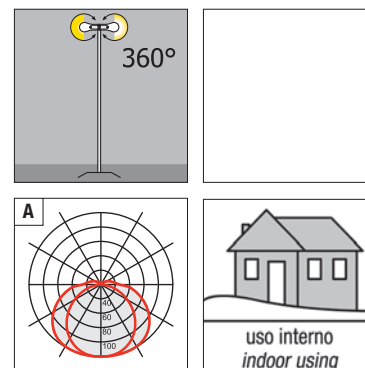



Tris

Lampada da terra. Diffusori in policarbonato colore anice. I diffusori ruotano di 360° permettendo di orientare il fascio luminoso. Struttura in alluminio estruso anodizzato e in metallo verniciato alluminio ral 9006. Particolari in policarbonato trasparente e metallo cromato. Fornita di interruttore per accensioni separate (2+1). Alimentatore elettronico incorporato.

Floor lamp. Diffusers in made polycarbonate colour anise. Diffusers rotate on 360 degree permitting to orientate the luminous beam. Structure made in extruded oxidized aluminium and painted metal colour aluminium ral 9006. Details made in transparent polycarbonate and chrome metal plated. Equipped with switch for separate lightings (2+1). Electronic driver included.

Lampadaire. Diffuseurs in polycarbonate couleur anis. Les diffuseurs tournent de 360 degré permettant d'orienter le flux lumineux. Structure réalisée en extrusion d'aluminium anodisé et en métal vernie aluminium ral 9006. Détails en polycarbonate transparent et métal chromé. Equipée d'interrupteur pour allumages séparés (2+1). Ballast électronique incorporé.

Lámpara de pie. Difusor de policarbonato color anís. El difusor gira en 360° permitiendo orientar el rayo luminoso. Estructura en aluminio extrudido oxidado y en metal pintado aluminio ral 9006. Detalles de policarbonato transparente y metal cromado. Suministrada con interruptor para encendidos separados (2+1). Alimentador electrónico incluido.

Stehlampe. Diffusoren aus anisfarbenem Polycarbonat. Die Diffusoren drehen sich um 360° und ermöglichen somit die Ausrichtung der Lichtstrahl. Struktur aus anodisiert Aluminium extrusion und aus Aluminium lackiertem Metall Ral 9006. Einzelteile aus transparentem Polycarbonat und verchromtem Metall. Mit Schalter zum getrennten Einschalten (2+1). Eingebautem elektronischem Versorgungsgerät.

Tris

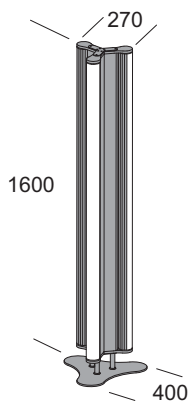

Colore struttura Structure color

Articolo Item

AL

W_{max}



LUMEN



LUMEN/W



Codice Code

EL	tris 3x80	81436	3x80	G5	21000	IP20	⊕	87
----	-----------	-------	------	----	-------	------	---	----



Colore struttura Structure color

AL

Alluminio anodizzato Oxidized aluminium

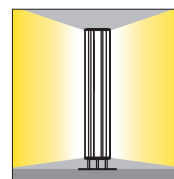
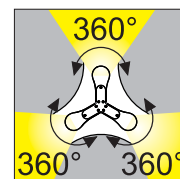

Lampioni ed incassi - *Bollards & recessed lights*

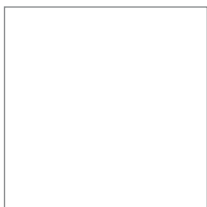

Paloled 388



Kuba-Kubamini 390



Step 2/30-60 400



Step 3/30-60 400



Kit 1/60-100 404



Kit 2/60-100 404



Nano 408



Isy 410



Plaza 428



Box 432



Polo 60-90 438



Alfa 440



Alfa 440





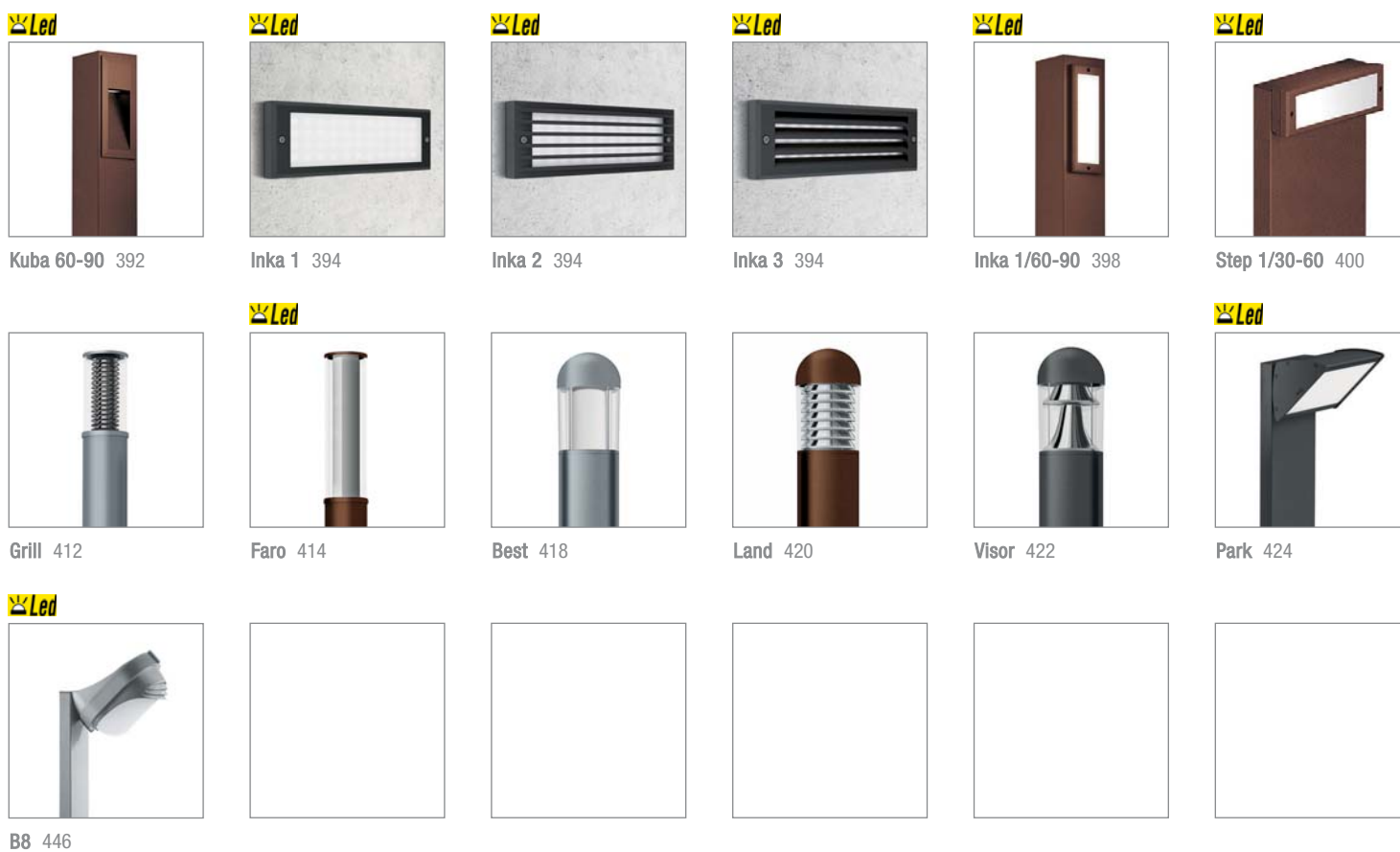

B4 446



NEW Nuovo prodotto *New product*

 **Versione LED** *LED version*

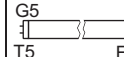
 **Versione RGB** *RGB version*

Gx24d/Gx24q TC-T/TC-TE 		2G11 TC-L/TC-LE 		G5 T5 FDH 		LED 	RGB 	EMERGENZA EMERGENCY	PAG./PAGE	ARTICOLO/ITEM
1 X	2 X	1 X	2 X	2 X						
						3,5...8,0			440	A SERIE ALFA
						6,3/12,6			446	B4-B8
42						21			418	BEST
			36	24/54/80		23...114,6			432	BOX
		24				6,2/11,5			414	FARO
		24							412	GRILL
						6,3			394	INKA 1/2/3
						6,3/12,6			398	INKA 1/60-90
		24							410	ISY
26	26					12,6/25,2			404	KIT 60-100
						3,5/6,3			445	K SERIE K
42						4/6,3		○	390	KUBA/KUBAMINI
						4			392	KUBA/60-90
42									420	LAND
						5,6			408	NANO 12-35
						6/12/24			388	PALOLED
						23/46			424	PARK
						23/46			428	PLAZA
						13,5/27			438	POLO/60-10
						6,3/12,6			400	STEP 30 - 60
42									422	VISOR

14 applique interni/esterni
wall lights indoor/outdoor

150 plafoniere interni/esterni
ceiling bowls indoor/outdoor

248 testaletto
bed head units

258 sospensioni
suspensions

344 lampade
lamps

384 lampioni ed incassi
bollards & recessed lights

450 indice
index

Paloled

Lampione da giardino. Diffusore in policarbonato opale. Palo in alluminio estruso con particolari in pressofusione di alluminio, verniciatura in polvere poliestere con trattamento di fosfatazione. Viti in acciaio inox. Guarnizioni in gomma ai polimeri. Fornito con dispositivo per il collegamento di un cavo di ingresso (alimentazione della rete) e due cavi di uscita (alimentazione degli apparecchi a "cascata" in parallelo). **Equipaggiato con led smd e alimentatore elettronico incorporato.**

Bollard. Diffuser made in opal polycarbonate. Pole made in extruded aluminium and die casting aluminium parts with polyester paint and phosphate treatment. Inox steel screws. Gasket made in rubber. Equipped with a device for connecting an input cable (mains supply) and two output cables (power to devices in "cascade" in parallel). **Equipped with smd led and electronic driver included.**

Borne. Diffuseur en polycarbonate opale. Pilier réalisé en extrusion d'aluminium avec parties en fonte d'aluminium. Vernis polyester traitement de phosphatation. Vis en acier inox. Joint en gomme. Equipé d'un dispositif permettant de connecter un câble d'entrée (alimentation secteur) et de deux câbles de sortie (puissance aux dispositifs de la "cascade" en parallèle). **Equipé avec led smd et ballast électronique incorporé.**

Baliza. Difusor de policarbonato opal. Poste de aluminio extrudido con detalles fundidos a presión de aluminio, pintura en polvo poliéster con tratamiento de fosfatación. Tornillos de acero inoxidable. Junta de protección de goma. Suministrado con un dispositivo para conectar un cable de entrada (red eléctrica) y dos cables de salida (energía a los dispositivos en "cascada" en paralelo). **Suministrada con led smd y alimentador electrónico incluido.**

Pollerleuchte. Diffusor aus opalem Polycarbonat. Ständer aus Aluminium extrusion mit Einzelteilen aus Aludruckguss, Lackierung aus Polyester Pulver mit Phosphatierung. Schrauben aus Edelstahl. Dichtungen aus Polymergummi. Ausgestattet mit einer Vorrichtung zum Anschließen einer Eingangsspannung Kabel (Netz) und zwei Output-Kabel (Stromversorgung von Geräten in "Kaskade" parallel). Ausgestattet mit LED smd. **Eingebautem elektronischem**

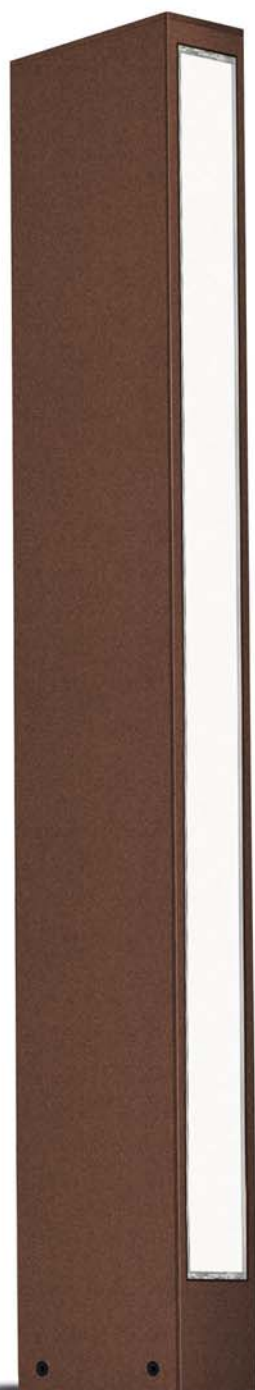

Colore struttura Structure color

Paloled 60 - 62

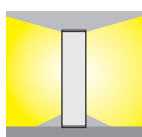
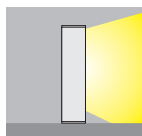
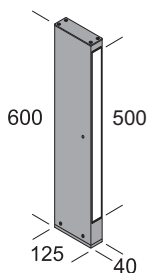

Articolo Item	Colore struttura Structure color			W _{max}	LUMEN	IP	LUMEN/W	A
	AT	GR	RU					
● Led paloled 60 led-W	59927	59926	59928	6	led	800	IP65	⊕ 133
	59937	59936	59938					
● Led paloled 62 led-W	59947	59946	59948	12	led	1600	IP65	⊕ 133
	59957	59956	59958					

Paloled 110 - 112

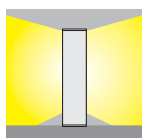
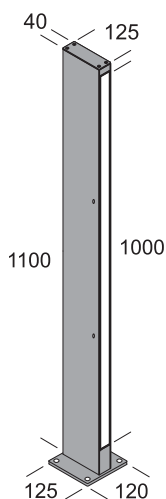

● Led paloled 110 led-W	59967	59966	59968	12	led	1600	IP65	⊕ 133
	59977	59976	59978					
● Led paloled 112 led-W	59987	59986	59988	24	led	3200	IP65	⊕ 133
	59997	59996	59998					

Colore struttura Structure color

● Nuova versione New version

AT RAL 7016
Antracite gofrato Embossed anthracite

GR RAL 9006
Grigio gofrato Embossed grey

● **RU**
Ruggine Rust

● Led Equipaggiata con led 3000K - Equipped with led 3000K

● Led Equipaggiata con led 4000K - Equipped with led 4000K

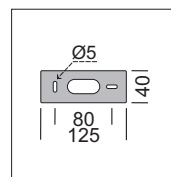

base paloled 60-62

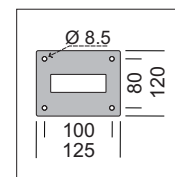

base paloled 110-112

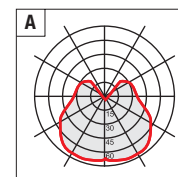



Kuba - Kubamini

Lampada da incasso a parete dotata di doppio sistema di fissaggio anti vandalo. Diffusore in vetro temperato satinato internamente. Struttura in pressofusione di alluminio, verniciatura in polvere poliesteri con trattamento di fosfatazione. Viti in acciaio inox. Guarnizioni in gomma ai polimeri. Cassaforma in polipropilene da installare nel muro, acquistabile separatamente.

Kuba: versione LED equipaggiata con led smd e alimentatore elettronico incorporato.

Kubamini: equipaggiata con led di potenza e alimentatore elettronico incorporato.

Wall recessed lamp equipped with dual mounting anti vandal. Diffuser made in tempered glass with satin inside surface. Structure made in die casting aluminium with polyester paint and phosphate treatment. Inox steel screws. Gasket made in rubber. Recessing box, purchasable separately, made in Polypropylene to install in the wall

Kuba: LED version equipped with smd led and electronic driver included.

Kubamini: equipped with power led and electronic gear included

Lampe à encastre mural équipé de fixation double anti vandalisme. Diffuseur en verre tempéré satiné à l'intérieur. Structure réalisée en fonte d'aluminium. Vernis polyester traitement de phosphatation. Vis en acier inox. Joint en gomme. Boîtier d'encastrement mural, vendu séparément, réalisé en polypropylène.

Kuba: version LED équipée avec led smd et ballast électronique incorporé.

Kubamini: équipée avec led de puissance et ballast électronique incorporé.

Lampara de empotrar a pared equipada con doble sistema de fijación anti vandalismo. Difusor de vidrio templado arenado internamente. Estructura en fundición a presión de aluminio, pintura en polvo poliéster con tratamiento de fosfatación. Tornillos de acero inoxidable. Junta de protección de goma. Caja de empotrar a pared, que se vende separado y hechas en tecnopolimero.

Kuba: version LED suministrada con led smd y alimentador electrónico incluido.

Kubamini: suministrada con led de potencia y alimentador electrónico incorporado.

Wandeinbauleuchte mit Dual Befestigungssystem antivandalensicher. Diffusor aus temperiertem Glas, innen satiniert. Struktur aus Aludruckguss, Lackierung aus Polyesterpulver mit Phosphatierung. Schrauben aus Edelstahl. Dichtungen aus Polymergummi. Polypropylenschalung zur Wandinstallation und separat erhältlich.

Kuba: Ausführung LED zum led smd und integriert Versorgungsgerät elektronisch.

Kubamini: Ausgestattet mit LED power und eingebautem elektronischem Versorgungsgerät.

Kuba

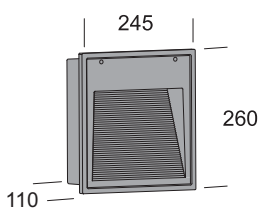

Colore struttura Structure color

Articolo Item

AT

BI

GR

RU

W_{max}



LUMEN



LUMEN/W



Codice Code

Articolo Item	AT	BI	GR	RU	W _{max}	LUMEN	LUMEN/W
E27 kuba	91077	91071	91076	91078	1x20FBT	E27 1200 IP54	60 A
● Led kuba led-W	93227	93221	93226	93228	6,3	led 750 IP54	119 A
● Led kuba led-N	93237	93231	93236	93238	6,3	led 750 IP54	119 A
EL kuba EL	92157	92151	92156	92158	1x42(a)	GX24q-4 3200 IP54	76 B
EM kuba EM	92167	92161	92166	92168	1x42(a)	GX24q-4 3200 IP54	76 B

Kubamini

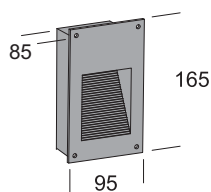

● Led kubamini led-W	93217	93211	93216	93218	4	led 360 IP54	90 C
● Led kubamini led-N	93207	93201	93206	93208	4	led 360 IP54	90 C

Cassaforma Kuba

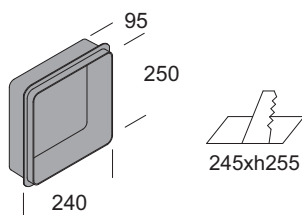

cassaforma kuba 93997 cassaforma – recessing box

Cassaforma Kubamini

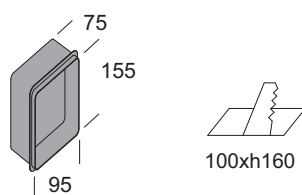

cassaforma kubamini 93977 cassaforma – recessing box

Colore struttura Structure color

AT **RAL 7016**

Antracite gofrato *Embossed anthracite*

BI **RAL 9016**

Bianco gofrato *Embossed white*

GR **RAL 9006**

Grigio gofrato *Embossed grey*

● **RU**

Ruggine Rust

● Nuova versione *New version*

● Led Equipaggiata con led 3000K - *Equipped with led 3000K*

● Led Equipaggiata con led 4000K - *Equipped with led 4000K*

EM Emergenza (SA) 1h di serie – 3h a richiesta.
Emergency 1h standard – 3h on request

(a) Equipaggiato con alimentatore multipotenza per l'utilizzo di lampade da 26W-32W o 42W
Equipped with multi-power ballast to use bulbs of 26W-32W or 42W

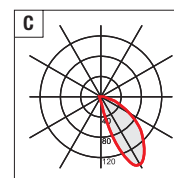
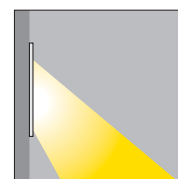
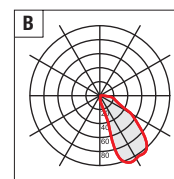
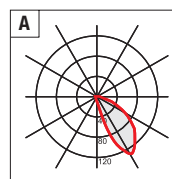

Kuba

Lampione da giardino. Diffusore in policarbonato opale. Struttura in pressofusione di alluminio, palo in alluminio estruso con particolari in pressofusione di alluminio, verniciatura in polvere poliestere con trattamento di fosfatazione. Viti in acciaio inox. Guarnizioni in gomma ai polimeri. Fornito con dispositivo per il collegamento di un cavo di ingresso (alimentazione della rete) e due cavi di uscita (alimentazione degli apparecchi a "cascata" in parallelo). **Equipaggiato con led di potenza e alimentatore elettronico incorporato.**

Bollard. Diffuser made in opal polycarbonate. Structure made in die casting aluminium, pole made in extruded aluminium and die casting aluminium parts with polyester paint and phosphate treatment. Inox steel screws. Gasket made in rubber. Equipped with a device for connecting an input cable (mains supply) and two output cables (power to devices in "cascade" in parallel). **Equipped with power led and electronic gear included.**

Borne. Diffuseur en polycarbonate opale. Structure réalisée en fonte d'aluminium, pilier réalisé en extrusion d'aluminium avec parties en fonte d'aluminium. Vernis polyester traitement de phosphatation. Vis en acier inox. Joint en gomme. Equipé d'un dispositif permettant de connecter un câble d'entrée (alimentation secteur) et de deux câbles de sortie (puissance aux dispositifs de la "cascade" en parallèle). **Equipé avec led de puissance et ballast électronique incorporé.**

Baliza. Difusor de policarbonato opal. Estructura en fundición a presión de aluminio, poste de aluminio extrudido con detalles fundidos a presión de aluminio, pintura en polvo poliéster con tratamiento de fosfatación. Tornillos de acero inoxidable. Junta de protección de goma. Suministrado con un dispositivo para conectar un cable de entrada (red eléctrica) y dos cables de salida (energía a los dispositivos en "cascada" en paralelo). **Suministrado con led de potencia y alimentador electrónico incorporado.**

Pollerleuchte. Diffusor aus opalem Polycarbonat. Struktur aus Aludruckguss, Ständer aus Aluminium extrusion mit Einzelteilen aus Aludruckguss, Lackierung aus Polyester Pulver mit Phosphatierung. Schrauben aus Edelstahl. Dichtungen aus Polymergummi. Ausgestattet mit einer Vorrichtung zum Anschließen einer Eingangsspannung Kabel (Netz) und zwei Output-Kabel (Stromversorgung von Geräten in "Kaskade" parallel). **Ausgestattet mit LED power und eingebautem elektronischem Versorgungsgerät.**



Kuba 60

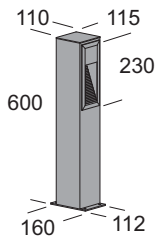

Articolo <i>Item</i>	Colore struttura <i>Structure color</i>			W _{max}		LUMEN		LUMEN/W		
	AT	GR	RU							Codice <i>Code</i>
● Led kuba 60 led-W	59887	59886	59888	4	led	360	IP54	⊕	90	A
● Led kuba 60 led-N	59897	59896	59898	4	led	360	IP54	⊕	90	A

Kuba 90

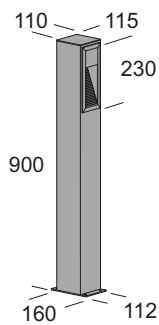

● Led kuba 90 led-W	59907	59906	59908	4	led	360	IP54	⊕	90	A
● Led kuba 90 led-N	59917	59916	59918	4	led	360	IP54	⊕	90	A

Colore struttura *Structure color*

● Nuova versione *New version*

AT **RAL 7016**
Antracite gofrato *Embossed anthracite*

GR **RAL 9006**
Grigio gofrato *Embossed grey*

● **RU**
Ruggine *Rust*

Led Equipaggiata con led 3000K - *Equipped with led 3000K*

Led Equipaggiata con led 4000K - *Equipped with led 4000K*

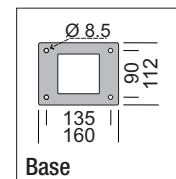

Base

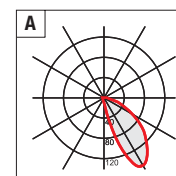
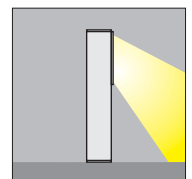

A





Inka

Lampada da incasso a parete dotata di doppio sistema di fissaggio anti vandalo. Diffusore in policarbonato opale. Struttura in pressofusione di alluminio, verniciatura in polvere poliesteri con trattamento di fosfatazione. Viti in acciaio inox. Guarnizioni in gomma ai polimeri. **Versione LED equipaggiata con led smd e alimentatore elettronico incorporato.** Cassaforma in polipropilene da installare nel muro, acquistabile separatamente.

Wall recessed lamp equipped with dual mounting anti vandal. Diffuser made in opal polycarbonate. Structure made in die casting aluminium with polyester paint and phosphate treatment. Inox steel screws. **Gaskets made in rubber. LED version equipped with smd led and electronic driver included.** Recessing box, purchasable separately, made in Polypropylene to install in the wall.

Lampe à encastrer mural équipé de fixation double anti vandalisme. Diffuseur en polycarbonate opale. Structure réalisée en fonte d'aluminium. Vernis polyester traitement de phosphatation. Vis en acier inox. Joint en gomme. **Version LED équipée avec led smd et ballast électronique incorporé.** Boîtier d'encastrement mural, vendu séparément, réalisé en polypropylène

Lampara de empotrar a pared equipada con doble sistema de fijación anti vandalismo. Difusor de policarbonato opal. Estructura en fundición a presión de aluminio, pintura en polvo poliéster con tratamiento de fosfatación. Tornillos de acero inoxidable. Junta de protección de goma. **Version LED suministrada con led smd y alimentador electrónico incluido.** Caja de empotrar a pared, que se vende separado y hechas en tecnopolimero.

Wandeinbauleuchte mit Dual Befestigungssystem antivandalensicher. Diffusor aus opalem Polycarbonat. Struktur aus Aludruckguss, Lackierung aus Polyester Pulver mit Phosphatierung. Schrauben aus Edelstahl. Dichtungen aus Polymergummi. **Ausführung LED zum led smd und integriert Versorgungsgerät elektronisch.** Polypropylenschalung zur Wandinstallation und separat erhältlich.





14 applique interni/esterni
wall lights indoor/outdoor

150 plafoniere interni/esterni
ceiling bowls indoor/outdoor

248 testaletto
bed head units

258 sospensioni
suspensions

344 lampade
lamps

384 lampioni ed incassi
bollards & recessed lights

450 indice
index

Colore struttura Structure color

AT BI GR RU **W_{max}**  LUMEN  LUMEN/W 

Codice Code

Inka 1

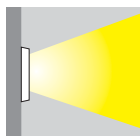
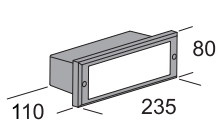

Articolo Item	AT	BI	GR	RU	W _{max}	LED	LUMEN	IP	LUMEN/W	Icon
E27 inka 1	91047	91041	91046	91048	1x11FBT	E27	630	IP65	⊕	57 A
Led inka 1 led-W	93247	93241	93246	93248	6,3	led	750	IP65	⊕	119 B
Led inka 1 led-N	93257	93251	93256	93258	6,3	led	750	IP65	⊕	119 B

Inka 2

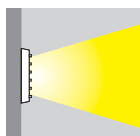
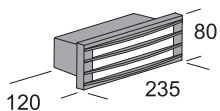

Articolo Item	AT	BI	GR	RU	W _{max}	LED	LUMEN	IP	LUMEN/W	Icon
E27 inka 2	91057	91051	91056	91058	1x11FBT	E27	630	IP65	⊕	57 C
Led inka 2 led-W	93267	93261	93266	93268	6,3	led	750	IP65	⊕	119 D
Led inka 2 led-N	93277	93271	93276	93278	6,3	led	750	IP65	⊕	119 D

Colore struttura Structure color

● Nuova versione New version

AT **RAL 7016** BI **RAL 9016** GR **RAL 9006** RU
 Antracite gofrato Embossed anthracite Bianco gofrato Embossed white Grigio gofrato Embossed grey Ruggine Rust

- Led Equipaggiata con led 3000K - Equipped with led 3000K
- Led Equipaggiata con led 4000K - Equipped with led 4000K

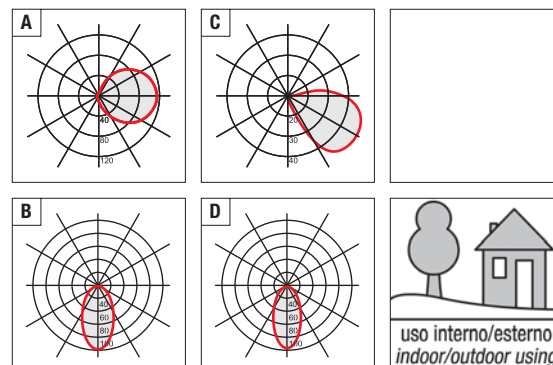

Inka 3

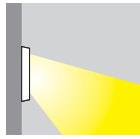
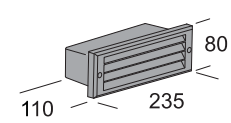

Articolo <i>Item</i>	Colore struttura <i>Structure color</i>				W _{max}		LUMEN		LUMEN/W		
	AT	BI	GR	RU							Codice <i>Code</i>
inka 3	91067	91061	91066	91068	1x11FBT	E27	630	IP65		57	E
inka 3 led-W	93287	93281	93286	93288	6,3	led	750	IP65		119	F
inka 3 led-N	93297	93291	93296	93298	6,3	led	750	IP65		119	F

Cassaforma Inka

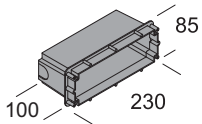

cassaforma inka	93987	cassaforma – recessing box
-----------------	-------	----------------------------

Colore struttura *Structure color*

RAL 7016 Antracite gofrato <i>Embossed anthracite</i>	RAL 9016 Bianco gofrato <i>Embossed white</i>	RAL 9006 Grigio gofrato <i>Embossed grey</i>	Ruggine Rust
---	---	--	---------------------

● Nuova versione *New version*

- Equipaggiata con led 3000K - *Equipped with led 3000K*
- Equipaggiata con led 4000K - *Equipped with led 4000K*

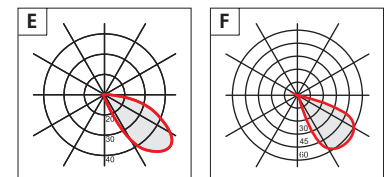

Inka

Lampione da giardino. Diffusore in policarbonato opale. Struttura in pressofusione di alluminio, palo in alluminio estruso con particolari in pressofusione di alluminio, verniciatura in polvere poliesteri con trattamento di fosfatazione. Viti in acciaio inox. Guarnizioni in gomma ai polimeri. Fornito con dispositivo per il collegamento di un cavo di ingresso (alimentazione della rete) e due cavi di uscita (alimentazione degli apparecchi a "cascata" in parallelo). **Equipaggiato con led smd e alimentatore elettronico incorporato.**

Bollard. Diffuser made in opal polycarbonate. Structure made in die casting aluminium, pole made in extruded aluminium and die casting aluminium parts with polyester paint and phosphate treatment. Inox steel screws. Gasket made in rubber. Equipped with a device for connecting an input cable (mains supply) and two output cables (power to devices in "cascade" in parallel). **Equipped with smd led and electronic driver included.**

Borne. Diffuseur en polycarbonate opale. Structure réalisée en fonte d'aluminium, pilier réalisé en extrusion d'aluminium avec parties en fonte d'aluminium. Vernis polyester traitement de phosphatation. Vis en acier inox. Joint en gomme. Equipé d'un dispositif permettant de connecter un câble d'entrée (alimentation secteur) et de deux câbles de sortie (puissance aux dispositifs de la "cascade" en parallèle). **Equipé avec led smd et ballast électronique incorporé.**

Baliza. Difusor de policarbonato opal. Estructura en fundición a presión de aluminio, poste de aluminio extrudido con detalles fundidos a presión de aluminio, pintura en polvo poliéster con tratamiento de fosfatación. Tornillos de acero inoxidable. Junta de protección de goma. Suministrado con un dispositivo para conectar un cable de entrada (red eléctrica) y dos cables de salida (energía a los dispositivos en "cascada" en paralelo). **Suministrada con led smd y alimentador electrónico incluido.**

Pollerleuchte. Diffusor aus opalem Polycarbonat. Struktur aus Aludruckguss, Ständer aus Aluminium extrusion mit Einzelteilen aus Aludruckguss, Lackierung aus Polyester Pulver mit Phosphatierung. Schrauben aus Edelstahl. Dichtungen aus Polymergummi. Ausgestattet mit einer Vorrichtung zum Anschließen einer Eingangsspannung Kabel (Netz) und zwei Output-Kabel (Stromversorgung von Geräten in "Kaskade" parallel). Ausgestattet mit LED smd. **Eingebautem elektronischem Versorgungsgerät.**



Colore struttura Structure color

Inka 1/60 - 1/62

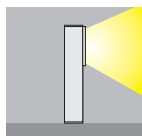
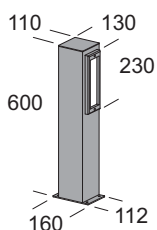

Articolo Item	Colore struttura Structure color			W _{max}	Beam	LUMEN	IP	LUMEN/W	A	
	AT	GR	RU							
<ul style="list-style-type: none"> Led inka 1/60 led-W Led inka 1/60 led-N 	56007	56006	56008	6,3	led	750	IP65	⊕	119	A
	56017	56016	56018	6,3	led	750	IP65	⊕	119	A
<ul style="list-style-type: none"> Led inka 1/62 led-W Led inka 1/62 led-N 	56027	56026	56028	12,6	led	1500	IP65	⊕	119	A
	56037	56036	56038	12,6	led	1500	IP65	⊕	119	A

Inka 1/90 - 1/92

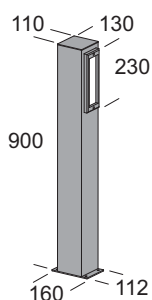

<ul style="list-style-type: none"> Led inka 1/90 led-W Led inka 1/90 led-N 	56047	56046	56048	6,3	led	750	IP65	⊕	119	A
	56057	56056	56058	6,3	led	750	IP65	⊕	119	A
<ul style="list-style-type: none"> Led inka 1/92 led-W Led inka 1/92 led-N 	56067	56066	56068	12,6	led	1500	IP65	⊕	119	A
	56077	56076	56078	12,6	led	1500	IP65	⊕	119	A

Colore struttura Structure color

● Nuova versione New version

AT RAL 7016
Antracite gofrato Embossed anthracite

GR RAL 9006
Grigio gofrato Embossed grey

RU
Ruggine Rust

Led Equipaggiata con led 3000K - Equipped with led 3000K

Led Equipaggiata con led 4000K - Equipped with led 4000K

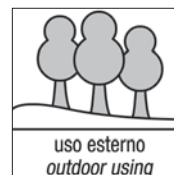
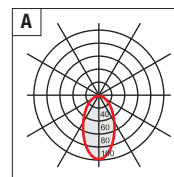
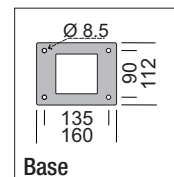



Step

Lampione da giardino. Diffusore in policarbonato opale. Struttura in pressofusione di alluminio, palo in alluminio estruso con particolari in pressofusione di alluminio, verniciatura in polvere poliesteri con trattamento di fosfatazione. Viti in acciaio inox. Guarnizioni in gomma ai polimeri. **Equipaggiata con led smd e alimentatore elettronico incorporato.** Fornito con dispositivo per il collegamento di un cavo di ingresso (alimentazione della rete) e due cavi di uscita (alimentazione degli apparecchi a "cascata" in parallelo).

Bollard. Diffuser made in opal polycarbonate. Structure made in die casting aluminium, pole made in extruded aluminium and die casting aluminium parts with polyester paint and phosphate treatment. Inox steel screws. Gasket made in rubber. **Supplied with smd led and electronic driver included.** Equipped with a device for connecting an input cable (mains supply) and two output cables (power to devices in "cascade" in parallel).

Borne. Diffuseur en polycarbonate opale. Structure réalisée en fonte d'aluminium, pilier réalisé en extrusion d'aluminium avec parties en fonte d'aluminium. Vernis polyester traitement de phosphatation. Vis en acier inox. Joint en gomme. **Equipée avec led smd et ballast électronique incorporé.** Equipé d'un dispositif permettant de connecter un câble d'entrée (alimentation secteur) et de deux câbles de sortie (puissance aux dispositifs de la "cascade" en parallèle).

Baliza. Difusor de policarbonato opal. Estructura en fundición a presión de aluminio, poste de aluminio extrudido con detalles fundidos a presión de aluminio, pintura en polvo poliéster con tratamiento de fosfatación. Tornillos de acero inoxidable. Junta de protección de goma. **Suministrada con led smd y alimentador electrónico incluido.** Suministrado con un dispositivo para conectar un cable de entrada (red eléctrica) y dos cables de salida (energía a los dispositivos en "cascada" en paralelo).

Pollerleuchte. Diffusor aus opalem Polycarbonat. Struktur aus Aludruckguss, Ständer aus Aluminium extrusion mit Einzelteilen aus Aludruckguss, Lackierung aus Polyester Pulver mit Phosphatierung. Schrauben aus Edelstahl. Dichtungen aus Polymergummi. **Ausgestattet mit LED smd. Eingebautem elektronischem Versorgungsgerät.** Ausgestattet mit einer Vorrichtung zum Anschließen einer Eingangsspannung Kabel (Netz) und zwei Output-Kabel (Stromversorgung von Geräten in "Kaskade" parallel).

Step 1/30

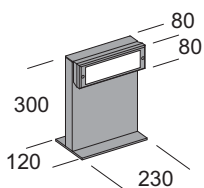

Articolo <i>Item</i>	Colore struttura <i>Structure color</i>			W _{max}	LUMEN	LUMEN/W	A
	AT	GR	RU				
● Led step 1/30 led-W	57637	57636	57638	6,3	750	IP65	⊕ 119 A
● Led step 1/30 led-N	57647	57646	57648	6,3	750	IP65	⊕ 119 A

Step 1/60

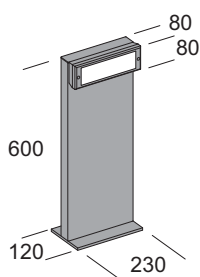

● Led step 1/60 led-W	57657	57656	57658	6,3	750	IP65	⊕ 119 A
● Led step 1/60 led-N	57667	57666	57668	6,3	750	IP65	⊕ 119 A

Step 1/32

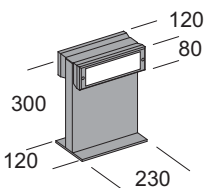

● Led step 1/32 led-W	57677	57676	57678	12,6	1500	IP65	⊕ 119 A
● Led step 1/32 led-N	57687	57686	57688	12,6	1500	IP65	⊕ 119 A

Step 1/62

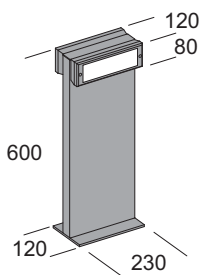

● Led step 1/62 led-W	57697	57696	57698	12,6	1500	IP65	⊕ 119 A
● Led step 1/62 led-N	57707	57706	57708	12,6	1500	IP65	⊕ 119 A

Colore struttura *Structure color*

- AT** RAL 7016 Antracite gofrato *Embossed anthracite*
- GR** RAL 9006 Grigio gofrato *Embossed grey*
- **RU** Ruggine *Rust*

● Nuova versione *New version*

- Led** Equipaggiata con led 3000K - *Equipped with led 3000K*
- Led** Equipaggiata con led 4000K - *Equipped with led 4000K*

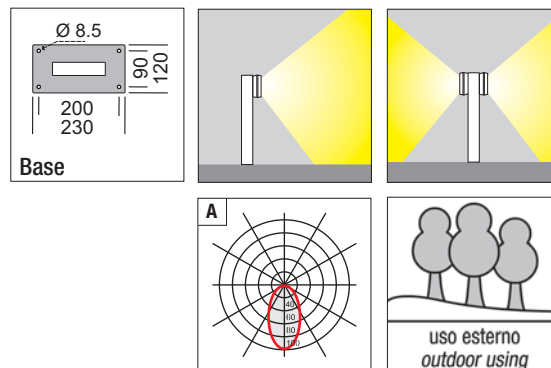

Colore struttura Structure color

Articolo Item

AT

GR

RU

W_{max}

LUMEN



LUMEN/W



Codice Code

Step 2/30

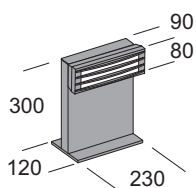

• Led	step 2/30 led-W	57717	57716	57718	6,3	led	750	IP65	⊕	119	A
• Led	step 2/30 led-N	57727	57726	57728	6,3	led	750	IP65	⊕	119	A

Step 2/60

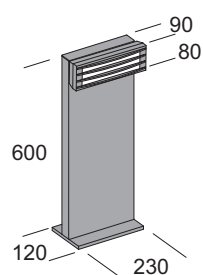

• Led	step 2/60 led-W	57737	57736	57738	6,3	led	750	IP65	⊕	119	A
• Led	step 2/60 led-N	57747	57746	57748	6,3	led	750	IP65	⊕	119	A

Step 2/32

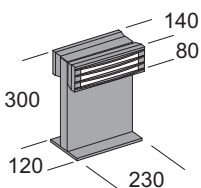

• Led	step 2/32 led-W	57757	57756	57758	12,6	led	1500	IP65	⊕	119	A
• Led	step 2/32 led-N	57767	57766	57768	12,6	led	1500	IP65	⊕	119	A

Step 2/62

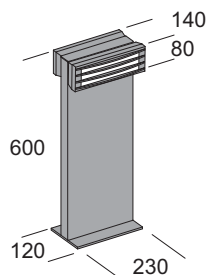

• Led	step 2/62 led-W	57777	57776	57778	12,6	led	1500	IP65	⊕	119	A
• Led	step 2/62 led-N	57787	57786	57788	12,6	led	1500	IP65	⊕	119	A

Colore struttura Structure color

• Nuova versione New version

AT RAL 7016

Antracite gofrato Embossed anthracite

GR RAL 9006

Grigio gofrato Embossed grey

• RU

Ruggine Rust

Led Equipaggiata con led 3000K - Equipped with led 3000K

Led Equipaggiata con led 4000K - Equipped with led 4000K

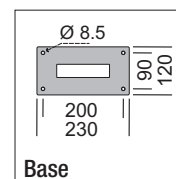

Base

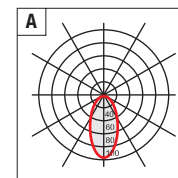
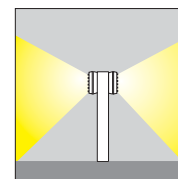
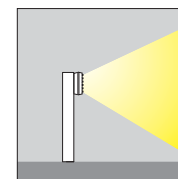

A



Colore struttura Structure color

Step 3/30

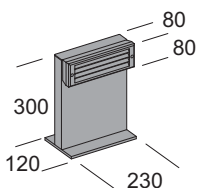

Articolo Item	Colore struttura Structure color			W _{max}	led	LUMEN	IP	LUMEN/W	A
	AT	GR	RU						
● Led step 3/30 led-W	57797	57796	57798	6,3	led	750	IP65	119	A
● Led step 3/30 led-N	57807	57806	57808	6,3	led	750	IP65	119	A

Step 3/60

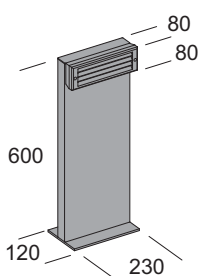

● Led step 3/60 led-W	57817	57816	57818	6,3	led	750	IP65	119	A
● Led step 3/60 led-N	57827	57826	57828	6,3	led	750	IP65	119	A

Step 3/32

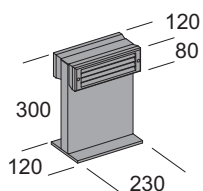

● Led step 3/32 led-W	57837	57836	57838	12,6	led	1500	IP65	119	A
● Led step 3/32 led-N	57847	57846	57848	12,6	led	1500	IP65	119	A

Step 3/62

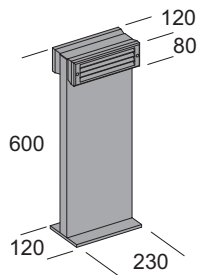

● Led step 3/62 led-W	57857	57856	57858	12,6	led	1500	IP65	119	A
● Led step 3/62 led-N	57867	57866	57868	12,6	led	1500	IP65	119	A

Colore struttura Structure color

- AT** RAL 7016
Antracite gofrato Embossed anthracite
- GR** RAL 9006
Grigio gofrato Embossed grey
- **RU**
Ruggine Rust

● Nuova versione New version

- Led** Equipaggiata con led 3000K - Equipped with led 3000K
- Led** Equipaggiata con led 4000K - Equipped with led 4000K

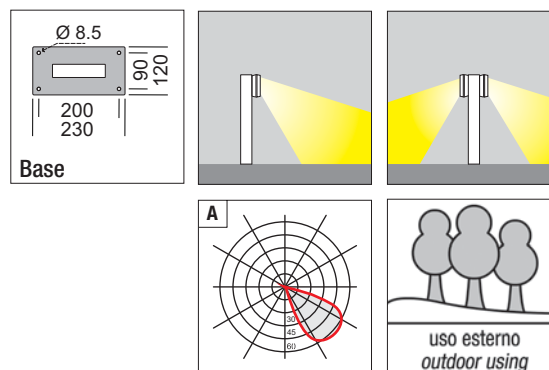



Kit

Lampione da giardino. Diffusore in policarbonato colore anice con rigatura prismatica interna. Parabola in metallo verniciato bianco. Struttura e palo in alluminio estruso con particolari in pressofusione di alluminio, verniciatura in polvere poliesteri con trattamento di fosfatazione. Viti in acciaio inox. Guarnizioni in silicone. Fornito con dispositivo per il collegamento di un cavo di ingresso (alimentazione della rete) e due cavi di uscita (alimentazione degli apparecchi a "cascata" in parallelo). **Versione LED equipaggiata con led smd e alimentatore elettronico incorporato.**

Bollard. Diffuser made in polycarbonate colour anise with prismatic ruling inside. Inside reflector made in white painted metal. Structure and pole made in extruded aluminium and die casting aluminium parts with polyester paint and phosphate treatment. Inox steel screws. Gaskets made in silicone rubber. Equipped with a device for connecting an input cable (mains supply) and two output cables (power to devices in "cascade" in parallel). **LED version equipped with smd led and electronic driver included.**

Borne. Diffuseur en polycarbonate couleur anis avec réglage prismatique intérieure. Réflecteur intérieur en métal verni blanc. Structure et pilier réalisés en extrusion d'aluminium avec parties en fonte d'aluminium. Vernis polyester traitement de phosphatation. Vis en acier inox. Joint en gomme de silicone. Equipé d'un dispositif permettant de connecter un câble d'entrée (alimentation secteur) et de deux câbles de sortie (puissance aux dispositifs de la "cascade" en parallèle). **Version LED équipée avec led smd et ballast électronique incorporé.**

Baliza. Difusor de policarbonato color anís con estriado prismático interno. Parábola reflectante de metal pintado blanco. Estructura y poste de aluminio extrudido con detalles fundidos a presión de aluminio, pintura en polvo poliéster con tratamiento de fosfatación. Tornillos de acero inoxidable. Junta de protección de silicona. Suministrado con un dispositivo para conectar un cable de entrada (red eléctrica) y dos cables de salida (energía a los dispositivos en "cascada" en paralelo). **Version LED suministrada con led smd y alimentador electrónico incluido.**

Pollerleuchte. Diffusor aus anisfarbenem Polycarbonat innen prismatisch. Parabolspiegel aus weiß lackiertem Metall. Struktur und Ständer aus Aluminium extrusion mit Einzelteilen aus Aludruckguss, Lackierung aus Polyester Pulver mit Phosphatierung. Schrauben aus rostfreiem Stahl. Silikondichtungen. Ausgestattet mit einer Vorrichtung zum Anschließen einer Eingangsspannung Kabel (Netz) und zwei Output-Kabel (Stromversorgung von Geräten in "Kaskade" parallel). **Ausführung LED zum led smd und integriert Versorgungsgerät elektronisch.**



Colore struttura Structure color

Articolo Item

AT

GR

RU

W_{max}

LUMEN



LUMEN/W



Codice Code

Kit 1/60

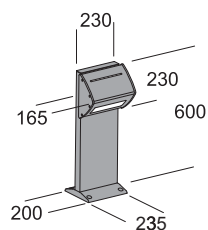

E27	kit 1/60	65257	65256	65258	1x57	E27	915	IP65		16	A
	kit 1/60 led-W	59007	59006	59008	12,6	led	950	IP65		75	A
	kit 1/60 led-N	59017	59016	59018	12,6	led	950	IP65		75	A
EL	kit 1/60 EL	66927	66926	66928	1x26	GX24q-3	1800	IP65		69	A

Kit 1/100

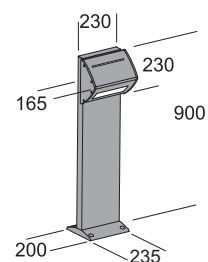

E27	kit 1/100	65267	65266	65268	1x57	E27	915	IP65		16	A
	kit 1/100 led-W	59027	59026	59028	12,6	led	950	IP65		75	A
	kit 1/100 led-N	59037	59036	59038	12,6	led	950	IP65		75	A
EL	kit 1/100 EL	66947	66946	66948	1x26	GX24q-3	1800	IP65		69	A

Kit 1/62

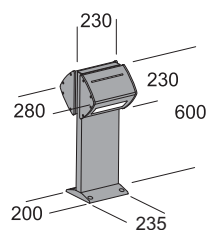

E27	kit 1/62	65277	65276	65278	2x57	E27	1830	IP65		16	A
	kit 1/62 led-W	59047	59046	59048	25,2	led	1900	IP65		75	A
	kit 1/62 led-N	59057	59056	59058	25,2	led	1900	IP65		75	A
EL	kit 1/62 EL	66967	66966	66968	2x26	GX24q-3	3600	IP65		69	A

Kit 1/102

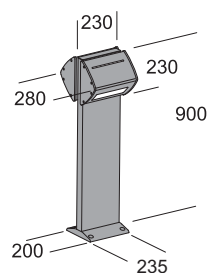

E27	kit 1/102	65287	65286	65288	2x57	E27	1830	IP65		16	A
	kit 1/102 led-W	59067	59066	59068	25,2	led	1900	IP65		75	A
	kit 1/102 led-N	59077	59076	59078	25,2	led	1900	IP65		75	A
EL	kit 1/102 EL	66987	66986	66988	2x26	GX24q-3	3600	IP65		69	A

Colore struttura Structure color

● Nuova versione New version

AT RAL 7016

Antracite goffrato Embossed anthracite

GR RAL 9006

Grigio goffrato Embossed grey

● RU

Ruggine Rust

Equipaggiata con led 3000K - Equipped with led 3000K

Equipaggiata con led 4000K - Equipped with led 4000K

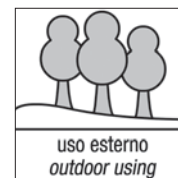
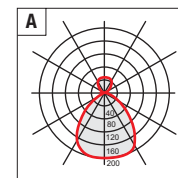
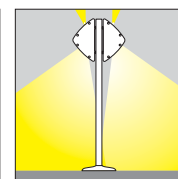
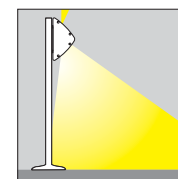
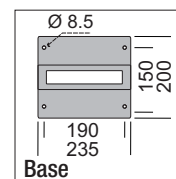

Kit 2/60

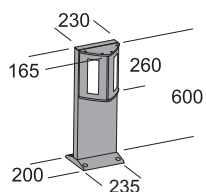

Articolo Item	Colore struttura Structure color			W _{max}	E	LUMEN	IP	LUMEN/W	A	
	AT	GR	RU							
E27 kit 2/60	65297	65296	65298	1x57	E27	915	IP65	⊕	16	A
● Led kit 2/60 led-W	59087	59086	59088	12,6	led	1500	IP65	⊕	119	A
● Led kit 2/60 led-N	59097	59096	59098	12,6	led	1500	IP65	⊕	119	A
EL kit 2/60 EL	67007	67006	67008	1x26	GX24q-3	1800	IP65	⊕	69	A

Kit 2/100

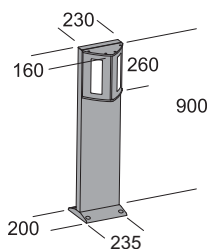

E27 kit 2/100	65307	65306	65308	1x57	E27	915	IP65	⊕	16	A
● Led kit 2/100 led-W	59107	59106	59108	12,6	led	1500	IP65	⊕	119	A
● Led kit 2/100 led-N	59117	59116	59118	12,6	led	1500	IP65	⊕	119	A
EL kit 2/100 EL	67027	67026	67028	1x26	GX24q-3	1800	IP65	⊕	69	A

Kit 2/62

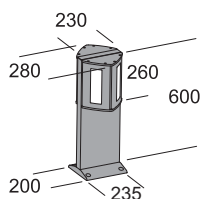

E27 kit 2/62	65317	65316	65318	2x57	E27	1830	IP65	⊕	16	A
● Led kit 2/62 led-W	59127	59126	59128	25,2	led	3000	IP65	⊕	119	A
● Led kit 2/62 led-N	59137	59136	59138	25,2	led	3000	IP65	⊕	119	A
EL kit 2/62 EL	67047	67046	67048	2x26	GX24q-3	3600	IP65	⊕	69	A

Kit 2/102

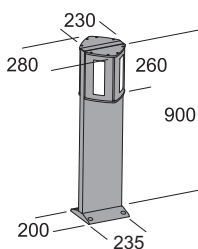

E27 kit 2/102	65327	65326	65328	2x57	E27	1830	IP65	⊕	16	A
● Led kit 2/102 led-W	59147	59146	59148	25,2	led	3000	IP65	⊕	119	A
● Led kit 2/102 led-N	59157	59156	59158	25,2	led	3000	IP65	⊕	119	A
EL kit 2/102 EL	67067	67066	67068	2x26	GX24q-3	3600	IP65	⊕	69	A

Colore struttura Structure color

- AT RAL 7016**
 Antracite gofrato Embossed anthracite
- GR RAL 9006**
 Grigio gofrato Embossed grey
- RU**
 Ruggine Rust

● Nuova versione New version

- Led Equipaggiata con led 3000K - Equipped with led 3000K
- Led Equipaggiata con led 4000K - Equipped with led 4000K

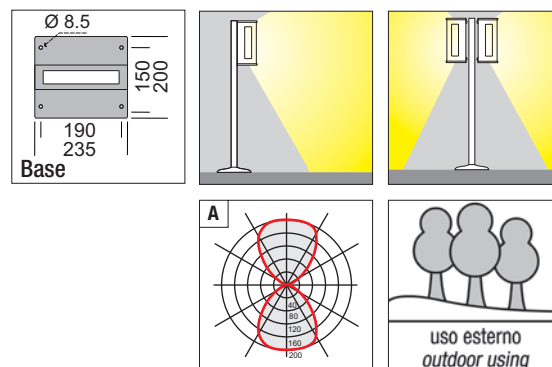

Nano

Lampione da giardino. Diffusore in policarbonato trasparente, con pellicola di policarbonato opale inserita internamente. Struttura in alluminio estruso con particolari in policarbonato, verniciatura in polvere poliestere con trattamento di fosfatazione. Viti in acciaio inox. Guarnizioni in silicone. Riflettore interno in alluminio per luce indiretta. Predisposta per il collegamento di un cavo di ingresso (alimentazione della rete) e un cavo di uscita (alimentazione degli apparecchi a "cascata" in parallelo). **Equipaggiata con led smd e alimentatore elettronico incorporato.**

Bollard. Diffuser made in transparent polycarbonate with inside opal polycarbonate film. Structure made in extruded aluminium and polycarbonate parts with polyester paint and phosphate treatment. Inox steel screws. Gasket made in silicon rubber. Aluminium inside reflector for indirect light. Ready to connect an input cable (mains supply) and an output cable (power to devices in "cascade" in parallel). **Equipped with smd led and electronic driver included.**

Borne. Diffuseur en polycarbonate transparente avec un film de polycarbonate opale à l'intérieur. Structure réalisée en extrusion d'aluminium avec parties en polycarbonate. Vernis polyester traitement de phosphatation. Vis en acier inox. Joint en gomme de silicone. Réflecteur intérieur en aluminium pour éclairage indirecte. Prêt pour la connexion d'un câble d'entrée (alimentation secteur) et un câbles de sortie (puissance aux dispositifs de la "cascade" en parallèle). **Equipée avec led smd et ballast électronique incorporé.**

Baliza. Difusor de policarbonato transparente, con una película interna de policarbonato opale. Estructura de aluminio extrudido con detalles de policarbonato, pintura en polvo poliéster con tratamiento de fosfatación. Tornillos de acero inoxidable. Junta de protección de silicona. Reflector interno en aluminio para iluminación indirecta. Listo para la conexión de un cable de entrada (red eléctrica) y un cable de salida (energía a los dispositivos en "cascada" en paralelo). **Suministrada con led smd y alimentador electrónico incluido.**

Pollerleuchte. Diffusor aus transparentem Polycarbonat mit eine innen Opal Polycarbonatfilm. Struktur aus Aluminium extrusion mit Einzelteilen aus Polycarbonat, Lackierung aus Polyester Pulver mit Phosphatierung. Schrauben aus Edelstahl. Silikondichtungen. Reflektor aus Aluminium für indirektem licht. Ausgestattet zum Anschließen einer Kabelnetz (Eingangsspannung) und einer Output-Kabel (Stromversorgung von Geräten in "Kaskade" parallel). **Ausgestattet mit LED smd. Eingebautem elektronischem Versorgungsgerät.**



Nano 12

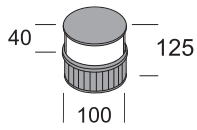

Colore struttura Structure color

Articolo Item

AT GR RU
Codice Code

W_{max}



LUMEN



LUMEN/W



● Led	nano 12 led-W	59167	59166	59168	5,6	led	640	IP65	⊕	114	A
● Led	nano 12 led-N	59177	59176	59178	5,6	led	640	IP65	⊕	114	A

Nano 35

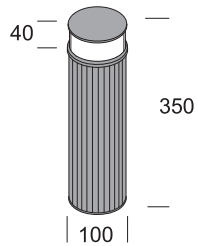

● Led	nano 35 led-W	59187	59186	59188	5,6	led	640	IP65	⊕	114	A
● Led	nano 35 led-N	59197	59196	59198	5,6	led	640	IP65	⊕	114	A



Colore struttura Structure color

● Nuova versione New version

AT	RAL 7016 Antracite gofrato Embossed anthracite	GR	RAL 9006 Grigio gofrato Embossed grey	● RU	Ruggine Rust
----	--	----	---	------	---------------------

- Led Equipaggiata con led 3000K - Equipped with led 3000K
- Led Equipaggiata con led 4000K - Equipped with led 4000K

senza ombre shadowless

120°
Ø80
Ø6,5
Ø100
Base

A

uso esterno
outdoor using



Isy

Lampione da giardino. Diffusore in policarbonato trasparente. Struttura in alluminio estruso con particolari in policarbonato, verniciatura in polvere poliestere con trattamento di fosfatazione. Viti in acciaio inox. Guarnizioni in silicone. Diffusore interno in policarbonato satinato per una luce diffusa a 360°. Fornito con dispositivo per il collegamento di un cavo di ingresso (alimentazione della rete) e due cavi di uscita (alimentazione degli apparecchi a "cascata" in parallelo).

Bollard. Diffuser made in transparent polycarbonate. Structure made in extruded aluminium and polycarbonate parts with polyester paint and phosphate treatment. Inox steel screws. Gasket made in silicon rubber. Inside diffuser made of polycarbonate anise color for 360° diffused light. Equipped with base and anchor bolts to be cemented and a device for connecting an input cable (mains supply) and two output cables (power to devices in "cascade" in parallel).

Borne. Diffuseur en polycarbonate transparent. Structure réalisée en extrusion d'aluminium avec parties en polycarbonate. Vernis polyester traitement de phosphatation. Vis en acier inox. Joint en gomme de silicone. Diffuseur intérieur en polycarbonate couleur anise pour éclairage diffuse à 360°. Equipé avec dispositif permettant de connecter un câble d'entrée (alimentation secteur) et de deux câbles de sortie (puissance aux dispositifs de la "cascade" en parallèle).

Baliza. Difusor de policarbonato transparente. Estructura de aluminio extrudido con detalles de policarbonato, pintura en polvo poliéster con tratamiento de fosfatación. Tornillos de acero inoxidable. Junta de protección de silicona. Difusor interno de policarbonato anís para iluminación con luz difusa a 360°. Suministrado con un dispositivo para conectar un cable de entrada (red eléctrica) y dos cables de salida (energía a los dispositivos en "cascada" en paralelo).

Pollerleuchte. Diffusor aus transparentem Polycarbonat. Struktur aus Aluminium extrusion mit Einzelteilen aus Polycarbonat, Lackierung aus Polyester Pulver mit Phosphatierung. Schrauben aus Edelstahl. Silikondichtungen. Interner diffusor aus satiniertem Polycarbonat für diffuses Licht 360°. Ausgestattet mit einer Vorrichtung zum Anschließen einer Eingangsspannung Kabel (Netz) und zwei Output-Kabel (Stromversorgung von Geräten in "Kaskade" parallel).

Colore struttura Structure color

Isy 50

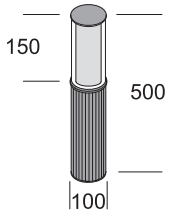

Articolo Item	AT	GR	RU	W _{max}		LUMEN		LUMEN/W	
	Codice Code								
<input type="checkbox"/> EL isy 50 EL	68357	68356	68358	1x26	G24q-3	1800	IP65	69	A

Isy 70

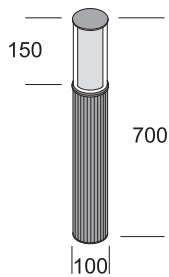

<input type="checkbox"/> EL isy 70 EL	68387	68386	68388	1x26	G24q-3	1800	IP65	69	A
---------------------------------------	-------	-------	-------	------	--------	------	------	----	---

Isy 85

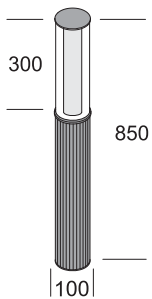

<input checked="" type="checkbox"/> EL isy 85 EL	68107	68106	68108	1x24	2G11	1800	IP65	75	A
--	-------	-------	-------	------	------	------	------	----	---

Colore struttura Structure color

● Nuova versione New version

- AT RAL 7016**
Antracite gofrato Embossed anthracite
- GR RAL 9006**
Grigio gofrato Embossed grey
- RU**
Ruggine Rust

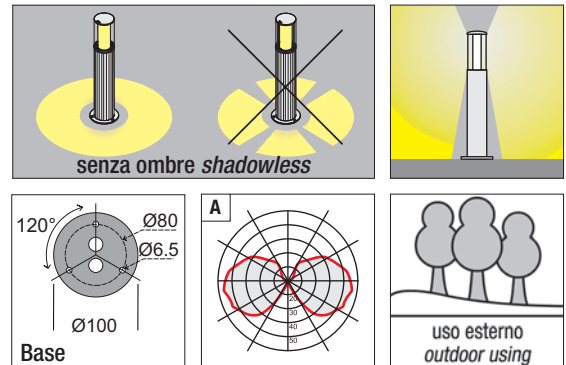



Grill

Lampione da giardino. Diffusore in policarbonato trasparente. Struttura in alluminio estruso con particolari in policarbonato, verniciatura in polvere poliesteri con trattamento di fosfatazione. Viti in acciaio inox. Guarnizioni in silicone. Frangiluce lamellare in alluminio per luce direzionata. Fornito con dispositivo per il collegamento di un cavo di ingresso (alimentazione della rete) e due cavi di uscita (alimentazione degli apparecchi a "cascata" in parallelo).

Bollard. Diffuser made in transparent polycarbonate. Structure made in extruded aluminium and polycarbonate parts with polyester paint and phosphate treatment. Inox steel screws. Gasket made in silicon rubber. Louvre reflector made in aluminium for directional light. Equipped with base and anchor bolts to be cemented and a device for connecting an input cable (mains supply) and two output cables (power to devices in "cascade" in parallel).

Borne. Diffuseur en polycarbonate transparent. Structure réalisée en extrusion d'aluminium avec parties en polycarbonate. Vernis polyester traitement de phosphatation. Vis en acier inox. Joint en gomme de silicone. Réflecteur à lamelles en aluminium pour éclairage directionnelle. Equipé avec dispositif permettant de connecter un câble d'entrée (alimentation secteur) et de deux câbles de sortie (puissance aux dispositifs de la "cascade" en parallèle).

Baliza. Difusor de policarbonato transparente. Estructura de aluminio extrudido con detalles de policarbonato, pintura en polvo poliéster con tratamiento de fosfatación. Tornillos de acero inoxidable. Junta de protección de silicona. Reflector laminar en aluminio para iluminación direccional. Suministrado con un dispositivo para conectar un cable de entrada (red eléctrica) y dos cables de salida (energía a los dispositivos en "cascada" en paralelo).

Pollerleuchte. Diffusor aus transparentem Polycarbonat. Struktur aus Aluminium extrusion mit Einzelteilen aus Polycarbonat, Lackierung aus Polyester Pulver mit Phosphatierung. Schrauben aus Edelstahl. Silikondichtungen. Lamellenreflektor aus Aluminium für gerichtetes Licht. Ausgestattet mit einer Vorrichtung zum Anschließen einer Eingangsspannung Kabel (Netz) und zwei Output-Kabel (Stromversorgung von Geräten in "Kaskade" parallel).

Colore struttura Structure color

Grill 50

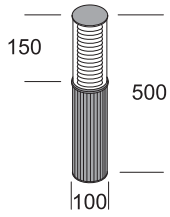

Articolo Item	AT	GR	RU	W _{max}	LUMEN	LUMEN/W	IP	⊕	A	
Codice Code										
EL grill 50 EL	68367	68366	68368	1x26	G24q-3	1800	IP65	⊕	69	A

Grill 70

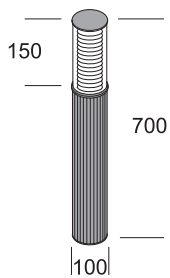

EL grill 70 EL	68397	68396	68398	1x26	G24q-3	1800	IP65	⊕	69	A
----------------	-------	-------	-------	------	--------	------	------	---	----	---

Grill 85

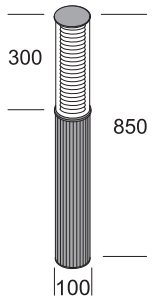

● EL grill 85 EL	68067	68066	68068	1x24	2G11	1800	IP65	⊕	75	A
------------------	-------	-------	-------	------	------	------	------	---	----	---

Colore struttura Structure color

AT RAL 7016
Antracite gofrato Embossed anthracite

GR RAL 9006
Grigio gofrato Embossed grey

● **RU**
Ruggine Rust

● Nuova versione New version

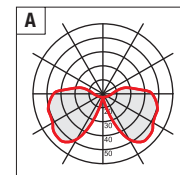
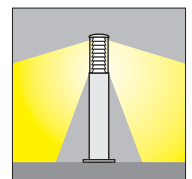
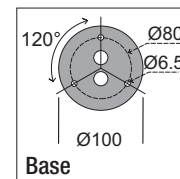

Faro

Lampione da giardino. Diffusore in policarbonato trasparente. Struttura in alluminio estruso con particolari in policarbonato, verniciatura in polvere poliestere con trattamento di fosfatazione. Viti in acciaio inox. Guarnizioni in silicone. Diffusore interno in policarbonato satinato con parabola regolabile in alluminio per orientare il fascio luminoso. Fornito con dispositivo per il collegamento di un cavo di ingresso (alimentazione della rete) e due cavi di uscita (alimentazione degli apparecchi a "cascata" in parallelo). **Versione LED equipaggiata con led smd e alimentatore elettronico incorporato.**

Bollard. Diffuser made in transparent polycarbonate. Structure made in extruded aluminium and polycarbonate parts with polyester paint and phosphate treatment. Inox steel screws. Gasket made in silicon rubber. Inside diffuser made of polycarbonate color anise complete with adjustable aluminum reflector to direct light beam. Equipped with base and anchor bolts to be cemented and a device for connecting an input cable (mains supply) and two output cables (power to devices in "cascade" in parallel). **LED version equipped with smd led and electronic driver included.**

Borne. Diffuseur en polycarbonate transparent. Structure réalisée en extrusion d'aluminium avec parties en polycarbonate. Vernis polyester traitement de phosphatation. Vis en acier inox. Joint en gomme de silicone. Diffusor intérieur en polycarbonate couleur anise avec réflecteur réglable en aluminium pour diriger la lumière. Equipé avec dispositif permettant de connecter un câble d'entrée (alimentation secteur) et de deux câbles de sortie (puissance aux dispositifs de la "cascade" en parallèle). **Version LED équipée avec led smd et ballast électronique incorporé.**

Baliza. Difusor de policarbonato transparente. Estructura de aluminio extrudido con detalles de policarbonato, pintura en polvo poliéster con tratamiento de fosfatación. Tornillos de acero inoxidable. Junta de protección de silicona. Difusor interno de policarbonato anís con reflector regable de aluminio para dirigir el rayo de luz. Suministrado con un dispositivo para conectar un cable de entrada (red eléctrica) y dos cables de salida (energía a los dispositivos en "cascada" en paralelo). **Version LED suministrada con led smd y alimentador electrónico incluido.**

Pollerleuchte. Diffusor aus transparentem Polycarbonat. Struktur aus Aluminium extrusion mit Einzelteilen aus Polycarbonat, Lackierung aus Polyester Pulver mit Phosphatierung. Schrauben aus Edelstahl. Silikondichtungen. Interner diffusor aus satiniertem Polycarbonat mit Schwenkbarem Reflektor aus Aluminium für Lenken der Lichtstrahl. Ausgestattet mit einer Vorrichtung zum Anschließen einer Eingangsspannung Kabel (Netz) und zwei Output-Kabel (Stromversorgung von Geräten in "Kaskade" parallel). **Ausführung LED zum led smd und integriert Versorgungsgerät elektronisch.**

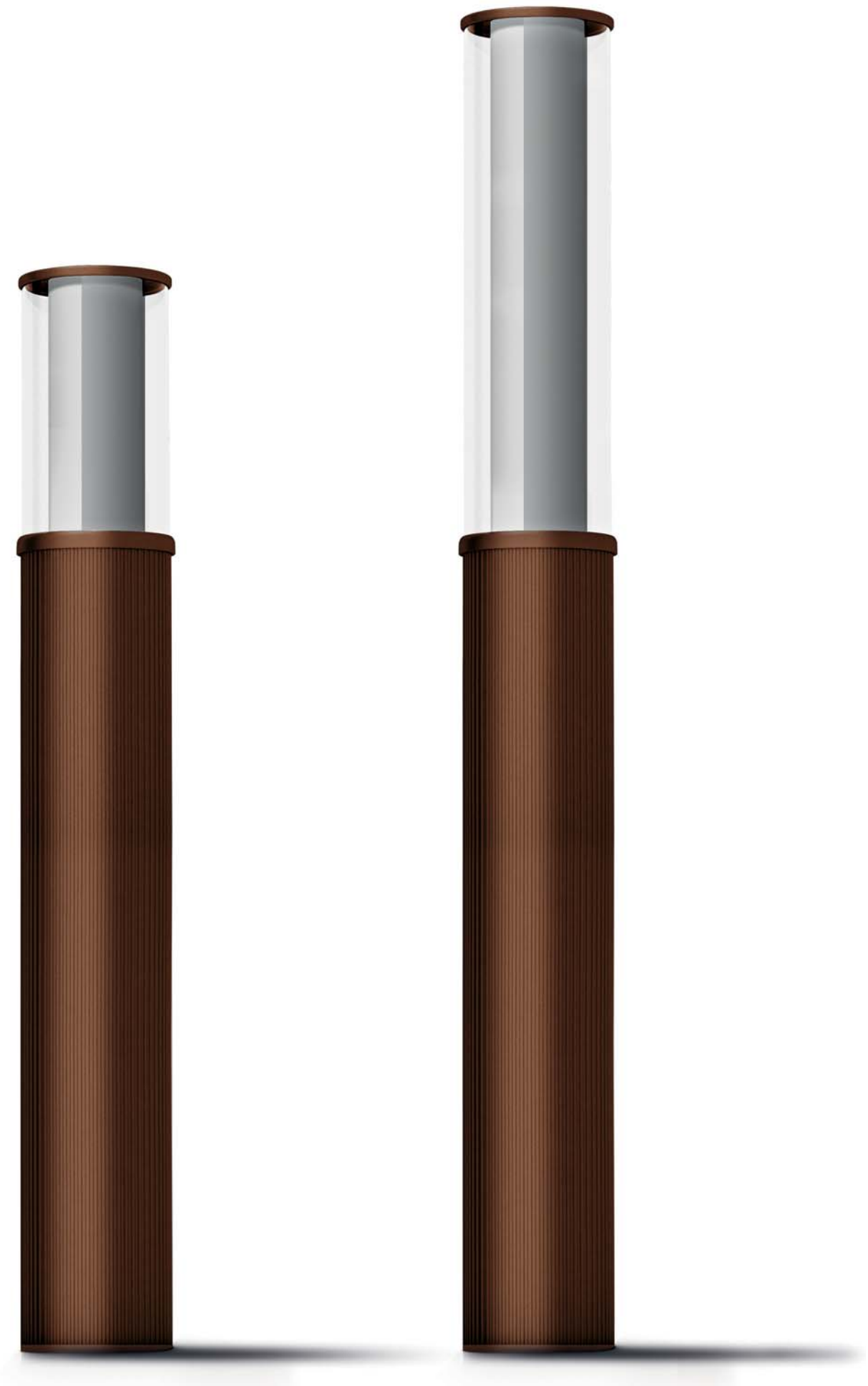

Colore struttura Structure color

Faro 50

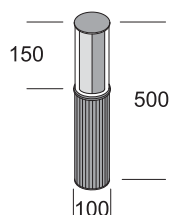

Articolo Item	Colore struttura Structure color			W _{max}		LUMEN			LUMEN/W	
	AT	GR	RU							
● Led faro 50 led-W	57877	57876	57878	6,2	led	850	IP65	⊕	137	B
● Led faro 50 led-N	57887	57886	57888	6,2	led	850	IP65	⊕	137	B
EL faro 50 EL	68347	68346	68348	1x26	G24q-3	1800	IP65	⊕	69	A

Faro 70

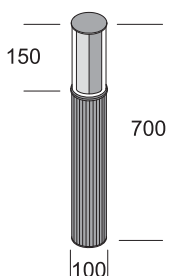

● Led faro 70 led-W	57897	57896	57898	6,2	led	850	IP65	⊕	137	B
● Led faro 70 led-N	57907	57906	57908	6,2	led	850	IP65	⊕	137	B
EL faro 70 EL	68377	68376	68378	1x26	G24q-3	1800	IP65	⊕	69	A

Faro 85

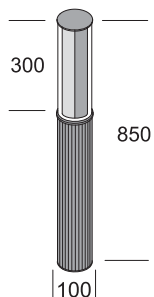

● Led faro 85 led-W	57917	57916	57918	11,5	led	1560	IP65	⊕	136	B
● Led faro 85 led-N	57927	57926	57928	11,5	led	1560	IP65	⊕	136	B
EL faro 85 EL	68087	68086	68088	1x24	2G11	1800	IP65	⊕	75	A

Colore struttura Structure color

● Nuova versione New version

AT RAL 7016 Antracite gofrato Embossed anthracite	GR RAL 9006 Grigio gofrato Embossed grey	● RU Ruggine Rust
---	--	-----------------------------

Led Equipaggiata con led 3000K - Equipped with led 3000K

Led Equipaggiata con led 4000K - Equipped with led 4000K

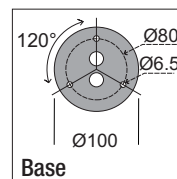

Base

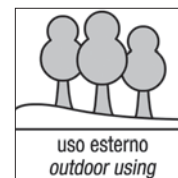
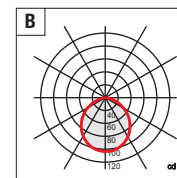
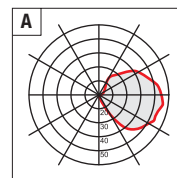
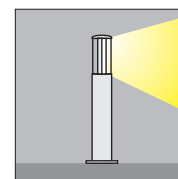
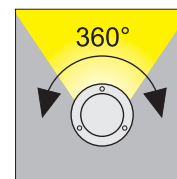



Orientamento del fascio luminoso

Orientation of light beam

Orientation du faisceau lumineux

Orientacion del haz luminoso

Ausrichtung des Lichtbündels

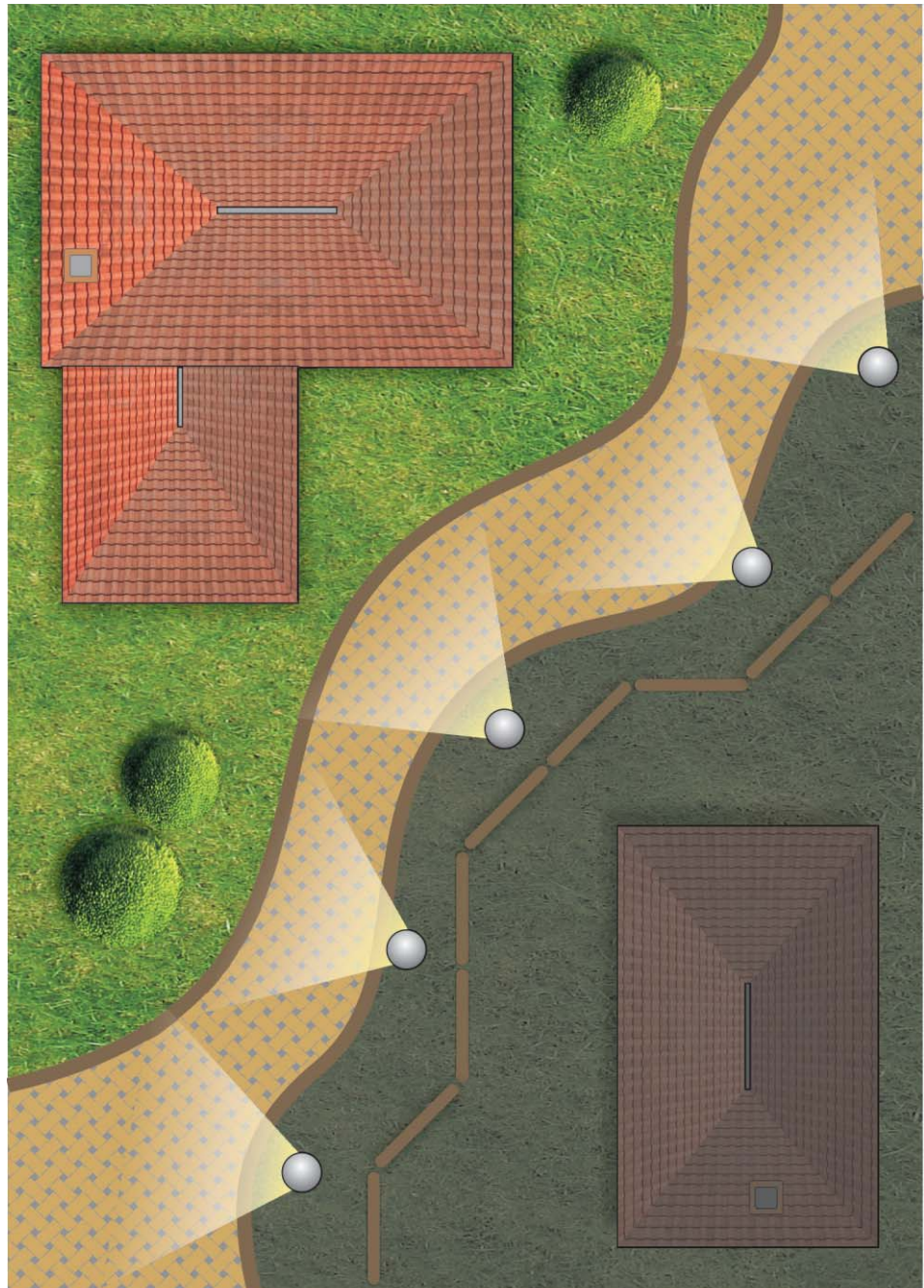
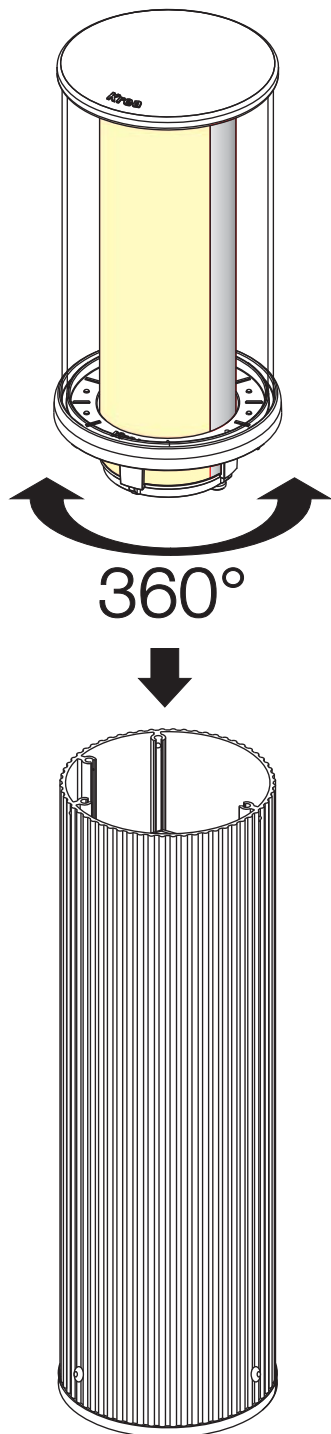

Best

Lampione da giardino. Diffusore in policarbonato trasparente. Struttura in alluminio estruso con particolari in pressofusione di alluminio, verniciatura in polvere poliestere con trattamento di fosfatazione. Viti in acciaio inox. Guarnizioni in silicone. Diffusore interno in vetro pirex satinato per una luce diffusa a 360°. Fornito con dispositivo per il collegamento di un cavo di ingresso (alimentazione della rete) e due cavi di uscita (alimentazione degli apparecchi a "cascata" in parallelo). **Versione LED equipaggiata con led smd e alimentatore elettronico incorporato.** Base tirafondi, da interrare nel cemento, acquistabile separatamente.

Bollard. Diffuser made in transparent polycarbonate. Structure made in extruded aluminium and die casting aluminium parts with polyester paint and phosphate treatment. Inox steel screws. Gasket made in silicon rubber. Inside diffuser made of sandblasted Pirex glass for 360° diffused light. Equipped with a device for connecting an input cable (mains supply) and two output cables (power to devices in "cascade" in parallel). **LED version equipped with smd led and electronic driver included.** Base with anchor bolts, to be cemented, purchasable separately.

Borne. Diffuseur en polycarbonate transparent. Structure réalisée en extrusion d'aluminium avec parties en fonte d'aluminium. Vernis polyester traitement de phosphatation. Vis en acier inox. Joint en gomme de silicone. Diffuseur intérieur en verre Pirex sablé pour éclairage diffuse à 360°. Equipé avec dispositif permettant de connecter un câble d'entrée (alimentation secteur) et de deux câbles de sortie (puissance aux dispositifs de la "cascade" en parallèle). **Version LED équipée avec led smd et ballast électronique incorporé.** Base avec boulons d'ancrage, de enterrer dans le béton, vendu séparément.

Baliza. Difusor de policarbonato transparente. Estructura de aluminio extrudido con detalles fundidos a presión de aluminio, pintura en polvo poliéster con tratamiento de fosfatación. Tornillos de acero inoxidable. Junta de protección de silicona. Difusor interno de vidrio Pirex arenado internamente para iluminación con luz difusa a 360°. Suministrado con un dispositivo para conectar un cable de entrada (red eléctrica) y dos cables de salida (energía a los dispositivos en "cascada" en paralelo). **Version LED suministrada con led smd y alimentador electrónico incluido.** Base con pernos de anclaje, para enterrar nel suelo, que se vende separado.

Pollerleuchte. Diffusor aus transparentem Polycarbonat. Struktur aus Aluminium extrusion mit Einzelteilen aus Aludruckguss, Lackierung aus Polyester Pulver mit Phosphatierung. Schrauben aus Edelstahl. Silikondichtungen. Interner diffusor aus satiniertem Pyrexglas für diffuses Licht 360°. Ausgestattet mit einer Vorrichtung zum Anschließen einer Eingangsspannung Kabel (Netz) und zwei Output-Kabel (Stromversorgung von Geräten in "Kaskade" parallel). **Ausführung LED zum led smd und integriert Versorgungsgerät elektronisch.** Sockel mit Ankerbolzen, in Zement begraben werden, separat erhältlich.



Best 50

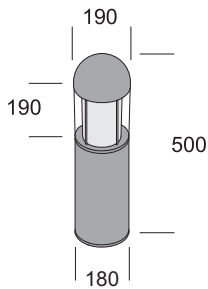

Articolo Item	Colore struttura Structure color			W _{max}	E27	LUMEN	IP54	⊕	LUMEN/W	A
	AT	GR	RU							
E27 best 50	65347	65346	65348	1x57	E27	915	IP54	⊕	16	A
● Led best 50 led-W	57937	57936	57938	21	led	2400	IP54	⊕	114	A
● Led best 50 led-N	57947	57946	57948	21	led	2400	IP54	⊕	114	A
EL best 50 EL	68047	68046	68048	1x42(a)	GX24q-4	3200	IP54	⊕	76	A
● MDEL best 50/35 MD-EL	67107	67106	67108	1x35	E27	3800	IP54	⊕	109	A
● best 50/70 MD-EL	67117	67116	67118	1x70	E27	7200	IP54	⊕	103	A

Best 90

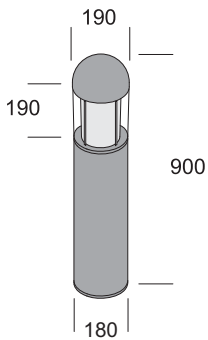

E27 best 90	65367	65366	65368	1x57	E27	915	IP54	⊕	16	A
● Led best 90 led-W	57957	57956	57958	21	led	2400	IP54	⊕	114	A
● Led best 90 led-N	57967	57966	57968	21	led	2400	IP54	⊕	114	A
EL best 90 EL	68917	68916	68918	1x42(a)	GX24q-4	3200	IP54	⊕	76	A
● MDEL best 90/35 MD-EL	67127	67126	67128	1x35	E27	3800	IP54	⊕	109	A
● best 90/70 MD-EL	67137	67136	67138	1x70	E27	7200	IP54	⊕	103	A

Base tirafondi

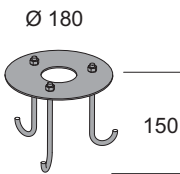

base tirafondi	68990	tirafondi – anchor bolts
----------------	-------	--------------------------

Colore struttura Structure color

AT RAL 7016
Antracite gofrato Embossed anthracite

GR RAL 9006
Grigio gofrato Embossed grey

● **RU**
Ruggine Rust

● Nuova versione New version

● Led Equipaggiata con led 3000K - Equipped with led 3000K

● Led Equipaggiata con led 4000K - Equipped with led 4000K

(a) Equipaggiato con alimentatore multipotenza per l'utilizzo di lampade da 26W-32W o 42W.
Equipped with multi-power ballast to use bulbs of 26W-32W or 42W.

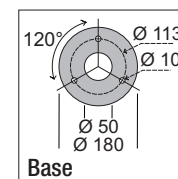

Base

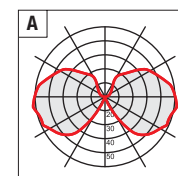
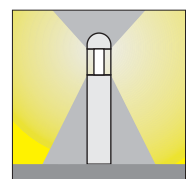

A



uso esterno
outdoor using

Land

Lampione da giardino. Diffusore in policarbonato trasparente. Struttura in alluminio estruso con particolari in pressofusione di alluminio, verniciatura in polvere poliestere con trattamento di fosfatazione. Viti in acciaio inox. Guarnizioni in silicone. Frangiluce lamellare in alluminio per luce direzionata. Fornito con dispositivo per il collegamento di un cavo di ingresso (alimentazione della rete) e due cavi di uscita (alimentazione degli apparecchi a "cascata" in parallelo). Base tirafondi, da interrare nel cemento, acquistabile separatamente.

Bollard. Diffuser made in transparent polycarbonate. Structure made in extruded aluminium and die casting aluminium parts with polyester paint and phosphate treatment. Inox steel screws. Gasket made in silicon rubber. Louvre reflector made in aluminium for directional light. Equipped with a device for connecting an input cable (mains supply) and two output cables (power to devices in "cascade" in parallel). Base with anchor bolts, to be cemented, purchasable separately

Borne. Diffuseur en polycarbonate transparent. Structure réalisée en extrusion d'aluminium avec parties en fonte d'aluminium. Vernis polyester traitement de phosphatation. Vis en acier inox. Joint en gomme de silicone. Réflecteur à lamelles en aluminium pour éclairage directionnelle. Equipé avec dispositif permettant de connecter un câble d'entrée (alimentation secteur) et de deux câbles de sortie (puissance aux dispositifs de la "cascade" en parallèle). Base avec boulons d'ancrage, de enterrer dans le béton, vendu séparément.

Baliza. Difusor de policarbonato transparente. Estructura de aluminio extrudido con detalles fundidos a presión de aluminio, pintura en polvo poliéster con tratamiento de fosfatación. Tornillos de acero inoxidable. Junta de protección de silicona. Reflector laminar en aluminio para iluminación direccional. Suministrado con un dispositivo para conectar un cable de entrada (red eléctrica) y dos cables de salida (energía a los dispositivos en "cascada" en paralelo). Base con pernos de anclaje, para enterrar nel suelo, que se vende separado.

Pollerleuchte. Diffusor aus transparentem Polycarbonat. Struktur aus Aluminium extrusion mit Einzelteilen aus Aludruckguss, Lackierung aus Polyester Pulver mit Phosphatierung. Schrauben aus Edelstahl. Silikondichtungen. Lamellenreflektor aus Aluminium für gerichtetes Licht. Ausgestattet mit einer Vorrichtung zum Anschließen einer Eingangsspannung Kabel (Netz) und zwei Output-Kabel (Stromversorgung von Geräten in "Kaskade" parallel). Sockel mit Ankerbolzen, in Zement begraben werden, separat erhältlich.



Colore struttura Structure color

Land 50

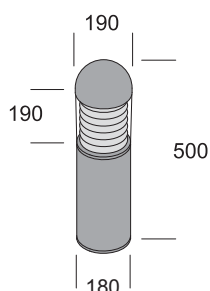

Articolo Item	Colore struttura Structure color			W _{max}	LUMEN	LUMEN/W	LUMEN/W	LUMEN/W	LUMEN/W	
	AT	GR	RU							
E27 land 50	65337	65336	65338	1x57	E27	915	IP54	⊕	16	A
EL land 50 EL	68007	68006	68008	1x42(a)	GX24q-4	3200	IP54	⊕	76	A
● MD EL land 50/70 MD-EL	67147	67146	67148	1x70	E27	7200	IP54	⊕	103	A

Land 90

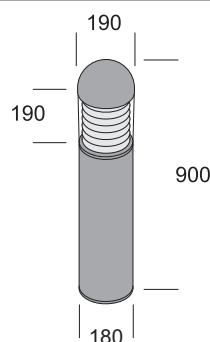

E27 land 90	65357	65356	65358	1x57	E27	915	IP54	⊕	16	A
EL land 90 EL	68877	68876	68878	1x42(a)	GX24q-4	3200	IP54	⊕	76	A
● MD EL land 90/70 MD-EL	67157	67156	67158	1x70	E27	7200	IP54	⊕	103	A

Base tirafondi

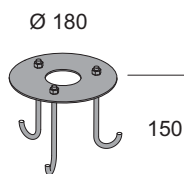

base tirafondi	68990	tirafondi – anchor bolts
-----------------------	-------	--------------------------

Colore struttura Structure color

AT RAL 7016
Antracite gofrato Embossed anthracite

GR RAL 9006
Grigio gofrato Embossed grey

● **RU**
Ruggine Rust

● Nuova versione New version

(a) Equipaggiato con alimentatore multipotenza per l'utilizzo di lampade da 26W-32W o 42W.
Equipped with multi-power ballast to use bulbs of 26W-32W or 42W.

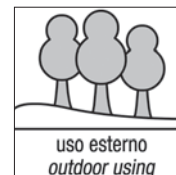
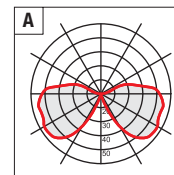
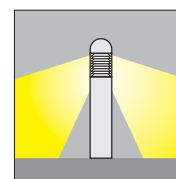
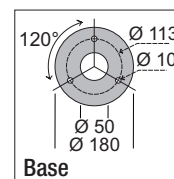

Visor

Lampione da giardino. Diffusore in policarbonato trasparente. Struttura in alluminio estruso con particolari in pressofusione di alluminio, verniciatura in polvere poliestere con trattamento di fosfatazione. Viti in acciaio inox. Guarnizioni in silicone. Frangiluce in alluminio per luce indiretta con diffusione orizzontale. Fornito con dispositivo per il collegamento di un cavo di ingresso (alimentazione della rete) e due cavi di uscita (alimentazione degli apparecchi a "cascata" in parallelo). Base tirafondi, da interrare nel cemento, acquistabile separatamente.

Bollard. Diffuser made in transparent polycarbonate. Structure made in extruded aluminium and die casting aluminium parts with polyester paint and phosphate treatment. Inox steel screws. Gasket made in silicon rubber. Reflector made of aluminium for indirect light with horizontal emission. Equipped with a device for connecting an input cable (mains supply) and two output cables (power to devices in "cascade" in parallel). Base with anchor bolts, to be cemented, purchasable separately.

Borne. Diffuseur en polycarbonate transparent. Structure réalisée en extrusion d'aluminium avec parties en fonte d'aluminium. Vernis polyester traitement de phosphatation. Vis en acier inox. Joint en gomme de silicone. Réflecteur en aluminium pour éclairage indirecte avec émission horizontale. Equipé avec dispositif permettant de connecter un câble d'entrée (alimentation secteur) et de deux câbles de sortie (puissance aux dispositifs de la "cascade" en parallèle). Base avec boulons d'ancrage, de enterrer dans le béton, vendu séparément.

Baliza. Difusor de policarbonato transparente. Estructura de aluminio extrudido con detalles fundidos a presión de aluminio, pintura en polvo poliéster con tratamiento de fosfatación. Tornillos de acero inoxidable. Junta de protección de silicona. Reflector en aluminio para iluminación indirecta con emisión horizontal. Suministrado con un dispositivo para conectar un cable de entrada (red eléctrica) y dos cables de salida (energía a los dispositivos en "cascada" en paralelo). Base con pernos de anclaje, para enterrar nel suelo, que se vende separado.

Pollerleuchte. Diffusor aus transparentem Polycarbonat. Struktur aus Aluminium extrusion mit Einzelteilen aus Aludruckguss, Lackierung aus Polyester Pulver mit Phosphatierung. Schrauben aus Edelstahl. Silikondichtungen. Reflektor aus Aluminium für Horizontal Direktional Lichtemission. Ausgestattet mit einer Vorrichtung zum Anschließen einer Eingangsspannung Kabel (Netz) und zwei Output-Kabel (Stromversorgung von Geräten in "Kaskade" parallel). Sockel mit Ankerbolzen, in Zement begraben werden, separat erhältlich.



Colore struttura Structure color

Visor 50

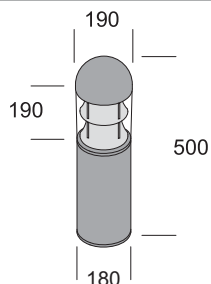

Articolo Item	Colore struttura Structure color			W _{max}		LUMEN		LUMEN/W	
	AT	GR	RU						
EL visor 50 EL	68027	68026	68028	1x42(a)	GX24q-4	3200	IP54	⊕ 76	A
● MD EL visor 50/70 MD-EL	67167	67166	67168	1x70	E27	7200	IP54	⊕ 103	A

Visor 90

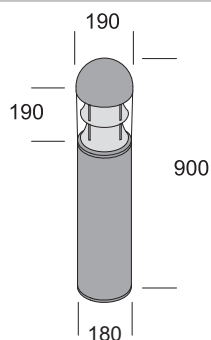

EL visor 90 EL	68897	68896	68898	1x42(a)	GX24q-4	3200	IP54	⊕ 76	A
● MD EL visor 90/70 MD-EL	67177	67176	67178	1x70	E27	7200	IP54	⊕ 103	A

Base tirafondi

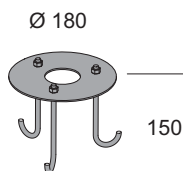

base tirafondi	68990	tirafondi – anchor bolts
----------------	-------	--------------------------

Colore struttura Structure color

AT RAL 7016
Antracite gofrato Embossed anthracite

GR RAL 9006
Grigio gofrato Embossed grey

● RU
Ruggine Rust

● Nuova versione New version

(a) Equipaggiato con alimentatore multipotenza per l'utilizzo di lampade da 26W-32W o 42W.
Equipped with multi-power ballast to use bulbs of 26W-32W or 42W.

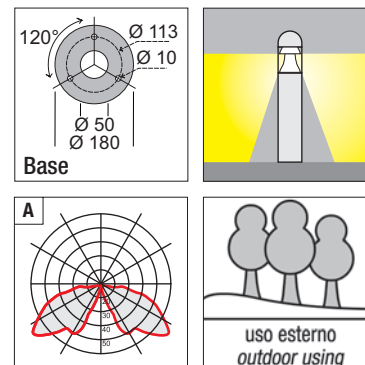

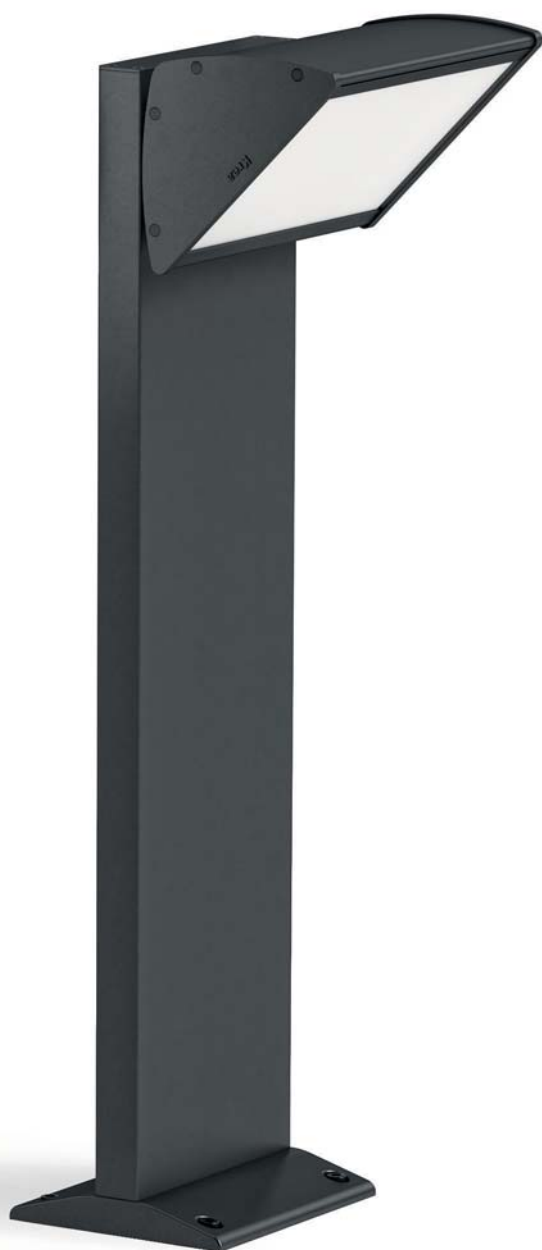

Park

Lampione da giardino. Diffusore in policarbonato colore anice con rigatura prismatica interna. Parabola in metallo verniciato bianco. Struttura e palo in alluminio estruso con particolari in pressofusione di alluminio, verniciatura in polvere poliesteri con trattamento di fosfatazione. Viti in acciaio inox. Guarnizioni in silicone. Fornito con dispositivo per il collegamento di un cavo di ingresso (alimentazione della rete) e due cavi di uscita (alimentazione degli apparecchi a "cascata" in parallelo). **Versione LED equipaggiata con led smd e alimentatore elettronico incorporato.**

Bollard. Diffuser made in polycarbonate colour anise with prismatic ruling inside. Inside reflector made in white painted metal. Structure and pole made in extruded aluminium and die casting aluminium parts with polyester paint and phosphate treatment. Inox steel screws. Gasket made in silicone rubber. Equipped with a device for connecting an input cable (mains supply) and two output cables (power to devices in "cascade" in parallel). **LED version equipped with smd led and electronic driver included.**

Borne. Diffuseur en polycarbonate couleur anis avec réglage prismatique intérieure. Réflecteur intérieur en métal verni blanc. Structure et pilier réalisés en extrusion d'aluminium avec parties en fonte d'aluminium. Vernis polyester traitement de phosphatation. Vis en acier inox. Joint en gomme de silicone. Equipé d'un dispositif permettant de connecter un câble d'entrée (alimentation secteur) et de deux câbles de sortie (puissance aux dispositifs de la "cascade" en parallèle). **Version LED équipée avec led smd et ballast électronique incorporé.**

Baliza. Difusor de policarbonato color anís con estriado prismático interno. Parábola reflectante de metal pintado blanco. Estructura y poste de aluminio extrudido con detalles fundidos a presión de aluminio, pintura en polvo poliéster con tratamiento de fosfatación. Tornillos de acero inoxidable. Junta de protección de silicona. Suministrado con un dispositivo para conectar un cable de entrada (red eléctrica) y dos cables de salida (energía a los dispositivos en "cascada" en paralelo). **Version LED suministrada con led smd y alimentador electrónico incluido.**

Pollerleuchte. Diffusor aus anisfarbenem Polycarbonat innen prismatisch. Parabolspiegel aus weiß lackiertem Metall. Struktur und Ständer aus Aluminium extrusion mit Einzelteilen aus Aludruckguss, Lackierung aus Polyester Pulver mit Phosphatierung. Schrauben aus rostfreiem Stahl. Silikondichtungen. Ausgestattet mit einer Vorrichtung zum Anschließen einer Eingangsspannung Kabel (Netz) und zwei Output-Kabel (Stromversorgung von Geräten in "Kaskade" parallel). **Ausführung LED zum led smd und integriert Versorgungsgesetz elektronisch.**



Colore struttura Structure color

Articolo Item

AT

GR

RU

W_{max}



LUMEN



LUMEN/W



Codice Code

Park 90

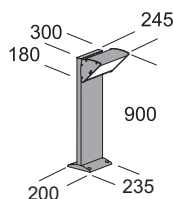

<input type="checkbox"/> E27	park 90	65377	65376	65378	1x46	E27	700	IP65	⊕	15	A
● <input type="checkbox"/> Led	park 90 led-W	59287	59286	59288	23	led	3120	IP65	⊕	136	B
● <input type="checkbox"/> Led	park 90 led-N	59297	59296	59298	23	led	3120	IP65	⊕	136	B
● <input type="checkbox"/> EL	park 90/26 EL	68437	68436	68438	1x26	G24q-3	1800	IP65	⊕	69	A

Park 180

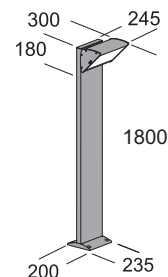

<input type="checkbox"/> E27	park 180	65397	65396	65398	1x46	E27	700	IP65	⊕	15	A
● <input type="checkbox"/> Led	park 180 led-W	59307	59306	59308	23	led	3120	IP65	⊕	136	B
● <input type="checkbox"/> Led	park 180 led-N	59317	59316	59318	23	led	3120	IP65	⊕	136	B
● <input type="checkbox"/> EL	park 180/26 EL	68447	68446	68448	1x26	G24q-3	1800	IP65	⊕	69	A

Park 92

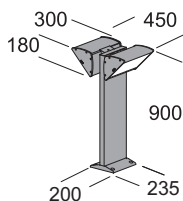

<input type="checkbox"/> E27	park 92	65387	65386	65388	2x46	E27	1400	IP65	⊕	15	A
● <input type="checkbox"/> Led	park 92 led-W	59327	59326	59328	46	led	6240	IP65	⊕	136	B
● <input type="checkbox"/> Led	park 92 led-N	59337	59336	59338	46	led	6240	IP65	⊕	136	B
● <input type="checkbox"/> EL	park 92/2x26 EL	68457	68456	68458	2x26	G24q-3	3600	IP65	⊕	69	A

Park 182

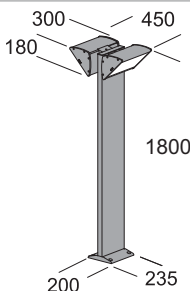

<input type="checkbox"/> E27	park 182	65407	65406	65408	2x46	E27	1400	IP65	⊕	15	A
● <input type="checkbox"/> Led	park 182 led-W	59347	59346	59348	46	led	6240	IP65	⊕	136	B
● <input type="checkbox"/> Led	park 182 led-N	59357	59356	59358	46	led	6240	IP65	⊕	136	B
● <input type="checkbox"/> EL	park 182/2x26 EL	68467	68466	68468	2x26	G24q-3	3600	IP65	⊕	69	A

Colore struttura Structure color

● Nuova versione New version

AT **RAL 7016**

Antracite goffrato Embossed anthracite

GR **RAL 9006**

Grigio goffrato Embossed grey

● RU

Ruggine Rust

Led Equipaggiata con led 3000K - Equipped with led 3000K

Led Equipaggiata con led 4000K - Equipped with led 4000K

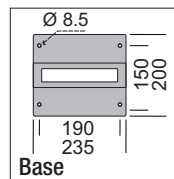

Base

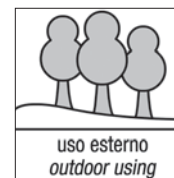
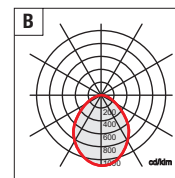
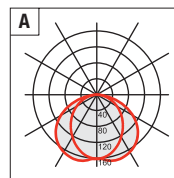
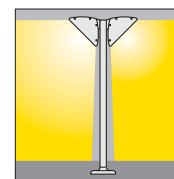
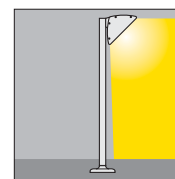

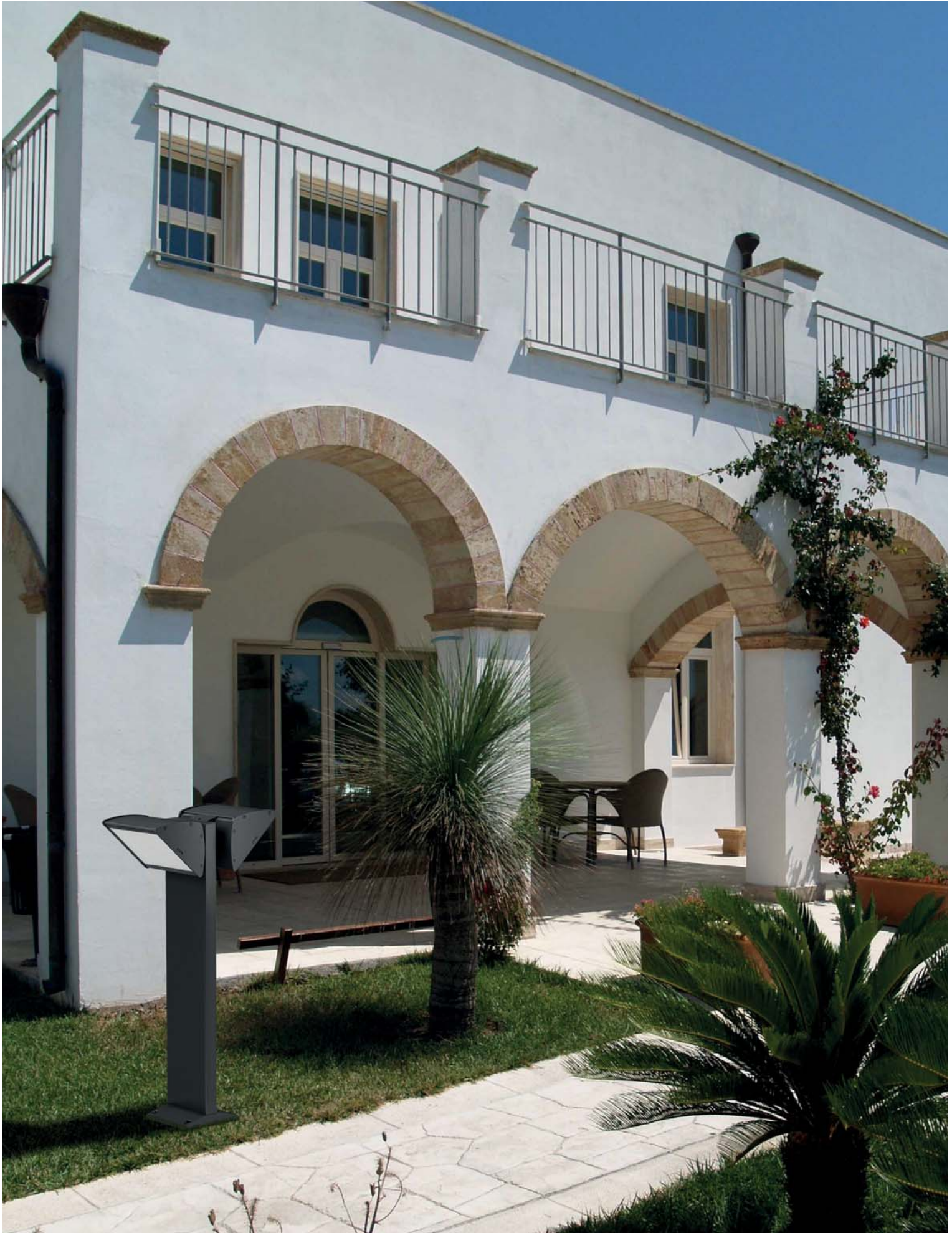

14 applique interni/esterni
wall lights indoor/outdoor

150 plafoniere interni/esterni
ceiling bowls indoor/outdoor

248 testataletto
bed head units

258 sospensioni
suspensions

344 lampade
lamps

384 lampioni ed incassi
bollards & recessed lights

450 indice
index

Plaza

Lampione da giardino. Diffusore in policarbonato colore anice con rigatura prismatica interna. Parabola in metallo verniciato bianco. Struttura e palo in alluminio estruso con particolari in pressofusione di alluminio, verniciatura in polvere poliestere con trattamento di fosfatazione. Viti in acciaio inox. Guarnizioni in silicone. Fornito con dispositivo per il collegamento di un cavo di ingresso (alimentazione della rete) e due cavi di uscita (alimentazione degli apparecchi a "cascata" in parallelo). **Versione LED equipaggiata con led smd e alimentatore elettronico incorporato.**

Bollard. Diffuser made in polycarbonate colour anise with prismatic ruling inside. Inside reflector made in white painted metal. Structure and pole made in extruded aluminium and die casting aluminium parts with polyester paint and phosphate treatment. Inox steel screws. Gasket made in silicone rubber. Equipped with a device for connecting an input cable (mains supply) and two output cables (power to devices in "cascade" in parallel). **LED version equipped with smd led and electronic driver included.**

Borne. Diffuseur en polycarbonate couleur anis avec réglage prismatique intérieure. Réflecteur intérieur en métal verni blanc. Structure et pilier réalisés en extrusion d'aluminium avec parties en fonte d'aluminium. Vernis polyester traitement de phosphatation. Vis en acier inox. Joint en gomme de silicone. Equipé d'un dispositif permettant de connecter un câble d'entrée (alimentation secteur) et de deux câbles de sortie (puissance aux dispositifs de la "cascade" en parallèle). **Versión LED equipada avec led smd et ballast electrónico incorporé.**

Baliza. Difusor de policarbonato color anís con estriado prismático interno. Parábola reflectante de metal pintado blanco. Estructura y poste de aluminio extrudido con detalles fundidos a presión de aluminio, pintura en polvo poliéster con tratamiento de fosfatación. Tornillos de acero inoxidable. Junta de protección de silicona. Suministrado con un dispositivo para conectar un cable de entrada (red eléctrica) y dos cables de salida (energía a los dispositivos en "cascada" en paralelo). **Versión LED suministrada con led smd y alimentador electrónico incluido.**

Pollerleuchte. Diffusor aus anisfarbenem Polycarbonat innen prismatisch. Parabolspiegel aus weiß lackiertem Metall. Struktur und Ständer aus Aluminium extrusion mit Einzelteilen aus Aludruckguss, Lackierung aus Polyester Pulver mit Phosphatierung. Schrauben aus rostfreiem Stahl. Silikondichtungen. Ausgestattet mit einer Vorrichtung zum Anschließen einer Eingangsspannung Kabel (Netz) und zwei Output-Kabel (Stromversorgung von Geräten in "Kaskade" parallel). **Ausführung LED zum led smd und integriert Versorgungsgerät elektronisch.**





Colore struttura Structure color

Articolo Item

AT

GR

RU

W_{max}



LUMEN



LUMEN/W



Codice Code

Plaza 90

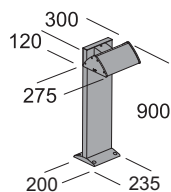

E27	plaza 90	65417	65416	65418	1x46	E27	700	IP65	⊕	15	A
Led	plaza 90 led-W	59367	59366	59368	23	led	3120	IP65	⊕	136	B
Led	plaza 90 led-N	59377	59376	59378	23	led	3120	IP65	⊕	136	B
EL	plaza 90/26 EL	68477	68476	68478	1x26	G24q-3	1800	IP65	⊕	69	A

Plaza 180

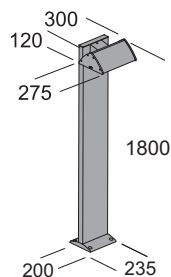

E27	plaza 180	65437	65436	65438	1x46	E27	700	IP65	⊕	15	A
Led	plaza 180 led-W	59387	59386	59388	23	led	3120	IP65	⊕	136	B
Led	plaza 180 led-N	59397	59396	59398	23	led	3120	IP65	⊕	136	B
EL	plaza 180/26 EL	68487	68486	68488	1x26	G24q-3	1800	IP65	⊕	69	A

Plaza 92

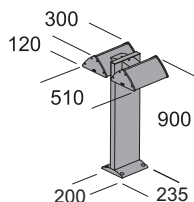

E27	plaza 92	65427	65426	65428	2x46	E27	1400	IP65	⊕	15	A
Led	plaza 92 led-W	59407	59406	59408	46	led	6240	IP65	⊕	136	B
Led	plaza 92 led-N	59417	59416	59418	46	led	6240	IP65	⊕	136	B
EL	plaza 92/2x26 EL	68497	68496	68498	2x26	G24q-3	3600	IP65	⊕	69	A

Plaza 182

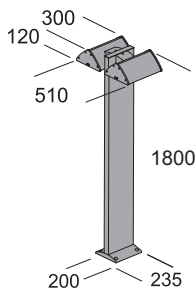

E27	plaza 182	65447	65446	65448	2x46	E27	1400	IP65	⊕	15	A
Led	plaza 182 led-W	59427	59426	59428	46	led	6240	IP65	⊕	136	B
Led	plaza 182 led-N	59437	59436	59438	46	led	6240	IP65	⊕	136	B
EL	plaza 182/2x26 EL	68507	68506	68508	2x26	G24q-3	3600	IP65	⊕	69	A

Colore struttura Structure color

● Nuova versione New version

AT RAL 7016
Antracite goffrato Embossed anthracite

GR RAL 9006
Grigio goffrato Embossed grey

● RU
Ruggine Rust

Led Equipaggiata con led 3000K - Equipped with led 3000K

Led Equipaggiata con led 4000K - Equipped with led 4000K

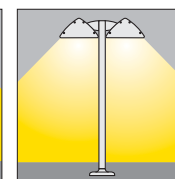
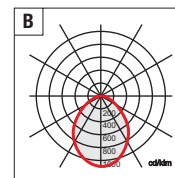
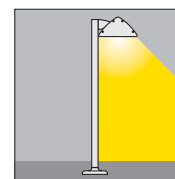
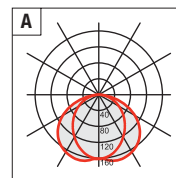
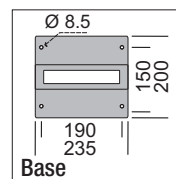



14 applique interni/esterni
wall lights indoor/outdoor

150 plafoniere interni/esterni
ceiling bowls indoor/outdoor

248 testataletto
bed head units

258 sospensioni
suspensions

344 lampade
lamps

384 lampioni ed incassi
bollards & recessed lights

450 indice
index

Box

Lampione da giardino. Diffusore in policarbonato colore anice con rigatura prismatica interna. Struttura in alluminio estruso con particolari in pressofusione di alluminio, verniciatura in polvere poliestere con trattamento di fosfatazione. Viti in acciaio inox. Guarnizioni in silicone. Fornito con dispositivo per il collegamento di un cavo di ingresso (alimentazione della rete) e due cavi di uscita (alimentazione degli apparecchi a "cascata" in parallelo). **Versione LED equipaggiata con led smd e alimentatore elettronico incorporato.** Disponibile frangiluce in alluminio.

Bollard. Diffuser in polycarbonate colour anise with prismatic ruling inside. Structure made in extruded aluminium and die casting aluminium parts with polyester paint and phosphate treatment. Inox steel screws. Gasket made in silicon rubber. Equipped with a device for connecting an input cable (mains supply) and two output cables (power to devices in "cascade" in parallel). **LED version equipped with smd led and electronic driver included.** Available louvred reflector made of aluminum.

Borne. Diffuseur en polycarbonate couleur anis avec réglage prismatique intérieure. Structure réalisée en extrusion d'aluminium avec parties en fonte d'aluminium. Vernis polyester traitement de phosphatation. Vis en acier inox. Joint en gomme de silicone. Equipé d'un dispositif permettant de connecter un câble d'entrée (alimentation secteur) et de deux câbles de sortie (puissance aux dispositifs de la "cascade" en parallèle). **Version LED équipée avec led smd et ballast électronique incorporé.** Disponible réflecteur à lamelles en aluminium.

Baliza. Difusor de policarbonato color anís con estriado prismático interno. Estructura de aluminio extrudido con detalles fundidos a presión de aluminio, pintura en polvo poliéster con tratamiento de fosfatación. Tornillos de acero inoxidable. Junta de protección de silicona. Suministrado con un dispositivo para conectar un cable de entrada (red eléctrica) y dos cables de salida (energía a los dispositivos en "cascada" en paralelo). **Version LED suministrada con led smd y alimentador electrónico incluido.** Disponible reflector de lamas en aluminio.

Pollerleuchte. Diffusor aus anisfarbenem Polycarbonat innen prismatisch. Struktur aus Aluminium extrusion mit Einzelteilen aus Aludruckguss, Lackierung aus Polyester Pulver mit Phosphatierung. Schrauben aus Edelstahl. Silikondichtungen. Ausgestattet mit einer Vorrichtung zum Anschließen einer Eingangsspannung Kabel (Netz) und zwei Output-Kabel (Stromversorgung von Geräten in "Kaskade" parallel). **Ausführung LED zum led smd und integriert Versorgungsgerät elektronisch.** Lamellenreflektor aus Aluminium.



14 applique interni/esterni
wall lights indoor/outdoor

150 plafoniere interni/esterni
ceiling bowls indoor/outdoor

248 testaletto
bed head units

258 sospensioni
suspensions

344 lampade
lamps

384 lampioni ed incassi
bollards & recessed lights

450 indice
index

Colore struttura Structure color

Articolo Item

AT

GR

RU

W_{max}



LUMEN



LUMEN/W



Codice Code

Box 30A

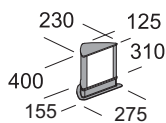

box 30A	65007	65006	65008	1x46	E27	700	IP65	⊕	15	A
box 30A led-W	59447	59446	59448	23	led	3120	IP65	⊕	136	B
box 30A led-N	59457	59456	59458	23	led	3120	IP65	⊕	136	B
box 30A/26 EL	68517	68516	68518	1x26	G24q-3	1800	IP65	⊕	69	A

Box 30B

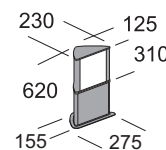

box 30B	65017	65016	65018	1x46	E27	700	IP65	⊕	15	A
box 30B led-W	59467	59466	59468	23	led	3120	IP65	⊕	136	B
box 30B led-N	59477	59476	59478	23	led	3120	IP65	⊕	136	B
box 30B/26 EL	68527	68526	68528	1x26	G24q-3	1800	IP65	⊕	69	A

Box 30C

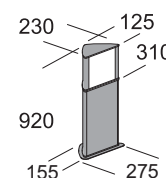

box 30C	65027	65026	65028	1x46	E27	700	IP65	⊕	15	A
box 30C led-W	59487	59486	59488	23	led	3120	IP65	⊕	136	B
box 30C led-N	59497	59496	59498	23	led	3120	IP65	⊕	136	B
box 30C/26 EL	68537	68536	68538	1x26	G24q-3	1800	IP65	⊕	69	A

Frangiluce Box 30

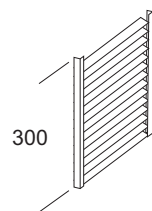

frangiluce 30

69991

frangiluce in alluminio - aluminium breaklight

Colore struttura Structure color

Nuova versione New version

RAL 7016

Antracite gofrato Embossed anthracite

RAL 9006

Grigio gofrato Embossed grey

RU

Ruggine Rust

Equipaggiata con led 3000K - Equipped with led 3000K

Equipaggiata con led 4000K - Equipped with led 4000K

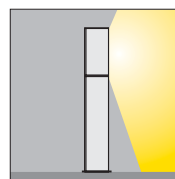

senza frangiluce
without breaklight

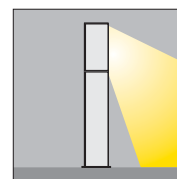

con frangiluce
with breaklight

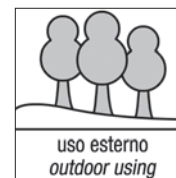
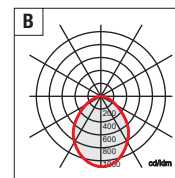
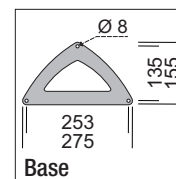
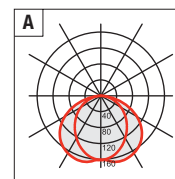

Colore struttura Structure color

Box 60A

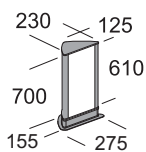

Articolo Item	Colore struttura Structure color			W _{max}	Lamp	LUMEN	IP	⊕	LUMEN/W	Beam
	AT	GR	RU							
● Led box 60A led-W	59507	59506	59508	45,8	led	6260	IP65	⊕	137	B
● Led box 60A led-N	59517	59516	59518	45,8	led	6260	IP65	⊕	137	B
EL box 60A/2x24 EL	66147	66146	66148	2x24	G5	4000	IP65	⊕	83	A
box 60A/2x36 EL	67077	67076	67078	2x36	2G11	5800	IP65	⊕	81	A

Box 60B

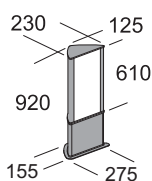

● Led box 60B led-W	59527	59526	59528	45,8	led	6260	IP65	⊕	137	B
● Led box 60B led-N	59537	59536	59538	45,8	led	6260	IP65	⊕	137	B
EL box 60B/2x24 EL	66207	66206	66208	2x24	G5	4000	IP65	⊕	83	A
box 60B/2x36 EL	67087	67086	67088	2x36	2G11	5800	IP65	⊕	81	A

Box 60C

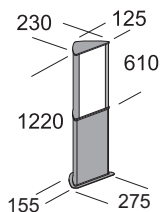

● Led box 60C led-W	59547	59546	59548	45,8	led	6260	IP65	⊕	137	B
● Led box 60C led-N	59557	59556	59558	45,8	led	6260	IP65	⊕	137	B
EL box 60C/2x24 EL	66267	66266	66268	2x24	G5	4000	IP65	⊕	83	A
box 60C/2x36 EL	67097	67096	67098	2x36	2G11	5800	IP65	⊕	81	A

Frangiluce Box 60

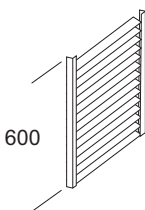

frangiluce 60 69992 frangiluce in alluminio - aluminium breaklight

Colore struttura Structure color

● Nuova versione New version

AT RAL 7016
Antracite gofrato Embossed anthracite

GR RAL 9006
Grigio gofrato Embossed grey

● **RU**
Ruggine Rust

- Led Equipaggiata con led 3000K - Equipped with led 3000K
- Led Equipaggiata con led 4000K - Equipped with led 4000K

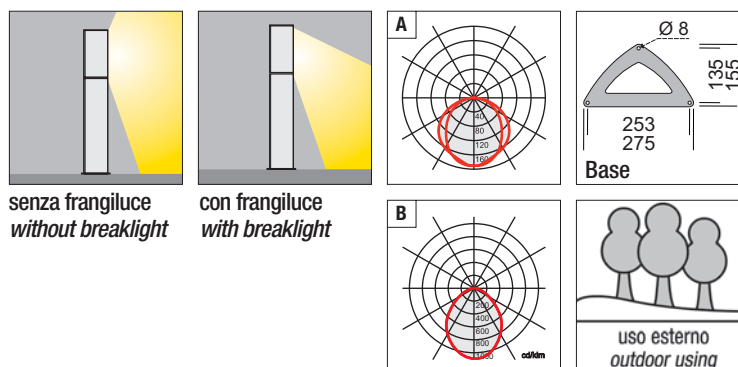

Colore struttura Structure color

Articolo Item

AT

GR

RU

W_{max}



LUMEN



LUMEN/W



Codice Code

Box 120A

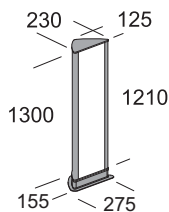

● Led	box 120A led-W	59567	59566	59568	45,8	led	6260	IP65	⊕	137	B
●	box 120AS led-W	59577	59576	59578	91,6	led	12520	IP65	⊕	137	B
● Led	box 120A led-N	59587	59586	59588	45,8	led	6260	IP65	⊕	137	B
●	box 120AS led-N	59597	59596	59598	91,6	led	12520	IP65	⊕	137	B
EL	box 120A/2x54 EL	66307	66306	66308	2x54	G5	10000	IP65	⊕	93	A

Box 120B

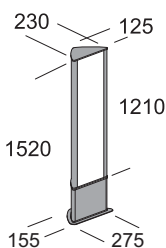

● Led	box 120B led-W	59607	59606	59608	45,8	led	6260	IP65	⊕	137	B
●	box 120BS led-W	59617	59616	59618	91,6	led	12520	IP65	⊕	137	B
● Led	box 120B led-N	59627	59626	59628	45,8	led	6260	IP65	⊕	137	B
●	box 120BS led-N	59637	59636	59638	91,6	led	12520	IP65	⊕	137	B
EL	box 120B/2x54 EL	66347	66346	66348	2x54	G5	10000	IP65	⊕	93	A

Box 120C

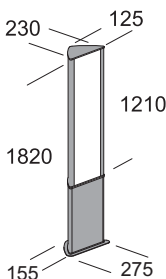

● Led	box 120C led-W	59647	59646	59648	45,8	led	6260	IP65	⊕	137	B
●	box 120CS led-W	59657	59656	59658	91,6	led	12520	IP65	⊕	137	B
● Led	box 120C led-N	59667	59666	59668	45,8	led	6260	IP65	⊕	137	B
●	box 120CS led-N	59677	59676	59678	91,6	led	12520	IP65	⊕	137	B
EL	box 120C/2x54 EL	66387	66386	66388	2x54	G5	10000	IP65	⊕	93	A

Frangiluce Box 120

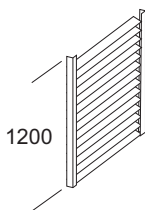

frangiluce 120

69993

frangiluce in alluminio - aluminium breaklight

Colore struttura Structure color

● Nuova versione New version

AT RAL 7016

Antracite goffrato Embossed anthracite

GR RAL 9006

Grigio goffrato Embossed grey

● RU

Ruggine Rust

● Led Equipaggiata con led 3000K - Equipped with led 3000K

● Led Equipaggiata con led 4000K - Equipped with led 4000K

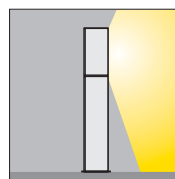

senza frangiluce
without breaklight

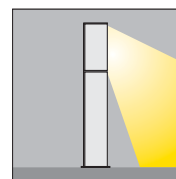

con frangiluce
with breaklight

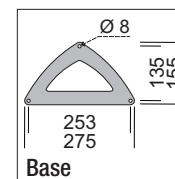
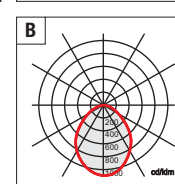
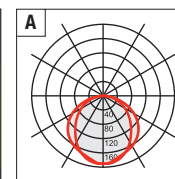

uso esterno
outdoor using

Colore struttura Structure color

Box 150A

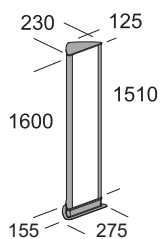

Articolo Item	Colore struttura Structure color			W _{max}	LUMEN	LUMEN/W	LUMEN/W	LUMEN/W
	AT	GR	RU					
● Led box 150A led-W	59687	59686	59688	57,3	led 7820	IP65	⊕	136 B
● box 150AS led-W	59697	59696	59698	114,6	led 15640	IP65	⊕	136 B
● Led box 150A led-N	59707	59706	59708	57,3	led 7820	IP65	⊕	136 B
● box 150AS led-N	59717	59716	59718	114,6	led 15640	IP65	⊕	136 B
EL box 150A/2x80 EL	66427	66426	66428	2x80	G5 14000	IP65	⊕	87 A

Box 150B

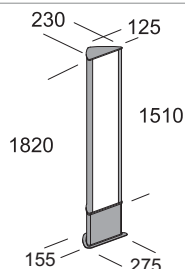

● Led box 150B led-W	59727	59726	59728	57,3	led 7820	IP65	⊕	136 B
● box 150BS led-W	59737	59736	59738	114,6	led 15640	IP65	⊕	136 B
● Led box 150B led-N	59747	59746	59748	57,3	led 7820	IP65	⊕	136 B
● box 150BS led-N	59757	59756	59758	114,6	led 15640	IP65	⊕	136 B
EL box 150B/2x80 EL	66467	66466	66468	2x80	G5 14000	IP65	⊕	87 A

Box 150C

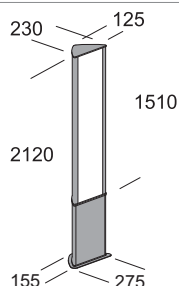

● Led box 150C led-W	59767	59766	59768	57,3	led 7820	IP65	⊕	136 B
● box 150CS led-W	59777	59776	59778	114,6	led 15640	IP65	⊕	136 B
● Led box 150C led-N	59787	59786	59788	57,3	led 7820	IP65	⊕	136 B
● box 150CS led-N	59797	59796	59798	114,6	led 15640	IP65	⊕	136 B
EL box 150C/2x80 EL	66507	66506	66508	2x80	G5 14000	IP65	⊕	87 A

Frangiluce Box 150

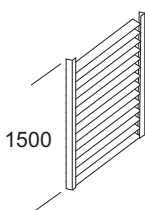

frangiluce 150 69994 frangiluce in alluminio - aluminium breaklight

Colore struttura Structure color

AT RAL 7016
Antracite gofrato Embossed anthracite

GR RAL 9006
Grigio gofrato Embossed grey

● **RU**
Ruggine Rust

● Nuova versione New version

● Led Equipaggiata con led 3000K - Equipped with led 3000K

● Led Equipaggiata con led 4000K - Equipped with led 4000K

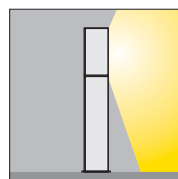

senza frangiluce
without breaklight

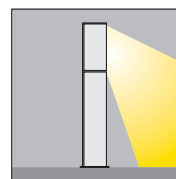

con frangiluce
with breaklight

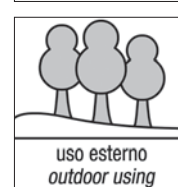
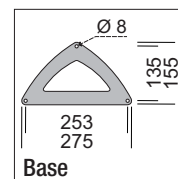
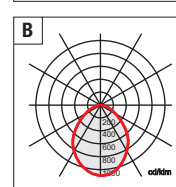
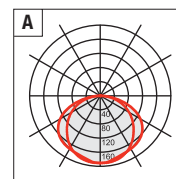

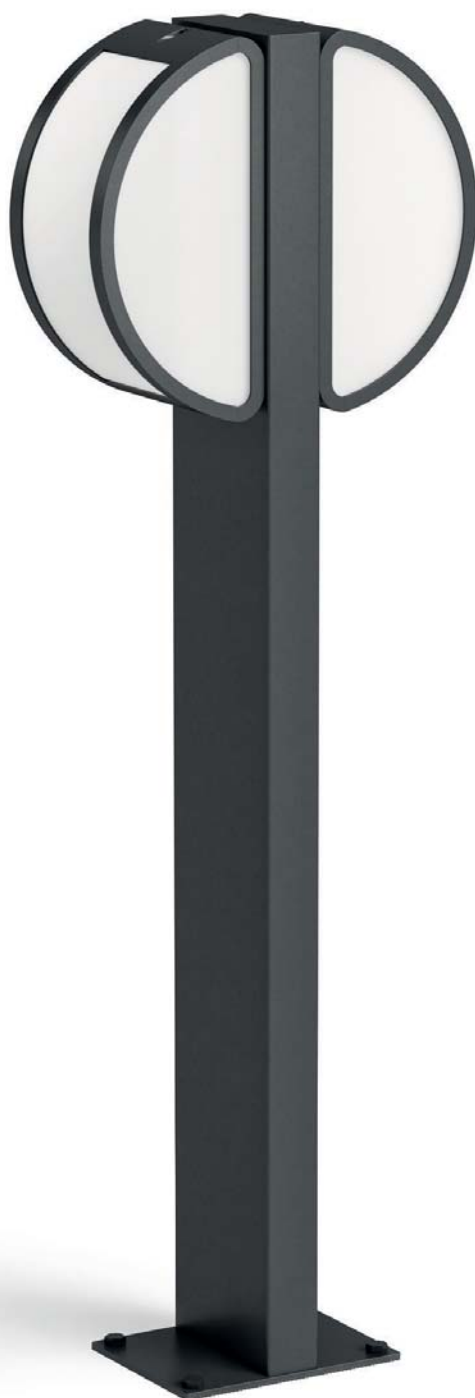

Polo

Lampione da giardino. Diffusore in policarbonato opale. Struttura in pressofusione di alluminio, palo in alluminio estruso con particolari in pressofusione di alluminio, verniciatura in polvere poliestere con trattamento di fosfatazione. Viti in acciaio inox. Guarnizioni in gomma ai polimeri. Fornito con dispositivo per il collegamento di un cavo di ingresso (alimentazione della rete) e due cavi di uscita (alimentazione degli apparecchi a "cascata" in parallelo). **Versione LED equipaggiata con led smd.**

Bollard. Diffuser made in opal polycarbonate. Structure made in die casting aluminium, pole made in extruded aluminium and die casting aluminium parts with polyester paint and phosphate treatment. Inox steel screws. Gasket made in rubber. Equipped with a device for connecting an input cable (mains supply) and two output cables (power to devices in "cascade" in parallel). **LED version equipped with smd led.**

Borne. Diffuseur en polycarbonate opale. Structure réalisée en fonte d'aluminium, pilier réalisé en extrusion d'aluminium avec parties en fonte d'aluminium. Vernis polyester traitement de phosphatation. Vis en acier inox. Joint en gomme. Equipé d'un dispositif permettant de connecter un câble d'entrée (alimentation secteur) et de deux câbles de sortie (puissance aux dispositifs de la "cascade" en parallèle). **Version LED équipée avec led smd.**

Baliza. Difusor de policarbonato opal. Estructura en fundición a presión de aluminio, poste de aluminio extrudido con detalles fundidos a presión de aluminio, pintura en polvo poliéster con tratamiento de fosfatación. Tornillos de acero inoxidable. Junta de protección de goma. Suministrado con un dispositivo para conectar un cable de entrada (red eléctrica) y dos cables de salida (energía a los dispositivos en "cascada" en paralelo). **Version LED suministrada con led smd.**

Pollerleuchte. Diffusor aus opalem Polycarbonat. Struktur aus Aludruckguss, Ständer aus Aluminium extrusion mit Einzelteilen aus Aludruckguss, Lackierung aus Polyester Pulver mit Phosphatierung. Schrauben aus Edelstahl. Dichtungen aus Polymergummi. Ausgestattet mit einer Vorrichtung zum Anschließen einer Eingangsspannung Kabel (Netz) und zwei Output-Kabel (Stromversorgung von Geräten in "Kaskade" parallel). **Ausgestattet mit smd-led.**

Colore struttura Structure color

Polo 60

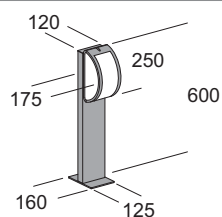

Articolo Item	Colore struttura Structure color			W _{max}	E27	LUMEN	IP54	LUMEN/W	A
	AT	GR	RU						
E27 polo 60	65217	65216	65218	1x46	E27	700	IP54	15	A
● Led polo 60 led-W	59807	59806	59808	13,5	led	1500	IP54	111	A
● Led polo 60 led-N	59817	59816	59818	13,5	led	1500	IP54	111	A

Polo 100

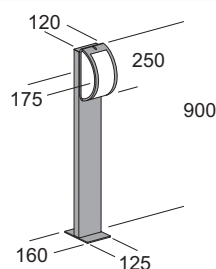

E27 polo 100	65237	65236	65238	1x46	E27	700	IP54	15	A
● Led polo 100 led-W	59847	59846	59848	13,5	led	1500	IP54	111	A
● Led polo 100 led-N	59857	59856	59858	13,5	led	1500	IP54	111	A

Polo 62

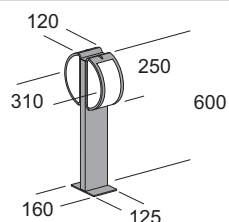

E27 polo 62	65227	65226	65228	2x46	E27	1400	IP54	15	A
● Led polo 62 led-W	59827	59826	59828	27	led	3000	IP54	111	A
● Led polo 62 led-N	59837	59836	59838	27	led	3000	IP54	111	A

Polo 102

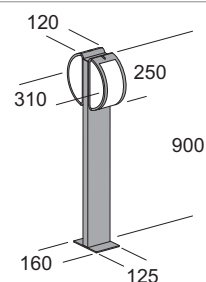

E27 polo 102	65247	65246	65248	2x46	E27	1400	IP54	15	A
● Led polo 102 led-W	59867	59866	59868	27	led	3000	IP54	111	A
● Led polo 102 led-N	59877	59876	59878	27	led	3000	IP54	111	A

Colore struttura Structure color

● Nuova versione New version

AT RAL 7016
Antracite gofrato Embossed anthracite

GR RAL 9006
Grigio gofrato Embossed grey

● **RU**
Ruggine Rust

Led Equipaggiata con led 3000K - Equipped with led 3000K

Led Equipaggiata con led 4000K - Equipped with led 4000K

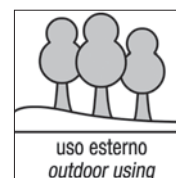
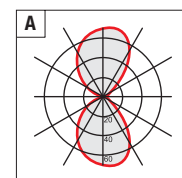
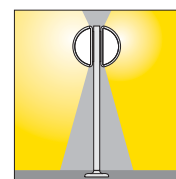
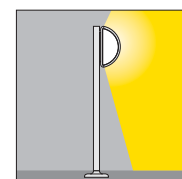
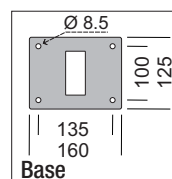

Alfa

Lampade da parete e da soffitto. Diffusore in vetro pressato sabbato internamente. Struttura in pressofusione di alluminio, verniciatura in polvere poliestere con trattamento di fosfatazione. Viti in acciaio inox. Guarnizioni in gomma ai polimeri. **Versione LED equipaggiata con led smd e alimentatore elettronico incorporato.**

Wall and ceiling lamps. Diffuser made in pressed glass with sandblasted inside surface. Structure made in die casting aluminium with polyester paint and phosphate treatment. Inox steel screws. Gasket made in rubber. **LED version equipped with smd led and electronic driver included.**

Lampes à mur et à plafond. Diffuseur en verre pressé sablé à l'intérieur. Structure réalisée en fonte d'aluminium avec vernie polyester et traitement de phosphatation. Vis en acier inox. Joint en gomme. **Version LED équipée avec led smd et ballast électronique incorporé.**

Lámparas de pared y de techo. Difusor de vidrio presado arenado internamente. Estructura en fundición a presión de aluminio con pintura en polvo poliéster y tratamiento de fosfatación. Tornillos de acero inoxidable. Junta de protección de goma. **Version LED suministrada con led smd y alimentador electrónico incluido.**

Wand- und Deckenleuchten. Diffusor aus Pressglas, innen sandgestrahlt. Struktur aus Aluminiumdruckguss, Lackierung aus Polyester Pulver mit Phosphatierung. Schrauben aus Edelstahl. Dichtungen aus Polymergummi. **Ausführung LED zum led smd und integriert Versorgungsgerät elektronisch.**



14 applique interni/esterni
wall lights indoor/outdoor

150 plafoniere interni/esterni
ceiling bowls indoor/outdoor

248 testaletto
bed head units

258 sospensioni
suspensions

344 lampade
lamps

384 lampioni ed incassi
bollards & recessed lights

450 indice
index

Colore struttura Structure color

Articolo Item

AT

BI

GR

RU

W_{max}

LUMEN



LUMEN/W



Codice Code

A1 100

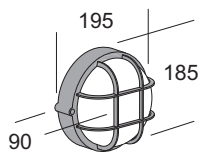

Articolo Item	AT	BI	GR	RU	W _{max}	LUMEN	LUMEN/W
E27 A1 100	51007	51001	51006	51008	1x57	E27 915	IP65 16 A
● Led A1 100 led-W	55757	55751	55756	55758	5,6	led 640	IP65 114 A
● Led A1 100 led-N	55767	55761	55766	55768	5,6	led 640	IP65 114 A

A1 200

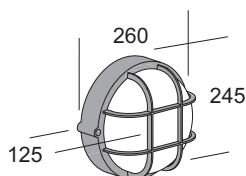

Articolo Item	AT	BI	GR	RU	W _{max}	LUMEN	LUMEN/W
E27 A1 200	51017	51011	51016	51018	1x77	E27 1320	IP65 17 A
● Led A1 200 led-W	55777	55771	55776	55778	8	led 920	IP65 115 A
● Led A1 200 led-N	55787	55781	55786	55788	8	led 920	IP65 115 A

A2 100

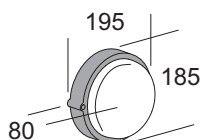

Articolo Item	AT	BI	GR	RU	W _{max}	LUMEN	LUMEN/W
E27 A2 100	51027	51021	51026	51028	1x57	E27 915	IP65 16 A
● Led A2 100 led-W	55797	55791	55796	55798	5,6	led 640	IP65 114 A
● Led A2 100 led-N	55807	55801	55806	55808	5,6	led 640	IP65 114 A

A2 200

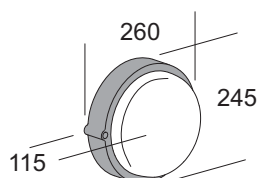

Articolo Item	AT	BI	GR	RU	W _{max}	LUMEN	LUMEN/W
E27 A2 200	51037	51031	51036	51038	1x77	E27 1320	IP65 17 A
● Led A2 200 led-W	55817	55811	55816	55818	8	led 920	IP65 115 A
● Led A2 200 led-N	55827	55821	55826	55828	8	led 920	IP65 115 A

Colore struttura Structure color

AT RAL 7016

Antracite gofrato Embossed anthracite

BI RAL 9016

Bianco gofrato Embossed white

GR RAL 9006

Grigio gofrato Embossed grey

● RU

Ruggine Rust

● Nuova versione New version

● Led Equipaggiata con led 3000K - Equipped with led 3000K

● Led Equipaggiata con led 4000K - Equipped with led 4000K

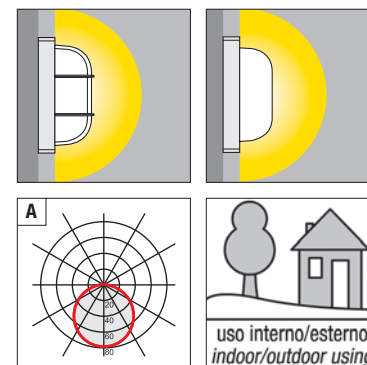

Colore struttura Structure color

A3 100

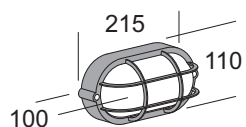

Articolo Item	Colore struttura Structure color				W _{max}	LUMEN	IP	LUMEN/W	A	
	AT	BI	GR	RU						
	Codice Code									
E27 A3 100	51047	51041	51046	51048	1x46	700	IP65	⊕	15	A
● Led A3 100 led-W	55837	55831	55836	55838	3,5	360	IP65	⊕	103	A
● Led A3 100 led-N	55847	55841	55846	55848	3,5	360	IP65	⊕	103	A

A3 200

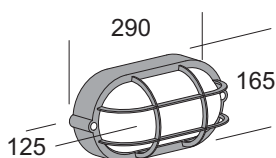

E27 A3 200	51057	51051	51056	51058	1x77	1320	IP65	⊕	17	A
● Led A3 200 led-W	55857	55851	55856	55858	6,3	750	IP65	⊕	119	A
● Led A3 200 led-N	55867	55861	55866	55868	6,3	750	IP65	⊕	119	A

A4 100

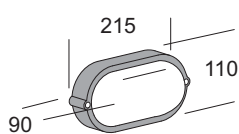

E27 A4 100	51067	51061	51066	51068	1x46	700	IP65	⊕	15	A
● Led A4 100 led-W	55877	55871	55876	55878	3,5	360	IP65	⊕	103	A
● Led A4 100 led-N	55887	55881	55886	55888	3,5	360	IP65	⊕	103	A

A4 200

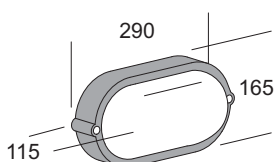

E27 A4 200	51077	51071	51076	51078	1x77	1320	IP65	⊕	17	A
● Led A4 200 led-W	55897	55891	55896	55898	6,3	750	IP65	⊕	119	A
● Led A4 200 led-N	55907	55901	55906	55908	6,3	750	IP65	⊕	119	A

Colore struttura Structure color

AT RAL 7016
Antracite gofrato Embossed anthracite

BI RAL 9016
Bianco gofrato Embossed white

GR RAL 9006
Grigio gofrato Embossed grey

● **RU**
Ruggine Rust

● Led Equipaggiata con led 3000K - Equipped with led 3000K

● Led Equipaggiata con led 4000K - Equipped with led 4000K

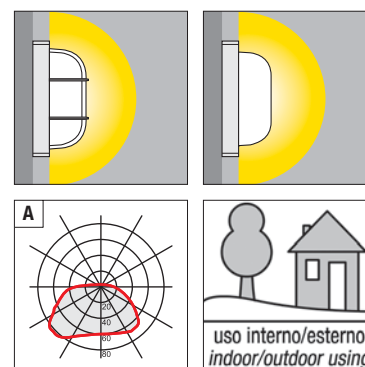

Colore struttura Structure color

A6 200

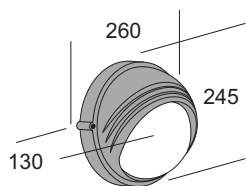

Articolo Item	Colore struttura Structure color				W _{max}	LUMEN	LUMEN/W	LUMEN/W	LUMEN/W		
	AT	BI	GR	RU							
E27 A6 200	51087	51081	51086	51088	1x77	E27	1320	IP65	⊕	17	A
● Led A6 200 led-W	55917	55911	55916	55918	8	led	920	IP65	⊕	115	A
● Led A6 200 led-N	55927	55921	55926	55928	8	led	920	IP65	⊕	115	A

A7 200

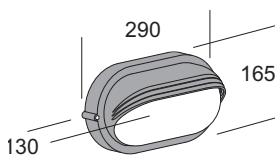

E27 A7 200	51097	51091	51096	51098	1x77	E27	1320	IP65	⊕	17	B
● Led A7 200 led-W	55937	55931	55936	55938	6,3	led	750	IP65	⊕	119	B
● Led A7 200 led-N	55947	55941	55946	55948	6,3	led	750	IP65	⊕	119	B

A8 200

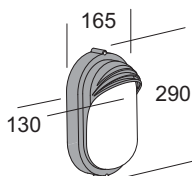

E27 A8 200	51107	51101	51106	51108	1x77	E27	1320	IP65	⊕	17	C
● Led A8 200 led-W	55957	55951	55956	55958	6,3	led	750	IP65	⊕	119	C
● Led A8 200 led-N	55967	55961	55966	55968	6,3	led	750	IP65	⊕	119	C

Colore struttura Structure color

● Nuova versione New version

AT RAL 7016 Antracite gofrato Embossed anthracite	BI RAL 9016 Bianco gofrato Embossed white	GR RAL 9006 Grigio gofrato Embossed grey	RU Ruggine Rust
---	---	--	---------------------------

● Led Equipaggiata con led 3000K - Equipped with led 3000K

● Led Equipaggiata con led 4000K - Equipped with led 4000K

A6

A7

A8

A

B

C

uso interno/esterno
indoor/outdoor using

K4 100

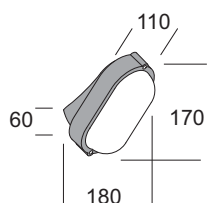

Articolo Item	Colore struttura Structure color				W _{max}	E27	LUMEN	IP	⊕	LUMEN/W	☼
	AT	BI	GR	RU							
E27 K4 100	61307	61301	61306	61308	1x46	E27	700	IP65	⊕	15	A
● Led K4 100 led-W	54747	54741	54746	54748	3,5	led	360	IP65	⊕	103	A
● Led K4 100 led-N	54757	54751	54756	54758	3,5	led	360	IP65	⊕	103	A

K4 200

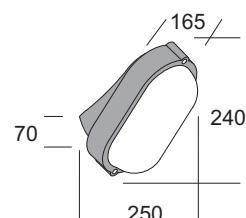

E27 K4 200	61317	61311	61316	61318	1x77	E27	1320	IP65	⊕	17	A
● Led K4 200 led-W	54767	54761	54766	54768	6,3	led	750	IP65	⊕	119	A
● Led K4 200 led-N	54777	54771	54776	54778	6,3	led	750	IP65	⊕	119	A

K8 200

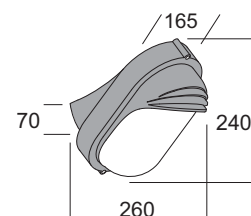

E27 K8 200	61327	61321	61326	61328	1x77	E27	1320	IP65	⊕	17	B
● Led K8 200 led-W	54787	54781	54786	54788	6,3	led	750	IP65	⊕	119	B
● Led K8 200 led-N	54797	54791	54796	54798	6,3	led	750	IP65	⊕	119	B

Colore struttura Structure color

AT RAL 7016
Antracite gofrato *Embossed anthracite*

BI RAL 9016
Bianco gofrato *Embossed white*

GR RAL 9006
Grigio gofrato *Embossed grey*

● **RU**
Ruggine *Rust*

Led Equipaggiata con led 3000K - *Equipped with led 3000K*

Led Equipaggiata con led 4000K - *Equipped with led 4000K*

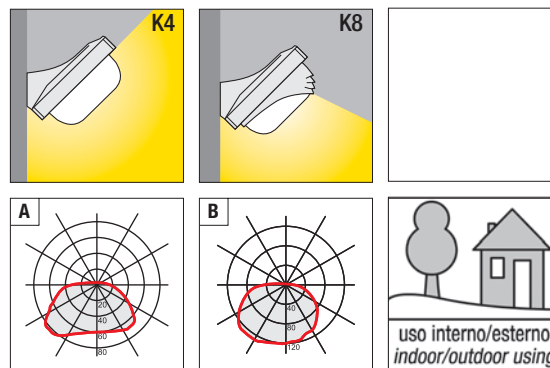

B4 - B8



Lampione da giardino. Diffusore in vetro pressato sabbato internamente. Struttura in pressofusione di alluminio, verniciatura in polvere poliestere con trattamento di fosfatazione. Viti in acciaio inox. Guarnizioni in gomma ai polimeri. Palo in alluminio estruso verniciato in polvere poliestere con trattamento di fosfatazione. Fornito con dispositivo per il collegamento di un cavo di ingresso (alimentazione della rete) e due cavi di uscita (alimentazione degli apparecchi a "cascata" in parallelo). **Versione LED equipaggiata con led smd e alimentatore elettronico incorporato.**

Bollard. Diffuser made in pressed glass with sandblasted inside surface. Structure made in die casting aluminium with polyester paint and phosphate treatment. Inox steel screws. Gasket made in rubber. Extruded aluminium pole polyester painted with phosphate treatment. Equipped with a device for connecting an input cable (mains supply) and two output cables (power to devices in "cascade" in parallel). **LED version equipped with smd led and electronic driver included.**

Borne. Diffuseur en verre pressé sablé à l'intérieur. Structure réalisée en fonte d'aluminium avec vernis polyester et traitement de phosphatation. Vis en acier inox. Joint en gomme. Pilier en extrusion d'aluminium coloré avec vernis polyester et traitement de phosphatation. Equipé d'un dispositif permettant de connecter un câble d'entrée (alimentation secteur) et de deux câbles de sortie (puissance aux dispositifs de la "cascade" en parallèle). **Version LED équipée avec led smd et ballast électronique incorporé.**

Baliza. Difusor de vidrio presado arenado internamente. Estructura en fundición a presión de aluminio con pintura en polvo poliéster y tratamiento de fosfatación. Tornillos de acero inoxidable. Junta de protección de goma. Poste de aluminio extrudido pintado en polvo poliéster con tratamiento de fosfatación. Suministrado con un dispositivo para conectar un cable de entrada (red eléctrica) y dos cables de salida (energía a los dispositivos en "cascada" en paralelo). **Version LED suministrada con led smd y alimentador electrónico incluido.**

Pollerleuchte. Diffusor aus Pressglas, innen sandgestrahlt. Struktur aus Aluminiumdruckguss, Lackierung aus Polyester Pulver mit Phosphatierung. Schrauben aus Edelstahl. Dichtungen aus Polymergummi. Ständer aus Aluminium extrusion. Lackierung aus Polyester Pulver mit Phosphatierung. Ausgestattet mit einer Vorrichtung zum Anschließen einer Eingangsspannung Kabel (Netz) und zwei Output-Kabel (Stromversorgung von Geräten in "Kaskade" parallel). **Ausführung LED zum led smd und integriert Versorgungsgerät elektronisch.**



14 applique interni/esterni
wall lights indoor/outdoor

150 plafoniere interni/esterni
ceiling bowls indoor/outdoor

248 testaletto
bed head units

258 sospensioni
suspensions

344 lampade
lamps

384 lampioni ed incassi
bollards & recessed lights

450 indice
index

Colore struttura Structure color

Articolo Item

AT BI GR RU W_{max} LUMEN LUMEN/W

B4 200

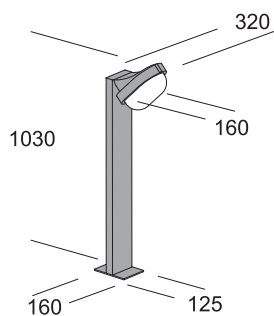

Articolo Item	AT	BI	GR	RU	W _{max}	LUMEN	LUMEN/W
E27 B4 200	61247	61241	61246	61248	1x77	E27 1320	IP65 17 A
Led B4 200 led-W	59207	59201	59206	59208	6,3	led 750	IP65 119 A
Led B4 200 led-N	59217	59211	59216	59218	6,3	led 750	IP65 119 A

B4 200/2

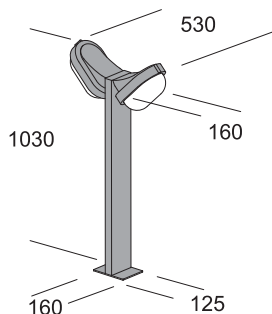

Articolo Item	AT	BI	GR	RU	W _{max}	LUMEN	LUMEN/W
E27 B4 200/2	61257	61251	61256	61258	2x77	E27 2640	IP65 17 A
Led B4 200/2 led-W	59227	59221	59226	59228	12,6	led 1500	IP65 119 A
Led B4 200/2 led-N	59237	59231	59236	59238	12,6	led 1500	IP65 119 A

Colore struttura Structure color

● Nuova versione New version

AT RAL 7016 Antracite gofrato Embossed anthracite	BI RAL 9016 Bianco gofrato Embossed white	GR RAL 9006 Grigio gofrato Embossed grey	● RU Ruggine Rust
--	--	---	----------------------

- Led Equipaggiata con led 3000K - Equipped with led 3000K
- Led Equipaggiata con led 4000K - Equipped with led 4000K

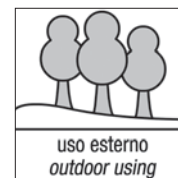
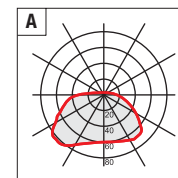
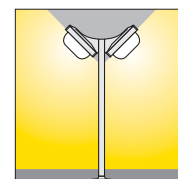
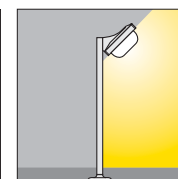
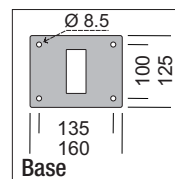

B8 200

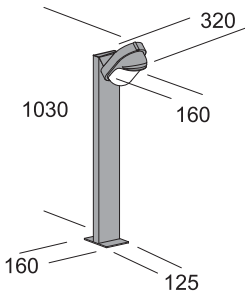

Colore struttura Structure color

Articolo Item

AT BI GR RU
Codice Code

W_{max}



LUMEN



LUMEN/W



E27	B8 200	61267	61261	61266	61268	1x77	E27	1320	IP65	⊕	17	A
Led	B8 200 led-W	59247	59241	59246	59248	6,3	led	750	IP65	⊕	119	A
Led	B8 200 led-N	59257	59251	59256	59258	6,3	led	750	IP65	⊕	119	A

B8 200/2

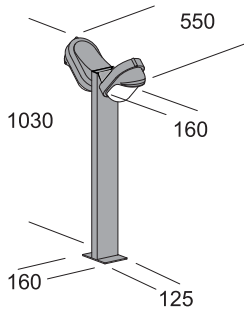

E27	B8 200/2	61277	61271	61276	61278	2x77	E27	2640	IP65	⊕	17	A
Led	B8 200/2 led-W	59267	59261	59266	59268	12,6	led	1500	IP65	⊕	119	A
Led	B8 200/2 led-N	59277	59271	59276	59278	12,6	led	1500	IP65	⊕	119	A

Colore struttura Structure color

● Nuova versione New version

AT RAL 7016
Antracite gofrato Embossed anthracite

BI RAL 9016
Bianco gofrato Embossed white

GR RAL 9006
Grigio gofrato Embossed grey

● RU
Ruggine Rust

Led Equipaggiata con led 3000K - Equipped with led 3000K

Led Equipaggiata con led 4000K - Equipped with led 4000K

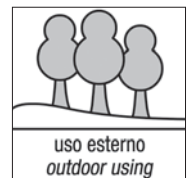
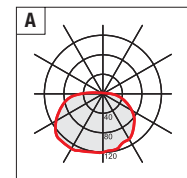
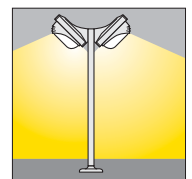
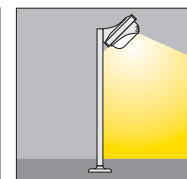
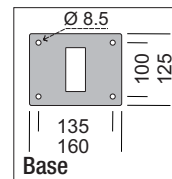

Indice dei codici

012345678

Codes index Index des codes
Indice de los códigos Index der artikelnummern

cod.	articolo/item	pag.	cod.	articolo/item	pag.	cod.	articolo/item	pag.	cod.	articolo/item	pag.
10161	ASTRA 450 EM/64	194	10821	GAMMA 370 EM IP BI	214	14151	GRIFFE 600 EM LED-W BI	223	14442	DISCO 310 EM LED-W GI	233
10171	ASTRA 550 EM/84	195	10822	GAMMA 370 EM IP OR	214	14161	GRIFFE 600 EM LED-N BI	223	14443	DISCO 310 EM LED-W RO	233
10231	GAMMA 450 EM/64	211	10830	GAMMA 470 EM IP CR	215	14171	GRIFFE 600 EM BI	223	14445	DISCO 310 EM LED-W BL	233
10261	TOP PLUS EM TR	185	10831	GAMMA 470 EM IP BI	215	14181	GRIFFE 600 RGB DIG BI	223	14450	DISCO 310 EM LED-N TR	233
10262	TOP PLUS EM GI	185	10832	GAMMA 470 EM IP OR	215	14191	GRIFFE 600 RGB DALI BI	223	14452	DISCO 310 EM LED-N GI	233
10263	TOP PLUS EM RO	185	10860	MEGA 460 EM IP CR	207	14200	ASTRA 300 EM LED-W TR	192	14453	DISCO 310 EM LED-N RO 5	233
10265	TOP PLUS EM BL	185	10869	MEGA 460 EM IP AL	207	14202	ASTRA 300 EM LED-W GI	192	14455	DISCO 310 EM LED-N BL	233
10351	VIP 500 EM CR	167	10871	OMEGA 400 EM BI	239	14203	ASTRA 300 EM LED-W RO	192	14460	GAMMA 350 EM LED-W TR	210
10356	VIP 500 EM NS	167	10876	OMEGA 400 EM CR	239	14205	ASTRA 300 EM LED-W BL	192	14462	GAMMA 350 EM LED-W GI	210
10440	ASTRA 300 EM IP TR	192	10877	OMEGA 400 EM NE	239	14210	ASTRA 300 EM LED-N TR	192	14463	GAMMA 350 EM LED-W RO	210
10442	ASTRA 300 EM IP GI	192	10881	OMEGA 500 EM BI	239	14212	ASTRA 300 EM LED-N GI	192	14465	GAMMA 350 EM LED-W BL	210
10443	ASTRA 300 EM IP RO	192	10886	OMEGA 500 EM CR	239	14213	ASTRA 300 EM LED-N RO	192	14470	GAMMA 350 EM LED-N TR	210
10445	ASTRA 300 EM IP BL	192	10887	OMEGA 500 EM NE	239	14215	ASTRA 300 EM LED-N BL	192	14472	GAMMA 350 EM LED-N GI	210
10451	ASTRA 300 EM/26	192	10920	YOYO P600 DM RGB DIG CR	163	14220	ASTRA 360 EM LED-W TR	193	14473	GAMMA 350 EM LED-N RO	210
10460	ASTRA 360 EM IP TR	193	10921	YOYO P600 DM RGB DIG BI	163	14222	ASTRA 360 EM LED-W GI	193	14475	GAMMA 350 EM LED-N BL	210
10462	ASTRA 360 EM IP GI	193	10930	YOYO P600 DM RGB DALI CR	163	14223	ASTRA 360 EM LED-W RO	193	14480	GAMMA 450 EM LED-W TR	211
10463	ASTRA 360 EM IP RO	193	10931	YOYO P600 DM RGB DALI BI	163	14225	ASTRA 360 EM LED-W BL	193	14482	GAMMA 450 EM LED-W GI	211
10465	ASTRA 360 EM IP BL	193	10940	YOYO P900 DM RGB DIG CR	163	14230	ASTRA 360 EM LED-N TR	193	14483	GAMMA 450 EM LED-W RO	211
10471	ASTRA 360 EM/36	193	10941	YOYO P900 DM RGB DIG BI	163	14232	ASTRA 360 EM LED-N GI	193	14485	GAMMA 450 EM LED-W BL	211
10480	ASTRA 450 EM IP TR	194	10950	YOYO P900 DM RGB DALI CR	163	14233	ASTRA 360 EM LED-N RO	193	14490	GAMMA 450 EM LED-N TR	211
10482	ASTRA 450 EM IP GI	194	10951	YOYO P900 DM RGB DALI BI	163	14235	ASTRA 360 EM LED-N BL	193	14492	GAMMA 450 EM LED-N GI	211
10483	ASTRA 450 EM IP RO	194	10961	LELLA 300 EM BI	241	14240	ASTRA 450 EM LED-W TR	194	14493	GAMMA 450 EM LED-N RO	211
10485	ASTRA 450 EM IP BL	194	10968	LELLA 300 EM RU	241	14242	ASTRA 450 EM LED-W GI	194	14495	GAMMA 450 EM LED-N BL	211
10490	ASTRA 550 EM IP TR	195	10969	LELLA 300 EM AL	241	14243	ASTRA 450 EM LED-W RO	194	14500	GAMMA 370 EM LED-W CR	214
10492	ASTRA 550 EM IP GI	195	11091	ALMA 400 BI	226	14245	ASTRA 450 EM LED-W BL	194	14501	GAMMA 370 EM LED-W BI	214
10493	ASTRA 550 EM IP RO	195	11101	ALMA 600 BI	227	14250	ASTRA 450 EM LED-N TR	194	14502	GAMMA 370 EM LED-W OR	214
10495	ASTRA 550 EM IP BL	195	11111	GRIFFE 400 BI	222	14252	ASTRA 450 EM LED-N GI	194	14510	GAMMA 370 EM LED-N CR	214
10500	GAMMA 350 EM IP TR	210	11121	GRIFFE 600 BI	223	14253	ASTRA 450 EM LED-N RO	194	14511	GAMMA 370 EM LED-N BI	214
10502	GAMMA 350 EM IP GI	210	11131	REGOLO 250	229	14255	ASTRA 450 EM LED-N BL	194	14512	GAMMA 370 EM LED-N OR	214
10503	GAMMA 350 EM IP RO	210	11141	REGOLO 350	229	14260	ASTRA 550 EM LED-W TR	195	14520	GAMMA 470 EM LED-W CR	215
10505	GAMMA 350 EM IP BL	210	11151	TUTTOTONDO P600 BI	156	14262	ASTRA 550 EM LED-W GI	195	14521	GAMMA 470 EM LED-W BI	215
10511	GAMMA 350 EM/36	210	11156	TUTTOTONDO P600 AL	156	14263	ASTRA 550 EM LED-W RO	195	14522	GAMMA 470 EM LED-W OR	215
10520	GAMMA 450 EM IP TR	211	11157	TUTTOTONDO P600 NE	156	14265	ASTRA 550 EM LED-W BL	195	14530	GAMMA 470 EM LED-N CR	215
10522	GAMMA 450 EM IP GI	211	11161	TUTTOTONDO P900 BI	156	14270	ASTRA 550 EM LED-N TR	195	14531	GAMMA 470 EM LED-N BI	215
10523	GAMMA 450 EM IP RO	211	11166	TUTTOTONDO P900 AL	156	14272	ASTRA 550 EM LED-N GI	195	14532	GAMMA 470 EM LED-N OR	215
10525	GAMMA 450 EM IP BL	211	11167	TUTTOTONDO P900 NE	156	14273	ASTRA 550 EM LED-N RO	195	14541	LELLA 300S EM LED-W BI	241
10530	MEGA 450 EM IP TR	205	11401	OMEGA 300 BI	239	14275	ASTRA 550 EM LED-N BL	195	14548	LELLA 300S EM LED-W RU	241
10532	MEGA 450 EM IP GI	205	11406	OMEGA 300 CR	239	14280	ASTRA 320 EM LED-W CR	198	14549	LELLA 300S EM LED-W AL	241
10533	MEGA 450 EM IP RO	205	11407	OMEGA 300 NE	239	14287	ASTRA 320 EM LED-W NE	198	14551	LELLA 300S EM LED-N BI	241
10535	MEGA 450 EM IP BL	205	11411	OMEGA 400 BI	239	14289	ASTRA 320 EM LED-W AL	198	14558	LELLA 300S EM LED-N RU	241
10541	MEGA 450 EM/36	205	11416	OMEGA 400 CR	239	14290	ASTRA 320 EM LED-N CR	198	14559	LELLA 300S EM LED-N TR	241
10550	DISCO 310 EM IP TR	233	11417	OMEGA 400 NE	239	14297	ASTRA 320 EM LED-N NE	198	14600	MEGA 450 EM LED-W AL	205
10552	DISCO 310 EM IP GI	233	11421	OMEGA 500 BI	239	14299	ASTRA 320 EM LED-N AL	198	14602	MEGA 450 EM LED-W GI	205
10553	DISCO 310 EM IP RO	233	11426	OMEGA 500 CR	239	14300	ASTRA 370 EM LED-W CR	198	14603	MEGA 450 EM LED-W RO	205
10555	DISCO 310 EM IP BL	233	11427	OMEGA 500 NE	239	14307	ASTRA 370 EM LED-W NE	198	14605	MEGA 450 EM LED-W BL	205
10560	DISCO 310 EM/26	233	11801	LELLA 250 BI	241	14309	ASTRA 370 EM LED-W AL	198	14610	MEGA 450 EM LED-N TR	205
10570	QUADRO 300 EM IP TR	231	11808	LELLA 250 RU	241	14310	ASTRA 370 EM LED-N CR	198	14612	MEGA 450 EM LED-N GI	205
10572	QUADRO 300 EM IP GI	231	11809	LELLA 250 AL	241	14317	ASTRA 370 EM LED-N NE	198	14613	MEGA 450 EM LED-N RO	205
10573	QUADRO 300 EM IP RO	231	11811	LELLA 300 BI	241	14319	ASTRA 370 EM LED-N AL	198	14615	MEGA 450 EM LED-N BL	205
10575	QUADRO 300 EM IP BL	231	11818	LELLA 300 RU	241	14320	ASTRA 470 EM LED-W CR	199	14620	MEGA 460 EM LED-W CR	207
10580	QUADRO 300 EM/26	231	11819	LELLA 300 AL	241	14327	ASTRA 470 EM LED-W NE	199	14629	MEGA 460 EM LED-W AL	207
10660	MEGA 460 EM/36 CR	207	12250	YOYO P600 CR	161	14329	ASTRA 470 EM LED-W BL	199	14630	MEGA 460 EM LED-W CR	207
10669	MEGA 460 EM/36 AL	207	12251	YOYO P600 BI	161	14330	ASTRA 470 EM LED-N CR	199	14639	MEGA 460 EM LED-N AL	207
10691	BOLLA 370 EM/36	237	12260	YOYO P900 CR	161	14337	ASTRA 470 EM LED-N NE	199	14641	OMEGA 400 EM LED-W BI	239
10700	YOYO P600 EM CR	161	12261	YOYO P900 BI	161	14339	ASTRA 470 EM LED-N AL	199	14646	OMEGA 400 EM LED-W CR	239
10701	YOYO P600 EM BI	161	13451	TOP PLUS TR	185	14340	ASTRA 570 EM LED-W CR	199	14647	OMEGA 400 EM LED-W NE	239
10710	YOYO P900 EM CR	161	13452	TOP PLUS GI	185	14347	ASTRA 570 EM LED-W NE	199	14651	OMEGA 400 EM LED-N BI	239
10711	YOYO P900 EM BI	161	13453	TOP PLUS RO	185	14349	ASTRA 570 EM LED-W AL	199	14656	OMEGA 400 EM LED-N CR	239
10720	ASTRA 320 EM IP CR	198	13455	TOP PLUS BL	185	14350	ASTRA 570 EM LED-N CR	199	14657	OMEGA 400 EM LED-N NE	239
10727	ASTRA 320 EM IP NE	198	13510	COSMO P300 TR	165	14357	ASTRA 570 EM LED-N NE	199	14661	OMEGA 500 EM LED-W BI	239
10729	ASTRA 320 EM IP AL	198	13512	COSMO P300 GI	165	14359	ASTRA 570 EM LED-N AL	199	14666	OMEGA 500 EM LED-W CR	239
10730	ASTRA 370 EM IP CR	198	13513	COSMO P300 RO	165	14360	BETA EM LED-W CR	217	14667	OMEGA 500 EM LED-W NE	239
10737	ASTRA 370 EM IP NE	198	13515	COSMO P300 BL	165	14361	BETA EM LED-W BI	217	14671	OMEGA 500 EM LED-N BI	239
10739	ASTRA 370 EM IP AL	198	13520	COSMO P400 TR	165	14366	BETA EM LED-W GR	217	14676	OMEGA 500 EM LED-N CR	239
10740	ASTRA 470 EM IP CR	199	13522	COSMO P400 GI	165	14367	BETA EM LED-W AT	217	14677	OMEGA 500 EM LED-N NE	239
10747	ASTRA 470 EM IP NE	199	13523	COSMO P400 RO	165	14370	BETA EM LED-N CR	217	14680	QUADRO 300 EM LED-W TR	231
10749	ASTRA 470 EM IP AL	199	13525	COSMO P400 BL	165	14371	BETA EM LED-N BI	217	14682	QUADRO 300 EM LED-W GI	231
10750	ASTRA 570 EM IP CR	199	14001	ALMA 400 EM LED-W BI	226	14376	BETA EM LED-N GR	217	14683	QUADRO 300 EM LED-W RO	231
10757	ASTRA 570 EM IP NE	199	14011	ALMA 400 EM LED-N BI	226	14377	BETA EM LED-N AT	217	14685	QUADRO 300 EM LED-W BL	231
10759	ASTRA 570 EM IP AL	199	14021	ALMA 400 EM BI	226	14380	BOLLA 310 EM LED-W TR	236	14690	QUADRO 300 EM LED-N TR	231
10760	BETA EM CR	217	14031	ALMA 400 RGB DIG BI	226	14390	BOLLA 310 EM LED-N TR	236	14692	QUADRO 300 EM LED-N GI	231
10761	BETA EM BI	217	14041	ALMA 400 RGB DALI BI	226	14400	BOLLA 370 EM LED-W TR	237	14693	QUADRO 300 EM LED-N RO	231
10766	BETA EM GR	217	14051	ALMA 600 EM LED-W BI	227	14410	BOLLA 370 EM LED-N TR	237	14695	QUADRO 300 EM LED-N BL	231
10767	BETA EM AT	217	14061	ALMA 600 EM LED-N BI	227	14420	DELTA EM LED-W CR	219	14701	REGOLO 350 EM LED-W	229
10770	BOLLA 310 EM IP TR	236	14071	ALMA 600 EM BI	227	14421	DELTA EM LED-W BI	219	14711	REGOLO 350 EM LED-N	229
10781	BOLLA 310 EM/26	236	14081	ALMA 600 RGB DIG BI	227	14426	DELTA EM LED-W GR	219	14721	TOP PLUS EM LED-W TR	185
10790	BOLLA 370 EM IP TR	237	14091	ALMA 600 RGB DALI BI	227	14427	DELTA EM LED-W AT	219	14722	TOP PLUS EM LED-W GI	185
10810	DELTA EM CR	219	14101	GRIFFE 400 EM LED-W BI	222	14430	DELTA EM LED-N CR	219	14723	TOP PLUS EM LED-W RO	185
10811	DELTA EM BI	219	14111	GRIFFE 400 EM LED-N BI	222	14431	DELTA EM LED-N BI	219	14725	TOP PLUS EM LED-W BL	185
10816	DELTA EM GR	219	14121	GRIFFE 400 EM BI	222	14436	DELTA EM LED-N GR	219	14731	TOP PLUS EM LED-N TR	185
10817	DELTA EM AT	219	14131	GRIFFE 400 RGB DIG BI	222	14437	DELTA EM LED-N AT	219	14732	TOP PLUS EM LED-N GI	185
10820	GAMMA 370 EM IP CR	214	14141	GRIFFE 400 RGB DALI BI	222	14440	DISCO 310 EM LED-W TR	233	14733	TOP PLUS EM LED-N RO	185

cod.	articolo/item	pag.	cod.	articolo/item	pag.	cod.	articolo/item	pag.	cod.	articolo/item	pag.
14735	TOP PLUS EM LED-N BL	185	15133	MEGA 350 LED-N RO	204	15432	QUADRO 250 LED24-N GI	231	15760	YOYO P600 LED-W CR	161
14741	TUTTOTONDO P600 EM LED-W BI	156	15135	MEGA 350 LED-N BL	204	15433	QUADRO 250 LED24-N RO	231	15761	YOYO P600 LED-W BI	161
14746	TUTTOTONDO P600 EM LED-W AL	156	15140	MEGA 350 LED24-W TR	204	15435	QUADRO 250 LED24-N BL	231	15770	YOYO P600 LED-N CR	161
14747	TUTTOTONDO P600 EM LED-W NE	156	15142	MEGA 350 LED24-W GI	204	15440	QUADRO 250 DM LED-W TR	231	15771	YOYO P600 LED-N BI	161
14751	TUTTOTONDO P600 EM LED-N BI	156	15143	MEGA 350 LED24-W RO	204	15442	QUADRO 250 DM LED-W GI	231	15780	YOYO P600 DM LED-W CR	161
14756	TUTTOTONDO P600 EM LED-N AL	156	15145	MEGA 350 LED24-W BL	204	15443	QUADRO 250 DM LED-W RO	231	15781	YOYO P600 DM LED-W BI	161
14757	TUTTOTONDO P600 EM LED-N NE	156	15150	MEGA 350 LED24-N TR	204	15445	QUADRO 250 DM LED-W BL	231	15790	YOYO P600 DM LED-N CR	161
14761	TUTTOTONDO P900 EM LED-W BI	156	15152	MEGA 350 LED24-N GI	204	15450	QUADRO 250 DM LED-N TR	231	15791	YOYO P600 DM LED-N BI	161
14766	TUTTOTONDO P900 EM LED-W AL	156	15153	MEGA 350 LED24-N RO	204	15452	QUADRO 250 DM LED-N GI	231	15800	YOYO P600 LED-W RGB DIG CR	163
14767	TUTTOTONDO P900 EM LED-W NE	156	15155	MEGA 350 LED24-N BL	204	15453	QUADRO 250 DM LED-N RO	231	15801	YOYO P600 LED-W RGB DIG BI	163
14771	TUTTOTONDO P900 EM LED-N BI	156	15160	MEGA 350 DM LED-W TR	204	15455	QUADRO 250 DM LED-N BL	231	15810	YOYO P600 LED-N RGB DIG CR	163
14776	TUTTOTONDO P900 EM LED-N AL	156	15162	MEGA 350 DM LED-W GI	204	15460	QUADRO 300 LED-W TR	231	15811	YOYO P600 LED-N RGB DIG BI	163
14777	TUTTOTONDO P900 EM LED-N NE	156	15163	MEGA 350 DM LED-W RO	204	15462	QUADRO 300 LED-W GI	231	15820	YOYO P600 LED-W RGB DALI CR	163
14781	TUTTOTONDO P600 EM BI	156	15165	MEGA 350 DM LED-W BL	204	15463	QUADRO 300 LED-W RO	231	15821	YOYO P600 LED-W RGB DALI BI	163
14786	TUTTOTONDO P600 EM AL	156	15170	MEGA 350 DM LED-N TR	204	15465	QUADRO 300 LED-W BL	231	15830	YOYO P600 LED-N RGB DALI CR	163
14787	TUTTOTONDO P600 EM NE	156	15172	MEGA 350 DM LED-N GI	204	15470	QUADRO 300 LED-N TR	231	15831	YOYO P600 LED-N RGB DALI BI	163
14791	TUTTOTONDO P600 DM RGB DIG BI	159	15173	MEGA 350 DM LED-N RO	204	15472	QUADRO 300 LED-N GI	231	15840	YOYO P900 LED-W CR	161
14796	TUTTOTONDO P600 DM RGB DIG AL	159	15175	MEGA 350 DM LED-N BL	204	15473	QUADRO 300 LED-N RO	231	15841	YOYO P900 LED-W BI	161
14797	TUTTOTONDO P600 DM RGB DIG NE	159	15180	MEGA 450 LED-W TR	205	15475	QUADRO 300 LED-N BL	231	15850	YOYO P900 LED-N CR	161
14801	TUTTOTONDO P600 DM RGB DALI BI	159	15182	MEGA 450 LED-W GI	205	15480	QUADRO 300 LED24-W TR	231	15851	YOYO P900 LED-N BI	161
14806	TUTTOTONDO P600 DM RGB DALI AL	159	15183	MEGA 450 LED-W RO	205	15482	QUADRO 300 LED24-W GI	231	15860	YOYO P900 DM LED-W CR	161
14807	TUTTOTONDO P600 DM RGB DALI NE	159	15185	MEGA 450 LED-W BL	205	15483	QUADRO 300 LED24-W RO	231	15861	YOYO P900 DM LED-W BI	161
14811	TUTTOTONDO P900 EM BI	156	15190	MEGA 450 LED-N TR	205	15485	QUADRO 300 LED24-W BL	231	15870	YOYO P900 DM LED-N CR	161
14816	TUTTOTONDO P900 EM AL	156	15192	MEGA 450 LED-N GI	205	15490	QUADRO 300 LED24-N TR	231	15871	YOYO P900 DM LED-N BI	161
14817	TUTTOTONDO P900 EM NE	156	15193	MEGA 450 LED-N RO	205	15492	QUADRO 300 LED24-N GI	231	15880	YOYO P900 LED-W RGB DIG CR	163
14821	TUTTOTONDO P900 DM RGB DIG BI	159	15195	MEGA 450 LED-N BL	205	15493	QUADRO 300 LED24-N RO	231	15881	YOYO P900 LED-W RGB DIG BI	163
14826	TUTTOTONDO P900 DM RGB DIG AL	159	15200	MEGA 450 DM LED-W TR	205	15495	QUADRO 300 LED24-N BL	231	15890	YOYO P900 LED-N RGB DIG CR	163
14827	TUTTOTONDO P900 DM RGB DIG NE	159	15202	MEGA 450 DM LED-W GI	205	15500	QUADRO 300 DM LED-W TR	231	15891	YOYO P900 LED-N RGB DIG BI	163
14831	TUTTOTONDO P900 DM RGB DALI BI	159	15203	MEGA 450 DM LED-W RO	205	15502	QUADRO 300 DM LED-W GI	231	15900	YOYO P900 LED-W RGB DALI CR	163
14836	TUTTOTONDO P900 DM RGB DALI AL	159	15205	MEGA 450 DM LED-W BL	205	15503	QUADRO 300 DM LED-W RO	231	15901	YOYO P900 LED-W RGB DALI BI	163
14837	TUTTOTONDO P900 DM RGB DALI NE	159	15210	MEGA 450 DM LED-N TR	205	15505	QUADRO 300 DM LED-W BL	231	15910	YOYO P900 LED-N RGB DALI CR	163
14841	VIP 500 EM LED-W CR	167	15212	MEGA 450 DM LED-N GI	205	15510	QUADRO 300 DM LED-N TR	231	15911	YOYO P900 LED-N RGB DALI BI	163
14846	VIP 500 EM LED-W NS	167	15213	MEGA 450 DM LED-N RO	205	15512	QUADRO 300 DM LED-N GI	231	15920	COSMO P300 LED-W TR	165
14851	VIP 500 EM LED-N CR	167	15215	MEGA 450 DM LED-N BL	205	15513	QUADRO 300 DM LED-N RO	231	15922	COSMO P300 LED-W GI	165
14856	VIP 500 EM LED-N NS	167	15220	MEGA 260 LED-W CR	207	15515	QUADRO 300 DM LED-N BL	231	15923	COSMO P300 LED-W RO	165
14861	VIP 501 EM LED-W CR	167	15229	MEGA 260 LED-W AL	207	15521	REGOLO 250 LED-W	229	15925	COSMO P300 LED-W BL	165
14866	VIP 501 EM LED-W NS	167	15230	MEGA 260 LED-N CR	207	15531	REGOLO 250 LED-N	229	15930	COSMO P300 LED-N TR	165
14871	VIP 501 EM LED-N CR	167	15239	MEGA 260 LED-N AL	207	15541	REGOLO 350 LED-W	229	15932	COSMO P300 LED-N GI	165
14876	VIP 501 EM LED-N NS	167	15240	MEGA 260 DM LED-W CR	207	15551	REGOLO 350 LED-N	229	15933	COSMO P300 LED-N RO	165
14880	YOYO P600 EM LED-W CR	161	15249	MEGA 260 DM LED-W AL	207	15561	REGOLO 350 DM LED-W	229	15935	COSMO P300 LED-N BL	165
14881	YOYO P600 EM LED-W BI	161	15250	MEGA 260 DM LED-N CR	207	15571	REGOLO 350 DM LED-N	229	15940	COSMO P400 LED-W TR	165
14890	YOYO P600 EM LED-N CR	161	15259	MEGA 260 DM LED-N AL	207	15581	TOP PLUS DM LED-W TR	185	15942	COSMO P400 LED-W GI	165
14891	YOYO P600 EM LED-N BI	161	15260	MEGA 360 LED-W CR	207	15582	TOP PLUS DM LED-W GI	185	15943	COSMO P400 LED-W RO	165
14900	YOYO P900 EM LED-W CR	161	15269	MEGA 360 LED-W AL	207	15583	TOP PLUS DM LED-W RO	185	15945	COSMO P400 LED-W BL	165
14901	YOYO P900 EM LED-W BI	161	15270	MEGA 360 LED-N CR	207	15585	TOP PLUS DM LED-W BL	185	15950	COSMO P400 LED-N TR	165
14910	YOYO P900 EM LED-N CR	161	15279	MEGA 360 LED-N AL	207	15591	TOP PLUS DM LED-N TR	185	15952	COSMO P400 LED-N GI	165
14911	YOYO P900 EM LED-N BI	161	15280	MEGA 360 DM LED-W CR	207	15592	TOP PLUS DM LED-N GI	185	15953	COSMO P400 LED-N RO	165
15001	LELLA 250 LED-W BI	241	15289	MEGA 360 DM LED-W AL	207	15593	TOP PLUS DM LED-N RO	185	15955	COSMO P400 LED-N BL	165
15008	LELLA 250 LED-W RU	241	15290	MEGA 360 DM LED-N CR	207	15595	TOP PLUS DM LED-N BL	185	15981	VOG P-W BI	180
15009	LELLA 250 LED-W AL	241	15299	MEGA 360 DM LED-N AL	207	15601	TUTTOTONDO P600 LED-W BI	156	15989	VOG P-W AL	180
15011	LELLA 250 LED-N BI	241	15300	MEGA 460 LED-W CR	207	15606	TUTTOTONDO P600 LED-W AL	156	15991	VOG P-N BI	180
15018	LELLA 250 LED-N RU	241	15309	MEGA 460 LED-W AL	207	15607	TUTTOTONDO P600 LED-W NE	156	15999	VOG P-N AL	180
15019	LELLA 250 LED-N AL	241	15310	MEGA 460 LED-N CR	207	15611	TUTTOTONDO P600 LED-N BI	156	16611	LELLA 250S LED-W BI	241
15021	LELLA 300 LED-W BI	241	15319	MEGA 460 LED-N AL	207	15616	TUTTOTONDO P600 LED-N AL	156	16618	LELLA 250S LED-W RU	241
15028	LELLA 300 LED-W RU	241	15320	MEGA 460 DM LED-W CR	207	15617	TUTTOTONDO P600 LED-N NE	156	16619	LELLA 250S LED-W AL	241
15029	LELLA 300 LED-W AL	241	15329	MEGA 460 DM LED-W AL	207	15621	TUTTOTONDO P600 DM LED-W BI	156	16621	LELLA 250S LED-N BI	241
15031	LELLA 300 LED-N BI	241	15330	MEGA 460 DM LED-N CR	207	15626	TUTTOTONDO P600 DM LED-W AL	156	16628	LELLA 250S LED-N RU	241
15038	LELLA 300 LED-N RU	241	15339	MEGA 460 DM LED-N AL	207	15627	TUTTOTONDO P600 DM LED-W NE	156	16629	LELLA 250S LED-N AL	241
15039	LELLA 300 LED-N AL	241	15341	OMEGA 300 LED-W BI	239	15631	TUTTOTONDO P600 DM LED-N BI	156	16651	ALMA 400 LED-W BI	226
15060	MEGA 250 LED-W TR	204	15346	OMEGA 300 LED-W CR	239	15636	TUTTOTONDO P600 DM LED-N AL	156	16661	ALMA 400 LED-N BI	226
15062	MEGA 250 LED-W GI	204	15347	OMEGA 300 LED-W NE	239	15637	TUTTOTONDO P600 DM LED-N NE	156	16671	ALMA 400 DM LED-W BI	226
15063	MEGA 250 LED-W RO	204	15351	OMEGA 300 LED-N BI	239	15641	TUTTOTONDO P900 LED-W BI	156	16681	ALMA 400 DM LED-N BI	226
15065	MEGA 250 LED-W BL	204	15356	OMEGA 300 LED-N CR	239	15646	TUTTOTONDO P900 LED-W AL	156	16691	ALMA 600 LED-W BI	227
15070	MEGA 250 LED-N TR	204	15357	OMEGA 300 LED-N NE	239	15647	TUTTOTONDO P900 LED-W NE	156	16701	ALMA 600 LED-W BI	227
15072	MEGA 250 LED-N GI	204	15361	OMEGA 400 LED-W BI	239	15651	TUTTOTONDO P900 LED-N BI	156	16711	ALMA 600 DM LED-N BI	227
15073	MEGA 250 LED-N RO	204	15366	OMEGA 400 LED-W CR	239	15656	TUTTOTONDO P900 LED-N AL	156	16721	ALMA 600 DM LED-N BI	227
15075	MEGA 250 LED-N BL	204	15367	OMEGA 400 LED-W NE	239	15657	TUTTOTONDO P900 LED-N NE	156	16731	LELLA 300S LED-W BI	241
15080	MEGA 250 LED24-W TR	204	15371	OMEGA 400 LED-N BI	239	15661	TUTTOTONDO P900 DM LED-W BI	156	16738	LELLA 300S LED-W RU	241
15082	MEGA 250 LED24-W GI	204	15376	OMEGA 400 LED-N CR	239	15666	TUTTOTONDO P900 DM LED-W AL	156	16739	LELLA 300S LED-W AL	241
15083	MEGA 250 LED24-W RO	204	15377	OMEGA 400 LED-N NE	239	15667	TUTTOTONDO P900 DM LED-W NE	156	16741	LELLA 300S LED-N BI	241
15085	MEGA 250 LED24-W BL	204	15381	OMEGA 500 LED-W BI	239	15671	TUTTOTONDO P900 DM LED-N BI	156	16748	LELLA 300S LED-N RU	241
15090	MEGA 250 LED24-N TR	204	15386	OMEGA 500 LED-W CR	239	15676	TUTTOTONDO P900 DM LED-N AL	156	16749	LELLA 300S LED-N AL	241
15092	MEGA 250 LED24-N GI	204	15387	OMEGA 500 LED-W NE	239	15677	TUTTOTONDO P900 DM LED-N NE	156	16781	TOP PLUS LED-W TR	185
15093	MEGA 250 LED24-N RO	204	15391	OMEGA 500 LED-N BI	239	15681	VIP 500 LED-W CR	167	16782	TOP PLUS LED-W GI	185
15095	MEGA 250 LED24-N BL	204	15396	OMEGA 500 LED-N CR	239	15686	VIP 500 LED-W NS	167	16783	TOP PLUS LED-W RO	185
15100	MEGA 250 DM LED-W	204	15397	OMEGA 500 LED-N NE	239	15691	VIP 500 LED-N CR	167	16785	TOP PLUS LED-W BL	185
15102	MEGA 250 DM LED-W GI	204	15400	QUADRO 250 LED-W TR	231	15696	VIP 500 LED-N NS	167	16791	TOP PLUS LED-N TR	185
15103	MEGA 250 DM LED-W RO	204	15402	QUADRO 250 LED-W GI	231	15701	VIP 500 DM LED-W CR	167	16792	TOP PLUS LED-N GI	185
15105	MEGA 250 DM LED-W BL	204	15403	QUADRO 250 LED-W RO	231	15706	VIP 500 DM LED-W NS	167	16793	TOP PLUS LED-N RO	185
15110	MEGA 250 DM LED-N TR	204	15405	QUADRO 250 LED-W BL	231	15711	VIP 500 DM LED-N CR	167	16795	TOP PLUS LED-N BL	185
15112	MEGA 250 DM LED-N GI	204	15410	QUADRO 250 LED-N TR	231	15716	VIP 500 DM LED-N NS	167	16821	GRIFFE 400 LED-W BI	222
15113	MEGA 250 DM LED-N RO	204	15412	QUADRO 250 LED-N GI	231	15721	VIP 501 LED-W CR	167	16831	GRIFFE 400 LED-N BI	222
15115	MEGA 250 DM LED-N BL	204	15413	QUADRO 250 LED-N RO	231	15726	VIP 501 LED-W NS	167	16841	GRIFFE 400 DM LED-W BI	222
15120	MEGA 350 LED-W TR	204	15415	QUADRO 250 LED-N BL	231	15731	VIP 501 LED-N CR	167	16851	GRIFFE 400 DM LED-N BI	222
15122	MEGA 350 LED-W GI	204	15420	QUADRO 250 LED24-W TR	231	15736	VIP 501 LED-N NS	167	16861	GRIFFE 600 LED-W BI	223
15123	MEGA 350 LED-W RO	204	15422	QUADRO 250 LED24-W GI	231	15741	VIP 501 DM LED-W CR	167	16871	GRIFFE 600 LED-N BI	223
15125	MEGA 350 LED-W BL	204	15423	QUADRO 250 LED24-W RO	231	15746	VIP 501 DM LED-W NS	167	16881	GRIFFE 600 DM LED-W BI	223
15130	MEGA 350 LED-N TR	204	15425	QUADRO 250 LED24-W BL	231	15751	VIP 501 DM LED-N CR	167	16891	GRIFFE 600 DM LED-N BI	223
15132	MEGA 350 LED-N GI	204	15430	QUADRO 250 LED24-N TR	231	15756	VIP 501 DM LED-N NS	167	16900	ASTRA 250	

cod.	articolo/item	pag.	cod.	articolo/item	pag.	cod.	articolo/item	pag.	cod.	articolo/item	pag.
16902	ASTRA 250 LED-W GI	192	17123	ASTRA 550 LED-W RO	195	17470	BOLLA 310 DM LED-N TR	236	17743	GAMMA 250 DM LED-W RO	210
16903	ASTRA 250 LED-W RO	192	17125	ASTRA 550 LED-W BL	195	17480	BOLLA 370 LED-W TR	237	17745	GAMMA 250 DM LED-W BL	210
16905	ASTRA 250 LED-W BL	192	17130	ASTRA 550 LED-N TR	195	17490	BOLLA 370 LED-N TR	237	17750	GAMMA 250 DM LED-N TR	210
16910	ASTRA 250 LED-N TR	192	17132	ASTRA 550 LED-N GI	195	17500	BOLLA 370 LED24-W TR	237	17752	GAMMA 250 DM LED-N GI	210
16912	ASTRA 250 LED-N GI	192	17133	ASTRA 550 LED-N RO	195	17510	BOLLA 370 LED24-N TR	237	17753	GAMMA 250 DM LED-N RO	210
16913	ASTRA 250 LED-N RO	192	17135	ASTRA 550 LED-N BL	195	17520	BOLLA 370 DM LED-W TR	237	17755	GAMMA 250 DM LED-N BL	210
16915	ASTRA 250 LED-N BL	192	17140	ASTRA 550 DM LED-W TR	195	17530	BOLLA 370 DM LED-N TR	237	17760	GAMMA 350 LED-W TR	210
16920	ASTRA 250 LED24-W TR	192	17142	ASTRA 550 DM LED-W GI	195	17540	DELTA LED-W CR	219	17762	GAMMA 350 LED-W GI	210
16922	ASTRA 250 LED24-W GI	192	17143	ASTRA 550 DM LED-W RO	195	17541	DELTA LED-W BI	219	17763	GAMMA 350 LED-W RO	210
16923	ASTRA 250 LED24-W RO	192	17145	ASTRA 550 DM LED-W BL	195	17546	DELTA LED-W GR	219	17765	GAMMA 350 LED-W BL	210
16925	ASTRA 250 LED24-W BL	192	17150	ASTRA 550 DM LED-N TR	195	17547	DELTA LED-W AT	219	17770	GAMMA 350 LED-N TR	210
16930	ASTRA 250 LED24-N TR	192	17152	ASTRA 550 DM LED-N GI	195	17550	DELTA LED-N CR	219	17772	GAMMA 350 LED-N GI	210
16932	ASTRA 250 LED24-N GI	192	17153	ASTRA 550 DM LED-N RO	195	17551	DELTA LED-N BI	219	17773	GAMMA 350 LED-N RO	210
16933	ASTRA 250 LED24-N RO	192	17155	ASTRA 550 DM LED-N BL	195	17556	DELTA LED-N GR	219	17775	GAMMA 350 LED-N BL	210
16935	ASTRA 250 LED24-N BL	192	17160	ASTRA 320 LED-W CR	198	17557	DELTA LED-N AT	219	17780	GAMMA 350 LED24-W TR	210
16940	ASTRA 250 DM LED-W TR	192	17167	ASTRA 320 LED-W NE	198	17560	DELTA DM LED-W CR	219	17782	GAMMA 350 LED24-W GI	210
16942	ASTRA 250 DM LED-W GI	192	17169	ASTRA 320 LED-W AL	198	17561	DELTA DM LED-W BI	219	17783	GAMMA 350 LED24-W RO	210
16943	ASTRA 250 DM LED-W RO	192	17170	ASTRA 320 LED-N CR	198	17566	DELTA DM LED-W GR	219	17785	GAMMA 350 LED24-W BL	210
16945	ASTRA 250 DM LED-W BL	192	17177	ASTRA 320 LED-N NE	198	17567	DELTA DM LED-W AT	219	17790	GAMMA 350 LED24-N TR	210
16950	ASTRA 250 DM LED-N TR	192	17179	ASTRA 320 LED-N AL	198	17570	DELTA DM LED-N CR	219	17792	GAMMA 350 LED24-N GI	210
16952	ASTRA 250 DM LED-N GI	192	17180	ASTRA 320 DM LED-W CR	198	17571	DELTA DM LED-N BI	219	17793	GAMMA 350 LED24-N RO	210
16953	ASTRA 250 DM LED-N RO	192	17187	ASTRA 320 DM LED-W NE	198	17576	DELTA DM LED-N GR	219	17795	GAMMA 350 LED24-N BL	210
16955	ASTRA 250 DM LED-N BL	192	17189	ASTRA 320 DM LED-W AL	198	17577	DELTA DM LED-N AT	219	17800	GAMMA 350 DM LED-W TR	210
16960	ASTRA 300 LED-W TR	192	17190	ASTRA 320 DM LED-N CR	198	17580	DISCO 260 LED-W TR	233	17802	GAMMA 350 DM LED-W GI	210
16962	ASTRA 300 LED-W GI	192	17197	ASTRA 320 DM LED-N NE	198	17582	DISCO 260 LED-W GI	233	17803	GAMMA 350 DM LED-W RO	210
16963	ASTRA 300 LED-W RO	192	17199	ASTRA 320 DM LED-N AL	198	17583	DISCO 260 LED-W RO	233	17805	GAMMA 350 DM LED-W BL	210
16965	ASTRA 300 LED-W BL	192	17200	ASTRA 370 LED-W CR	198	17585	DISCO 260 LED-W BL	233	17810	GAMMA 350 DM LED-N TR	210
16970	ASTRA 300 LED-N TR	192	17207	ASTRA 370 LED-W NE	198	17590	DISCO 260 LED-N TR	233	17812	GAMMA 350 DM LED-N GI	210
16972	ASTRA 300 LED-N GI	192	17209	ASTRA 370 LED-W AL	198	17592	DISCO 260 LED-N GI	233	17813	GAMMA 350 DM LED-N RO	210
16973	ASTRA 300 LED-N RO	192	17210	ASTRA 370 LED-N CR	198	17593	DISCO 260 LED-N RO	233	17815	GAMMA 350 DM LED-N BL	210
16975	ASTRA 300 LED-N BL	192	17217	ASTRA 370 LED-N NE	198	17595	DISCO 260 LED-N BL	233	17820	GAMMA 450 LED-W TR	211
16980	ASTRA 300 LED24-W TR	192	17219	ASTRA 370 LED-N AL	198	17600	DISCO 260 LED24-W TR	233	17822	GAMMA 450 LED-W GI	211
16982	ASTRA 300 LED24-W GI	192	17220	ASTRA 370 DM LED-W CR	198	17602	DISCO 260 LED24-W GI	233	17823	GAMMA 450 LED-W RO	211
16983	ASTRA 300 LED24-W RO	192	17227	ASTRA 370 DM LED-W NE	198	17603	DISCO 260 LED24-W RO	233	17825	GAMMA 450 LED-W BL	211
16985	ASTRA 300 LED24-W BL	192	17229	ASTRA 370 DM LED-W AL	198	17605	DISCO 260 LED24-W BL	233	17830	GAMMA 450 LED-N TR	211
16990	ASTRA 300 LED24-W RO	192	17230	ASTRA 370 DM LED-N CR	198	17610	DISCO 260 LED24-N TR	233	17832	GAMMA 450 LED-N GI	211
16992	ASTRA 300 LED24-N GI	192	17237	ASTRA 370 DM LED-N NE	198	17612	DISCO 260 LED24-N GI	233	17833	GAMMA 450 LED-N RO	211
16993	ASTRA 300 LED24-N RO	192	17239	ASTRA 370 DM LED-N AL	198	17613	DISCO 260 LED24-N RO	233	17835	GAMMA 450 LED-N BL	211
16995	ASTRA 300 LED24-N BL	192	17240	ASTRA 470 LED-W CR	199	17615	DISCO 260 LED24-N BL	233	17840	GAMMA 450 DM LED-W TR	211
17000	ASTRA 300 DM LED-W TR	192	17247	ASTRA 470 LED-W NE	199	17620	DISCO 260 DM LED-W TR	233	17842	GAMMA 450 DM LED-W GI	211
17002	ASTRA 300 DM LED-W GI	192	17249	ASTRA 470 LED-W AL	199	17622	DISCO 260 DM LED-W GI	233	17843	GAMMA 450 DM LED-W RO	211
17003	ASTRA 300 DM LED-W RO	192	17250	ASTRA 470 LED-N CR	199	17623	DISCO 260 DM LED-W RO	233	17845	GAMMA 450 DM LED-W BL	211
17005	ASTRA 300 DM LED-W BL	192	17257	ASTRA 470 LED-N NE	199	17625	DISCO 260 DM LED-W BL	233	17850	GAMMA 450 DM LED-N TR	211
17010	ASTRA 300 DM LED-N TR	192	17259	ASTRA 470 LED-N AL	199	17630	DISCO 260 DM LED-N TR	233	17852	GAMMA 450 DM LED-N GI	211
17012	ASTRA 300 DM LED-N GI	192	17260	ASTRA 470 DM LED-W CR	199	17632	DISCO 260 DM LED-N GI	233	17853	GAMMA 450 DM LED-N RO	211
17013	ASTRA 300 DM LED-N RO	192	17267	ASTRA 470 DM LED-W NE	199	17633	DISCO 260 DM LED-N RO	233	17855	GAMMA 450 DM LED-N BL	211
17015	ASTRA 300 DM LED-N BL	192	17269	ASTRA 470 DM LED-W AL	199	17635	DISCO 260 DM LED-N BL	233	17860	GAMMA 270 LED-W CR	214
17020	ASTRA 360 LED-W TR	193	17270	ASTRA 470 DM LED-N CR	199	17640	DISCO 310 LED-W TR	233	17861	GAMMA 270 LED-W BI	214
17022	ASTRA 360 LED-W GI	193	17277	ASTRA 470 DM LED-N NE	199	17642	DISCO 310 LED-W GI	233	17862	GAMMA 270 LED-W OR	214
17023	ASTRA 360 LED-W RO	193	17279	ASTRA 470 DM LED-N AL	199	17643	DISCO 310 LED-W RO	233	17870	GAMMA 270 LED-N CR	214
17025	ASTRA 360 LED-W BL	193	17280	ASTRA 570 LED-W CR	199	17645	DISCO 310 LED-W BL	233	17871	GAMMA 270 LED-N BI	214
17030	ASTRA 360 LED-N TR	193	17287	ASTRA 570 LED-W NE	199	17650	DISCO 310 LED-N TR	233	17872	GAMMA 270 LED-N OR	214
17032	ASTRA 360 LED-N GI	193	17289	ASTRA 570 LED-W AL	199	17652	DISCO 310 LED-N GI	233	17880	GAMMA 270 DM LED-W CR	214
17033	ASTRA 360 LED-N RO	193	17290	ASTRA 570 LED-N CR	199	17653	DISCO 310 LED-N RO	233	17881	GAMMA 270 DM LED-W BI	214
17035	ASTRA 360 LED-N BL	193	17297	ASTRA 570 LED-N NE	199	17655	DISCO 310 LED-N BL	233	17882	GAMMA 270 DM LED-W OR	214
17040	ASTRA 360 LED24-W TR	193	17299	ASTRA 570 LED-N AL	199	17660	DISCO 310 LED24-W TR	233	17890	GAMMA 270 DM LED-N CR	214
17042	ASTRA 360 LED24-W GI	193	17300	ASTRA 570 DM LED-W CR	199	17662	DISCO 310 LED24-W GI	233	17891	GAMMA 270 DM LED-N BI	214
17043	ASTRA 360 LED24-W RO	193	17307	ASTRA 570 DM LED-W NE	199	17663	DISCO 310 LED24-W RO	233	17892	GAMMA 270 DM LED-N RO	214
17045	ASTRA 360 LED24-W BL	193	17309	ASTRA 570 DM LED-W AL	199	17665	DISCO 310 LED24-W BL	233	17900	GAMMA 370 LED-W CR	214
17050	ASTRA 360 LED24-N TR	193	17310	ASTRA 570 DM LED-N CR	199	17670	DISCO 310 LED24-N TR	233	17901	GAMMA 370 LED-W BI	214
17052	ASTRA 360 LED24-N GI	193	17317	ASTRA 570 DM LED-N NE	199	17672	DISCO 310 LED24-N GI	233	17902	GAMMA 370 LED-W OR	214
17053	ASTRA 360 LED24-N RO	193	17319	ASTRA 570 DM LED-N AL	199	17673	DISCO 310 LED24-N RO	233	17910	GAMMA 370 LED-N CR	214
17055	ASTRA 360 LED24-N BL	193	17320	BETA LED-W CR	217	17675	DISCO 310 LED24-N BL	233	17911	GAMMA 370 LED-N BI	214
17060	ASTRA 360 DM LED-W TR	193	17321	BETA LED-W BI	217	17680	DISCO 310 DM LED-W TR	233	17912	GAMMA 370 LED-N OR	214
17062	ASTRA 360 DM LED-W GI	193	17326	BETA LED-W GR	217	17682	DISCO 310 DM LED-W GI	233	17920	GAMMA 370 DM LED-W CR	214
17063	ASTRA 360 DM LED-W RO	193	17327	BETA LED-W AT	217	17683	DISCO 310 DM LED-W RO	233	17921	GAMMA 370 DM LED-W BI	214
17065	ASTRA 360 DM LED-W BL	193	17330	BETA LED-N CR	217	17685	DISCO 310 DM LED-W BL	233	17922	GAMMA 370 DM LED-W OR	214
17070	ASTRA 360 DM LED-N TR	193	17331	BETA LED-N BI	217	17690	DISCO 310 DM LED-N TR	233	17930	GAMMA 370 DM LED-N CR	214
17072	ASTRA 360 DM LED-N GI	193	17336	BETA LED-N GR	217	17692	DISCO 310 DM LED-N GI	233	17931	GAMMA 370 DM LED-N BI	214
17073	ASTRA 360 DM LED-N RO	193	17337	BETA LED-N AT	217	17693	DISCO 310 DM LED-N RO	233	17932	GAMMA 370 DM LED-N OR	214
17075	ASTRA 360 DM LED-N BL	193	17340	BETA DM LED-W CR	217	17695	DISCO 310 DM LED-N BL	233	17940	GAMMA 470 LED-W CR	215
17080	ASTRA 450 LED-W TR	194	17341	BETA DM LED-W BI	217	17700	GAMMA 250 LED-W TR	210	17941	GAMMA 470 LED-W BI	215
17082	ASTRA 450 LED-W GI	194	17346	BETA DM LED-W GR	217	17702	GAMMA 250 LED-W GI	210	17942	GAMMA 470 LED-W OR	215
17083	ASTRA 450 LED-W RO	194	17347	BETA DM LED-W AT	217	17703	GAMMA 250 LED-W RO	210	17950	GAMMA 470 LED-N CR	215
17085	ASTRA 450 LED-W BL	194	17350	BETA DM LED-N CR	217	17705	GAMMA 250 LED-W BL	210	17951	GAMMA 470 LED-N BI	215
17090	ASTRA 450 LED-N TR	194	17351	BETA DM LED-N BI	217	17710	GAMMA 250 LED-N TR	210	17952	GAMMA 470 LED-N OR	215
17092	ASTRA 450 LED-N GI	194	17356	BETA DM LED-N GR	217	17712	GAMMA 250 LED-N GI	210	17960	GAMMA 470 DM LED-W CR	215
17093	ASTRA 450 LED-N RO	194	17357	BETA DM LED-N AT	217	17713	GAMMA 250 LED-N RO	210	17961	GAMMA 470 DM LED-W BI	215
17095	ASTRA 450 LED-N BL	194	17360	BOLLA 260 LED-W TR	236	17715	GAMMA 250 LED-N BL	210	17962	GAMMA 470 DM LED-N CR	215
17100	ASTRA 450 DM LED-W TR	194	17370	BOLLA 260 LED-N TR	236	17720	GAMMA 250 LED24-W TR	210	17970	GAMMA 470 DM LED-N CR	215
17102	ASTRA 450 DM LED-W GI	194	17380	BOLLA 260 LED24-W TR	236	17722	GAMMA 250 LED24-W GI	210	17971	GAMMA 470 DM LED-N BI	215
17103	ASTRA 450 DM LED-W RO	194	17390	BOLLA 260 LED24-N TR	236	17723	GAMMA 250 LED24-W RO	210	17972	GAMMA 470 DM LED-N OR	215
17105	ASTRA 450 DM LED-W BL	194	17400	BOLLA 260 DM LED-W TR	236	17725	GAMMA 250 LED24-W BL	210	18020	BETA EL CR	217
17110	ASTRA 450 DM LED-N TR	194	17410	BOLLA 260 DM LED-N TR	236	17730	GAMMA 250 LED24-N TR	210	18021	BETA EL BI	217
17112	ASTRA 450 DM LED-N GI	194	17420	BOLLA 310 LED-W TR	236	17732	GAMMA 250 LED24-N GI	210	18026	BETA EL GR	217
17113	ASTRA 450 DM LED-N RO	194	17430	BOLLA 310 LED-N TR	236	17733	GAMMA 250 LED24-N RO	210	18027	BETA EL AT	217
17115	ASTRA 450 DM LED-N BL	194	17440	BOLLA 310 LED24-W TR	236	17735	GAMMA 250 LED24-N BL	210	18050	BOLLA 370 EL IP TR	237
17120	ASTRA 550 LED-W TR	195	17450	BOLLA 310 DM LED24-N TR	236	17740	GAMMA 250 DM LED-W TR	210	18580	YOYO P600 EL CR	161
17122	ASTRA 550 LED-W GI	195	17460	BOLLA 310 DM LED-W TR	236	17742	GAMMA 250 DM LED-W GI	210	18581	YOYO P600 EL BI	161

cod.	artículo/item	pag.	cod.	artículo/item	pag.	cod.	artículo/item	pag.	cod.	artículo/item	pag.
18600	YOYO P900 EL CR	161	20070	ASTRA MINI 200 EL CR	201	20521	VOG IQ-N BI	183	23329	MEGA 360 IP AL	207
18601	YOYO P900 EL BI	161	20077	ASTRA MINI 200 EL NE	201	20529	VOG IQ-N AL	183	23330	MEGA 460 IP CR	207
18630	COSMO P300 EL TR	165	20079	ASTRA MINI 200 EL AL	201	23030	ASTRA 250 IP TR	192	23339	MEGA 460 IP AL	207
18632	COSMO P300 EL GI	165	20091	ASTRA MINI 170 LED-W	201	23032	ASTRA 250 IP GI	192	23380	QUADRO 250 IP TR	231
18633	COSMO P300 EL RO	165	20101	ASTRA MINI 170 LED-N	201	23033	ASTRA 250 IP RO	192	23382	QUADRO 250 IP GI	231
18635	COSMO P300 EL BL	165	20110	ASTRA MINI 200 LED-W CR	201	23035	ASTRA 250 IP BL	192	23383	QUADRO 250 IP RO	231
18640	COSMO P400 EL/42 TR	165	20117	ASTRA MINI 200 LED-W NE	201	23040	ASTRA 300 IP TR	192	23385	QUADRO 250 IP BL	231
18642	COSMO P400 EL/42 GI	165	20119	ASTRA MINI 200 LED-W AL	201	23042	ASTRA 300 IP GI	192	23390	QUADRO 300 IP TR	231
18643	COSMO P400 EL/42 RO	165	20120	ASTRA MINI 200 LED-N CR	201	23043	ASTRA 300 IP RO	192	23392	QUADRO 300 IP GI	231
18645	COSMO P400 EL/42 BL	165	20127	ASTRA MINI 200 LED-N NE	201	23045	ASTRA 300 IP BL	192	23393	QUADRO 300 IP RO	231
18650	COSMO P400 EL/84 TR	165	20129	ASTRA MINI 200 LED-N AL	201	23050	ASTRA 360 IP TR	193	23395	QUADRO 300 IP BL	231
18652	COSMO P400 EL/84 GI	165	20131	FLASH I1S-W BI	176	23052	ASTRA 360 IP GI	193	24001	FLASH PS-W BI	174
18653	COSMO P400 EL/84 RO	165	20139	FLASH I1S-W AL	176	23053	ASTRA 360 IP RO	193	24009	FLASH PS-W AL	174
18655	COSMO P400 EL/84 BL	165	20141	FLASH I1S-N BI	176	23055	ASTRA 360 IP BL	193	24011	FLASH PS-N BI	174
18670	DELTA EL CR	219	20149	FLASH I1S-N AL	176	23060	ASTRA 450 IP TR	194	24019	FLASH PS-N AL	174
18671	DELTA EL BI	219	20151	FLASH I1S-W DM BI	176	23062	ASTRA 450 IP GI	194	24021	FLASH PS-W DM BI	174
18676	DELTA EL GR	219	20159	FLASH I1S-W DM AL	176	23063	ASTRA 450 IP RO	194	24029	FLASH PS-W DM AL	174
18677	DELTA EL AT	219	20161	FLASH I1S-N DM BI	176	23065	ASTRA 450 IP BL	194	24031	FLASH PS-N DM BI	174
18731	OMEGA 400 EL BI	239	20169	FLASH I1S-N DM AL	176	23070	ASTRA 550 IP TR	195	24039	FLASH PS-N DM AL	174
18736	OMEGA 400 EL CR	239	20171	FLASH I1L-W BI	176	23072	ASTRA 550 IP GI	195	24041	FLASH PL-W BI	174
18737	OMEGA 400 EL NE	239	20179	FLASH I1L-W AL	176	23073	ASTRA 550 IP RO	195	24049	FLASH PL-W AL	174
18741	OMEGA 500 EL BI	239	20181	FLASH I1L-N BI	176	23075	ASTRA 550 IP BL	195	24051	FLASH PL-N BI	174
18746	OMEGA 500 EL CR	239	20189	FLASH I1L-N AL	176	23080	ASTRA 320 IP CR	198	24059	FLASH PL-N AL	174
18747	OMEGA 500 EL NE	239	20191	FLASH I1L-W DM BI	176	23087	ASTRA 320 IP NE	198	24061	FLASH PL-W DM BI	174
18760	BETA DM CR	217	20199	FLASH I1L-W DM AL	176	23089	ASTRA 320 IP AL	198	24069	FLASH PL-W DM AL	174
18761	BETA DM BI	217	20201	FLASH I1L-N DM BI	176	23090	ASTRA 370 IP CR	198	24071	FLASH PL-N DM BI	174
18766	BETA DM GR	217	20209	FLASH I1L-N DM AL	176	23097	ASTRA 370 IP NE	198	24079	FLASH PL-N DM AL	174
18767	BETA DM AT	217	20211	FLASH I2S-W BI	176	23099	ASTRA 370 IP AL	198	28010	ASTRA 300 DM IP TR	192
18771	TOP PLUS EL/52 TR	185	20219	FLASH I2S-W AL	176	23100	ASTRA 470 IP CR	199	28012	ASTRA 300 DM IP GI	192
18772	TOP PLUS EL/52 GI	185	20221	FLASH I2S-N BI	176	23107	ASTRA 470 IP NE	199	28013	ASTRA 300 DM IP RO	192
18773	TOP PLUS EL/52 RO	185	20229	FLASH I2S-N AL	176	23109	ASTRA 470 IP AL	199	28015	ASTRA 300 DM IP BL	192
18775	TOP PLUS EL/52 BL	185	20231	FLASH I2S-W DM BI	176	23110	ASTRA 570 IP CR	199	28030	ASTRA 320 DM IP CR	198
18810	BOLLA 310 DM IP TR	236	20239	FLASH I2S-W DM AL	176	23117	ASTRA 570 IP NE	199	28037	ASTRA 320 DM IP NE	198
18820	BOLLA 370 DM IP TR	237	20241	FLASH I2S-N DM BI	176	23119	ASTRA 570 IP AL	199	28039	ASTRA 320 DM IP AL	198
18830	COSMO P400 DM/84 TR	165	20249	FLASH I2S-N DM AL	176	23120	BETA CR	217	28050	ASTRA 360 DM IP TR	193
18832	COSMO P400 DM/84 GI	165	20251	FLASH I2L-W BI	176	23121	BETA BI	217	28052	ASTRA 360 DM IP GI	193
18833	COSMO P400 DM/84 RO	165	20259	FLASH I2L-W AL	176	23126	BETA GR	217	28053	ASTRA 360 DM IP RO	193
18835	COSMO P400 DM/84 BL	165	20261	FLASH I2L-N BI	176	23127	BETA AT	217	28055	ASTRA 360 DM IP BL	193
18840	DELTA DM CR	219	20269	FLASH I2L-N AL	176	23130	BOLLA 260 IP TR	236	28070	ASTRA 370 DM IP CR	198
18841	DELTA DM BI	219	20271	FLASH I2L-W DM BI	176	23140	BOLLA 310 IP TR	236	28077	ASTRA 370 DM IP NE	198
18846	DELTA DM GR	219	20279	FLASH I2L-W DM AL	176	23150	BOLLA 370 IP TR	237	28079	ASTRA 370 DM IP AL	198
18847	DELTA DM AT	219	20281	FLASH I2L-N DM BI	176	23160	DELTA CR	219	28090	ASTRA 450 DM IP TR	194
18860	GAMMA 370 DM IP CR	214	20289	FLASH I2L-N DM AL	176	23161	DELTA BI	219	28092	ASTRA 450 DM IP GI	194
18861	GAMMA 370 DM IP BI	214	20291	FLASH I4S-W BI	177	23166	DELTA GR	219	28093	ASTRA 450 DM IP RO	194
18862	GAMMA 370 DM IP OR	214	20299	FLASH I4S-W AL	177	23167	DELTA AT	219	28095	ASTRA 450 DM IP BL	194
18870	GAMMA 470 DM IP CR	215	20301	FLASH I4S-N BI	177	23170	DISCO 260 IP TR	233	28110	ASTRA 470 DM IP CR	199
18871	GAMMA 470 DM IP BI	215	20309	FLASH I4S-N AL	177	23172	DISCO 260 IP GI	233	28117	ASTRA 470 DM IP NE	199
18872	GAMMA 470 DM IP OR	215	20311	FLASH I4S-W DM BI	177	23173	DISCO 260 IP RO	233	28119	ASTRA 470 DM IP AL	199
18890	YOYO P600 DM CR	161	20319	FLASH I4S-W DM AL	177	23175	DISCO 260 IP BL	233	28130	ASTRA 550 DM IP TR	195
18891	YOYO P600 DM BI	161	20321	FLASH I4S-N DM BI	177	23180	DISCO 310 IP TR	233	28132	ASTRA 550 DM IP GI	195
18910	YOYO P900 DM CR	161	20329	FLASH I4S-N DM AL	177	23182	DISCO 310 IP GI	233	28133	ASTRA 550 DM IP RO	195
18911	YOYO P900 DM BI	161	20331	FLASH I4L-W BI	177	23183	DISCO 310 IP RO	233	28135	ASTRA 550 DM IP BL	195
18921	ALMA 400 EL BI	226	20339	FLASH I4L-W AL	177	23185	DISCO 310 IP BL	233	28150	ASTRA 570 DM IP CR	199
18931	ALMA 400 DM BI	226	20341	FLASH I4L-N BI	177	23190	GAMMA 250 IP TR	210	28157	ASTRA 570 DM IP NE	199
18941	ALMA 600 EL BI	227	20349	FLASH I4L-N AL	177	23192	GAMMA 250 IP GI	210	28159	ASTRA 570 DM IP AL	199
18951	ALMA 600 DM BI	227	20351	FLASH I4L-W DM BI	177	23193	GAMMA 250 IP RO	210	28160	DISCO 310 DM IP TR	233
18961	GRIFFE 400 EL BI	222	20359	FLASH I4L-W DM AL	177	23195	GAMMA 250 IP BL	210	28162	DISCO 310 DM IP GI	233
18971	GRIFFE 400 DM BI	222	20361	FLASH I4L-N DM BI	177	23200	GAMMA 350 IP TR	210	28163	DISCO 310 DM IP RO	233
18981	GRIFFE 600 EL BI	223	20369	FLASH I4L-N DM AL	177	23202	GAMMA 350 IP GI	210	28165	DISCO 310 DM IP BL	233
18991	GRIFFE 600 DM BI	223	20371	FLASH IQS-W BI	177	23203	GAMMA 350 IP RO	210	28170	GAMMA 350 DM IP TR	210
19041	ASTRA 450 EL/64	194	20379	FLASH IQS-W AL	177	23205	GAMMA 350 IP BL	210	28172	GAMMA 350 DM IP GI	210
19051	ASTRA 550 EL/84	195	20381	FLASH IQS-N BI	177	23210	GAMMA 450 IP TR	211	28173	GAMMA 350 DM IP RO	210
19161	GAMMA 450 EL/64	211	20389	FLASH IQS-N AL	177	23212	GAMMA 450 IP GI	211	28175	GAMMA 350 DM IP BL	210
19281	TOP PLUS EL TR	185	20391	FLASH IQS-W DM BI	177	23213	GAMMA 450 IP RO	211	28180	GAMMA 450 DM IP TR	211
19282	TOP PLUS EL GI	185	20399	FLASH IQS-W DM AL	177	23215	GAMMA 450 IP BL	211	28182	GAMMA 450 DM IP GI	211
19283	TOP PLUS EL RO	185	20401	FLASH IQS-N DM BI	177	23220	GAMMA 270 IP CR	214	28183	GAMMA 450 DM IP RO	211
19285	TOP PLUS EL BL	185	20409	FLASH IQS-N DM AL	177	23221	GAMMA 270 IP BI 1	214	28185	GAMMA 450 DM IP BL	211
19561	VIP 500 CR	167	20411	FLASH IQL-W BI	177	23222	GAMMA 270 IP OR	214	28190	MEGA 450 DM IP TR	205
19566	VIP 500 NS	167	20419	FLASH IQL-W AL	177	23230	GAMMA 370 IP CR	214	28192	MEGA 450 DM IP GI	205
19571	VIP 501 CR	167	20421	FLASH IQL-N BI	177	23231	GAMMA 370 IP BI	214	28193	MEGA 450 DM IP RO	205
19576	VIP 501 NS	167	20429	FLASH IQL-N AL	177	23232	GAMMA 370 IP OR	214	28195	MEGA 450 DM IP BL	205
19781	VIP 501 DM CR	167	20431	FLASH IQL-W DM BI	177	23240	GAMMA 470 IP CR	215	28200	QUADRO 300 DM IP TR	231
19786	VIP 501 DM NS	167	20439	FLASH IQL-W DM AL	177	23241	GAMMA 470 IP BI	215	28202	QUADRO 300 DM IP GI	231
19811	ASTRA 450 DM/64	194	20441	FLASH IQL-N DM BI	177	23242	GAMMA 470 IP OR	215	28203	QUADRO 300 DM IP RO	231
19821	ASTRA 550 DM/84	195	20449	FLASH IQL-N DM AL	177	23280	MEGA 250 IP TR	204	28205	QUADRO 300 DM IP BL	231
19841	GAMMA 450 DM/64	211	20451	VOG I1-W BI	182	23282	MEGA 250 IP GI	204	28220	ASTRA 300 EL IP TR	192
19951	LELLA 250 EL BI	241	20459	VOG I1-W AL	182	23283	MEGA 250 IP RO	204	28222	ASTRA 300 EL IP GI	192
19958	LELLA 250 EL RU	241	20461	VOG I1-N BI	182	23285	MEGA 250 IP BL	204	28223	ASTRA 300 EL IP RO	192
19959	LELLA 250 EL AL	241	20469	VOG I1-N AL	182	23290	MEGA 350 IP TR	204	28225	ASTRA 300 EL IP BL	192
19961	LELLA 300 EL BI	241	20471	VOG I2-W BI	182	23292	MEGA 350 IP GI	204	28230	ASTRA 360 EL IP TR	193
19968	LELLA 300 EL RU	241	20479	VOG I2-W AL	182	23293	MEGA 350 IP RO	204	28232	ASTRA 360 EL IP GI	193
19969	LELLA 300 EL AL	241	20481	VOG I2-N BI	182	23295	MEGA 350 IP BL	204	28233	ASTRA 360 EL IP RO	193
19971	REGOLO 250 EL	229	20489	VOG I2-N AL	182	23300	MEGA 450 IP TR	205	28235	ASTRA 360 EL IP BL	193
19981	REGOLO 350 EL	229	20491	VOG I4-W BI	183	23302	MEGA 450 IP GI	205	28240	ASTRA 450 EL IP TR	194
20041	ASTRA MINI 170	201	20499	VOG I4-W AL	183	23303	MEGA 450 IP RO	205	28242	ASTRA 450 EL IP GI	194
20051	ASTRA MINI 170 EL	201	20501	VOG I4-N BI	183	23305	MEGA 450 IP BL	205	28243	ASTRA 450 EL IP RO	194
20060	ASTRA MINI 200 CR	201	20509	VOG I4-N AL	183	23310	MEGA 260 IP CR	207	28245	ASTRA 450 EL IP BL	194
20067	ASTRA MINI 200 NE	201	20511	VOG IQ-W BI	183	23319	MEGA 260 IP AL	207	28250	ASTRA 550 EL IP TR	195
20069	ASTRA MINI 200 AL	201	20519	VOG IQ-W AL	183	23320	MEGA 360 IP CR	207	28252	ASTRA 550 EL IP GI	195

14 applique interni/esterni
wall lights indoor/outdoor

150 plafoniere interni/esterni
ceiling bowls indoor/outdoor

248 testaletto
bed head units

258 sospensioni
suspensions

344 lampade
lamps

384 lampioni ed incassi
bollards & recessed lights

450 indice
index

cod.	articolo/item	pag.	cod.	articolo/item	pag.	cod.	articolo/item	pag.	cod.	articolo/item	pag.
28253	ASTRA 550 EL IP RO	195	30216	DUO AP 90/4X39 EM AL	45	30626	SPLIT 90 EM LED-W AL	37	32130	PALLINO 300	87
28255	ASTRA 550 EL IP BL	195	30218	DUODK AP 90/4X39 EM CR	169	30630	SPLIT 90S EM LED-W CR	37	32161	SIRYA 1	81
28300	GAMMA 350 EL IP TR	210	30219	DUODK AP 90/4X39 EM AL	169	30636	SPLIT 90S EM LED-W AL	37	32171	SIRYA 2	81
28302	GAMMA 350 EL IP GI	210	30220	SPLIT 60/2X24 EM CR	36	30640	SPLIT 90 EM LED-N CR	37	32181	SPICCHIO	85
28303	GAMMA 350 EL IP RO	210	30226	SPLIT 60/2X24 EM AL	36	30646	SPLIT 90 EM LED-N AL	37	32191	VELA	79
28305	GAMMA 350 EL IP BL	210	30228	SPLITDK 60/2X24 EM CR	171	30650	SPLIT 90S EM LED-N CR	37	32231	AURORA 250 BI	75
28310	GAMMA 450 EL IP TR	211	30229	SPLITDK 60/2X24 EM AL	171	30656	SPLIT 90S EM LED-N AL	37	32241	AURORA 430 BI	75
28312	GAMMA 450 EL IP GI	211	30230	SPLIT 90/2X39 EM CR	37	30660	SPLIT 120 EM LED-W CR	38	32271	SPICCHIO TIRANTE	85
28313	GAMMA 450 EL IP RO	211	30236	SPLIT 90/2X39 EM AL	37	30666	SPLIT 120 EM LED-W AL	38	32300	TRILYUM AP	83
28315	GAMMA 450 EL IP BL	211	30238	SPLITDK 90/2X39 EM CR	171	30670	SPLIT 120S EM LED-W CR	38	32330	OPERA	93
28360	DISCO 310 EL IP TR	233	30239	SPLITDK 90/2X39 EM AL	171	30676	SPLIT 120S EM LED-W AL	38	32341	VIP 1 CR	77
28362	DISCO 310 EL IP GI	233	30240	SPLIT 120/2X54 EM CR	38	30680	SPLIT 120 EM LED-N CR	38	32346	VIP 1 NS	77
28363	DISCO 310 EL IP RO	233	30246	SPLIT 120/2X54 EM AL	38	30686	SPLIT 120 EM LED-N AL	38	32351	VIP 2 CR	77
28365	DISCO 310 EL IP BL	233	30248	SPLITDK 120/2X54 EM CR	171	30690	SPLIT 120S EM LED-N CR	38	32356	VIP 2 NS	77
28380	QUADRO 300 EL IP TR	231	30249	SPLITDK 120/2X54 EM AL	171	30696	SPLIT 120S EM LED-N AL	38	34001	GINA DX LED-W BI	71
28382	QUADRO 300 EL IP GI	231	30250	SPLIT 150/2X80 EM CR	39	30700	SPLIT 150 EM LED-W CR	39	34007	GINA DX LED-W NE	71
28383	QUADRO 300 EL IP RO	231	30256	SPLIT 150/2X80 EM AL	39	30706	SPLIT 150 EM LED-W AL	39	34011	GINA SX LED-W BI	71
28385	QUADRO 300 EL IP BL	231	30258	SPLITDK 150/2X80 EM CR	171	30710	SPLIT 150S EM LED-W CR	39	34017	GINA SX LED-W NE	71
28440	ASTRA 320 EL IP CR	198	30259	SPLITDK 150/2X80 EM AL	171	30716	SPLIT 150S EM LED-W AL	39	34021	GINA DX LED-N BI	71
28447	ASTRA 320 EL IP NE	198	30260	TEGOLA 40/24 EM CR	99	30720	SPLIT 150 EM LED-N CR	39	34027	GINA DX LED-N NE	71
28449	ASTRA 320 EL IP AL	198	30261	TEGOLA 40/24 EM BI	99	30726	SPLIT 150 EM LED-N AL	39	34031	GINA SX LED-N BI	71
28450	ASTRA 370 EL IP CR	198	30270	TEGOLA 60/55 EM CR	99	30730	SPLIT 150S EM LED-N CR	39	34037	GINA SX LED-N NE	71
28457	ASTRA 370 EL IP NE	198	30271	TEGOLA 60/55 EM BI	99	30736	SPLIT 150S EM LED-N AL	39	34041	OVETTO 230 LED-W BI	55
28459	ASTRA 370 EL IP AL	198	30281	VIP 1 EM CR	77	30740	DUO AP 60 EM LED-W CR	44	34051	OVETTO 230 LED-N BI	55
28460	ASTRA 470 EL IP CR	199	30286	VIP 1 EM NS	77	30746	DUO AP 60 EM LED-W AL	44	34061	OVETTO 350 LED-W BI	55
28467	ASTRA 470 EL IP NE	199	30291	VIP 2 EM/84 CR	77	30750	DUO AP 60S EM LED-W CR	44	34071	OVETTO 350 LED-N BI	55
28469	ASTRA 470 EL IP AL	199	30296	VIP 2 EM/84 NS	77	30756	DUO AP 60S EM LED-W AL	44	34081	PAGODA LED-W BI	57
28470	ASTRA 570 EL IP CR	199	30340	TAB RGB DIG CR	27	30760	DUO AP 60 EM LED-N CR	44	34091	PAGODA LED-N BI	57
28477	ASTRA 570 EL IP NE	199	30341	TAB RGB DIG AN	27	30766	DUO AP 60 EM LED-N AL	44	34101	TAB MAXI LED-W BI	31
28479	ASTRA 570 EL IP AL	199	30346	TAB RGB DIG AL	27	30770	DUO AP 60S EM LED-N CR	44	34102	TAB MAXI LED-W GI	31
28480	GAMMA 370 EL IP CR	214	30347	TAB RGB DIG NE	27	30776	DUO AP 60S EM LED-N AL	44	34103	TAB MAXI LED-W AR	31
28481	GAMMA 370 EL IP BI	214	30350	TAB RGB DALI CR	27	30780	DUO AP 90 EM LED-W CR	45	34108	TAB MAXI LED-W TO	31
28482	GAMMA 370 EL IP OR	214	30351	TAB RGB DALI AN	27	30786	DUO AP 90 EM LED-W AL	45	34111	TAB MAXI DIG LED-W BI	31
28490	GAMMA 470 EL IP CR	215	30356	TAB RGB DALI AL	27	30790	DUO AP 90S EM LED-W CR	45	34112	TAB MAXI DIG LED-W GI	31
28491	GAMMA 470 EL IP BI	215	30357	TAB RGB DALI NE	27	30796	DUO AP 90S EM LED-W AL	45	34113	TAB MAXI DIG LED-W AR	31
28492	GAMMA 470 EL IP OR	215	30360	TAB1 RGB DIG CR	27	30800	DUO AP 90 EM LED-N CR	45	34118	TAB MAXI DIG LED-W TO	31
28520	BOLLA 310 EL IP TR	236	30361	TAB1 RGB DIG AN	27	30806	DUO AP 90 EM LED-N AL	45	34121	TAB MAXI DALI LED-W BI	31
28540	MEGA 450 EL IP TR	205	30366	TAB1 RGB DIG AL	27	30810	DUO AP 90S EM LED-N CR	45	34122	TAB MAXI DALI LED-W GI	31
28542	MEGA 450 EL IP GI	205	30367	TAB1 RGB DIG NE	27	30816	DUO AP 90S EM LED-N AL	45	34123	TAB MAXI DALI LED-W AR	31
28543	MEGA 450 EL IP RO	205	30370	TAB1 RGB DALI CR	27	30821	SIRYA 2 EM LED-W	81	34128	TAB MAXI DALI LED-W TO	31
28545	MEGA 450 EL IP BL	205	30371	TAB1 RGB DALI AN	27	30831	SIRYA 2 EM LED-N	81	34131	TAB MAXI LED-N BI	31
28560	MEGA 460 EL IP CR	207	30376	TAB1 RGB DALI AL	27	30841	DOMO 300 EM LED-W BI	101	34132	TAB MAXI LED-N GI	31
28569	MEGA 460 EL IP AL	207	30377	TAB1 RGB DALI NE	27	30846	DOMO 300 EM LED-W GR	101	34133	TAB MAXI LED-N AR	31
28580	MEGA 460 DM IP CR	207	30381	VELA EM	79	30847	DOMO 300 EM LED-W AT	101	34138	TAB MAXI LED-N TO	31
28589	MEGA 460 DM IP AL	207	30421	VELA EM LED-W	79	30848	DOMO 300 EM LED-W RU	101	34141	TAB MAXI DIG LED-N BI	31
28651	TUTTOTONDO P600 EL BI	156	30431	VELA EM LED-N	79	30851	DOMO 300S EM LED-W BI	101	34142	TAB MAXI DIG LED-N GI	31
28656	TUTTOTONDO P600 EL AL	156	30440	TAB EM LED-W CR	21	30856	DOMO 300S EM LED-W GR	101	34143	TAB MAXI DIG LED-N AR	31
28657	TUTTOTONDO P600 EL NE	156	30441	TAB EM LED-W AN	21	30857	DOMO 300S EM LED-W AT	101	34148	TAB MAXI DIG LED-N TO	31
28661	TUTTOTONDO P600 DM BI	156	30446	TAB EM LED-W AL	21	30858	DOMO 300S EM LED-W RU	101	34151	TAB MAXI DALI LED-N BI	31
28666	TUTTOTONDO P600 DM AL	156	30447	TAB EM LED-W NE	21	30861	DOMO 300 EM LED-N BI	101	34152	TAB MAXI DALI LED-N GI	31
28667	TUTTOTONDO P600 DM NE	156	30450	TAB EM LED-N CR	21	30866	DOMO 300 EM LED-N GR	101	34153	TAB MAXI DALI LED-N AR	31
28671	TUTTOTONDO P900 EL BI	156	30451	TAB EM LED-N AN	21	30867	DOMO 300 EM LED-N AT	101	34158	TAB MAXI DALI LED-N TO	31
28676	TUTTOTONDO P900 EL AL	156	30456	TAB EM LED-N AL	21	30868	DOMO 300 EM LED-N RU	101	34161	FLASH AS-W BI	51
28677	TUTTOTONDO P900 EL NE	156	30457	TAB EM LED-N NE	21	30871	DOMO 300S EM LED-N BI	101	34169	FLASH AS-W AL	51
28681	TUTTOTONDO P900 DM BI	156	30460	TAB1 EM LED-W CR	23	30876	DOMO 300S EM LED-N GR	101	34171	FLASH AS-N BI	51
28686	TUTTOTONDO P900 DM AL	156	30461	TAB1 EM LED-W AN	23	30877	DOMO 300S EM LED-N AT	101	34179	FLASH AS-N AL	51
28687	TUTTOTONDO P900 DM NE	156	30466	TAB1 EM LED-W AL	23	30878	DOMO 300S EM LED-N RU	101	34181	FLASH AS-W DM BI	51
30002	SIRYA 2 EM/52	81	30467	TAB1 EM LED-W NE	23	30881	TAB MAXI EM LED-W BI	31	34189	FLASH AS-W DM AL	51
30020	SPLITDK 60/24 EM CR	36	30470	TAB1 EM LED-N CR	23	30882	TAB MAXI EM LED-W GI	31	34191	FLASH AS-N DM BI	51
30026	SPLIT 60/24 EM AL	36	30471	TAB1 EM LED-N AN	23	30883	TAB MAXI EM LED-W AR	31	34199	FLASH AS-N DM AL	51
30028	SPLITDK 60/24 EM CR	171	30476	TAB1 EM LED-N AL	23	30888	TAB MAXI EM LED-W TO	31	34201	FLASH AL-W BI	51
30029	SPLITDK 60/24 EM AL	171	30477	TAB1 EM LED-N NE	23	30891	TAB MAXI EM LED-N BI	31	34209	FLASH AL-W AL	51
30040	SPLIT 90/39 EM CR	37	30481	AURORA 430 EM LED-W BI	75	30892	TAB MAXI EM LED-N GI	31	34211	FLASH AL-N BI	51
30046	SPLIT 90/39 EM AL	37	30491	AURORA 430 EM LED-N BI	75	30893	TAB MAXI EM LED-N AR	31	34219	FLASH AL-N AL	51
30048	SPLITDK 90/39 EM CR	171	30501	VIP 1 EM LED-W CR	77	30898	TAB MAXI EM LED-N TO	31	34221	FLASH AL-W DM BI	51
30049	SPLITDK 90/39 EM AL	171	30506	VIP 1 EM LED-W NS	77	30997	CASSAFORMA TAB1	23	34229	FLASH AL-W DM AL	51
30050	SPLIT 120/54 EM CR	38	30511	VIP 1 EM LED-N CR	77	31040	CHROME CR	63	34231	FLASH AL-N DM BI	51
30056	SPLIT 120/54 EM AL	38	30516	VIP 1 EM LED-N NS	77	31047	CHROME NE	63	34239	FLASH AL-N DM AL	51
30058	SPLITDK 120/54 EM CR	171	30521	VIP 2 EM LED-W CR	77	31091	OMEGA AP BI	89	34241	VOG A-W BI	53
30059	SPLITDK 120/54 EM AL	171	30526	VIP 2 EM LED-W NS	77	31096	OMEGA AP CR	89	34249	VOG A-W AL	53
30060	SPLIT 150/80 EM CR	39	30531	VIP 2 EM LED-N CR	77	31097	OMEGA AP NE	89	34251	VOG A-N BI	53
30066	SPLIT 150/80 EM AL	39	30536	VIP 2 EM LED-N NS	77	31210	RETRO' AP CR	67	34259	VOG A-N AL	53
30068	SPLITDK 150/80 EM CR	171	30540	TEGOLA 40 EM LED-W CR	99	31212	RETRO' AP OR	67	34261	FORMA-W BI	33
30069	SPLITDK 150/80 EM AL	171	30541	TEGOLA 40 EM LED-W BI	99	31220	SEGNO CR	69	34262	FORMA-W GI	33
30120	DUO AP 60/2X24 EM CR	44	30550	TEGOLA 40 EM LED-N CR	99	31221	SEGNO BI	69	34263	FORMA-W AR	33
30126	DUO AP 60/2X24 EM AL	44	30551	TEGOLA 40 EM LED-N BI	99	31250	DADO P LISSE' CR	65	34268	FORMA-W TO	33
30128	DUODK AP 60/2X24 EM CR	169	30560	TEGOLA 60 EM LED-W CR	99	31252	DADO P LISSE' AV7 IP20	65	34271	FORMA-N BI	33
30129	DUODK AP 60/2X24 EM AL	169	30561	TEGOLA 60 EM LED-W BI	99	31258	DADO CR	65	34272	FORMA-N GI	33
30130	DUO AP 90/2X39 EM CR	45	30570	TEGOLA 60 EM LED-N CR	99	31511	KYO AP BI	59	34273	FORMA-N AR	33
30136	DUO AP 90/2X39 EM AL	45	30571	TEGOLA 60 EM LED-N BI	99	31512	KYO AP GI	59	34278	FORMA-N TO	33
30138	DUODK AP 90/2X39 EM CR	169	30580	SPLIT 60 EM LED-W CR	36	31513	KYO AP AR	59	34281	KYO AP LED-W BI	59
30139	DUODK AP 90/2X39 EM AL	169	30586	SPLIT 60 EM LED-W AL	36	31516	KYO AP AL	59	34282	KYO AP LED-W GI	59
30181	DOMO 300/2X42 EM BI	101	30590	SPLIT 60S EM LED-W CR	36	32031	GIROTONDO DX	95	34283	KYO AP LED-W AR	59
30186	DOMO 300/2X42 EM CR	101	30596	SPLIT 60S EM LED-W AL	36	32041	GIROTONDO SX	95	34286	KYO AP LED-W BI	59
30187	DOMO 300/2X42 EM AT	101	30600	SPLIT 60 EM LED-N CR	36	32051	GOCCIA	97	34291	KYO AP LED-N BI	59
30188	DOMO 300/2X42 EM RU	101	30606	SPLIT 60 EM LED-N AL	36	32071	MEGA 1	91	34292	KYO AP LED-N GI	59
30191	AURORA 430 EM BI	75	30610	SPLIT 60S EM LED-N CR	36	32081	MEGA 2	91	34293	KYO AP LED-N AR	59
30200	OPERA EM	93	30616	SPLIT 60S EM LED-N AL	36	32120	PALLINO 190	87	34296	KYO AP LED-N AL	59
30210	DUO AP 90/4X39 EM CR	45	30620	SPLIT 90 EM LED-W CR	37	32121	PALLINO 190 TIRANTE	87	35011	DOMO 130/70 MD-EL BI	101

cod.	articolo/item	pag.	cod.	articolo/item	pag.	cod.	articolo/item	pag.	cod.	articolo/item	pag.
35016	DOMO 130/70 MD-EL GR	101	35540	DUO AP 60S DM LED-N CR	44	36637	TAB LED24-W NE	21	38041	AURORA 430 EL BI	75
35017	DOMO 130/70 MD-EL AT	101	35546	DUO AP 60S DM LED-N AL	44	36640	TAB DIG LED-W CR	21	38051	GIROTONDO DX EL	95
35018	DOMO 130/70 MD-EL RU	101	35550	DUO AP 90 LED-W CR	45	36641	TAB DIG LED-W AN	21	38061	GIROTONDO SX EL	95
35111	VIP 1 LED-W CR	77	35556	DUO AP 90 LED-W AL	45	36646	TAB DIG LED-W AL	21	38071	GOCCIA EL	97
35116	VIP 1 LED-W NS	77	35560	DUO AP 90S LED-W CR	45	36647	TAB DIG LED-W NE	21	38081	VIP 2 DM CR	77
35121	VIP 1 LED-N CR	77	35566	DUO AP 90S LED-W AL	45	36650	TAB DALI LED-W CR	21	38086	VIP 2 DM NS	77
35126	VIP 1 LED-N NS	77	35570	DUO AP 90S DM LED-W CR	45	36651	TAB DALI LED-W AN	21	38091	PALLINO 300 EL	87
35131	VIP 2 LED-W CR	77	35576	DUO AP 90S DM LED-W AL	45	36656	TAB DALI LED-W AL	21	38110	SEGNO EL CR	69
35136	VIP 2 LED-W NS	77	35580	DUO AP 90 LED-N CR	45	36657	TAB DALI LED-W NE	21	38111	SEGNO EL BI	69
35141	VIP 2 DM LED-W CR	77	35586	DUO AP 90 LED-N AL	45	36660	TAB LED-N CR	21	38120	DADO PLISSE' EL CR	65
35146	VIP 2 DM LED-W NS	77	35590	DUO AP 90S LED-N CR	45	36661	TAB LED-N AN	21	38122	DADO PLISSE' EL AV	65
35151	VIP 2 LED-N CR	77	35596	DUO AP 90S LED-N AL	45	36666	TAB LED-N AL	21	38128	DADO EL CR	65
35156	VIP 2 LED-N NS	77	35600	DUO AP 90S DM LED-N CR	45	36667	TAB LED-N NE	21	38130	TEGOLA 40/24 EL CR	99
35161	VIP 2 DM LED-N CR	77	35606	DUO AP 90S DM LED-N AL	45	36670	TAB LED24-N CR	21	38131	TEGOLA 40/24 EL BI	99
35166	VIP 2 DM LED-N NS	77	35610	ERGO 60 LED-W CR	47	36671	TAB LED24-N AN	21	38140	TEGOLA 40/2X24 EL CR	99
35170	TEGOLA 40 LED-W CR	99	35620	ERGO 60 LED-N CR	47	36676	TAB LED24-N AL	21	38141	TEGOLA 40/2X24 EL BI	99
35171	TEGOLA 40 LED-W BI	99	35631	SIRYA 1 LED-W	81	36677	TAB LED24-N NE	21	38160	TEGOLA 60/55 EL CR	99
35180	TEGOLA 40 DM LED-W CR	99	35641	SIRYA 1 LED-N	81	36680	TAB DIG LED-N CR	21	38161	TEGOLA 60/55 EL BI	99
35181	TEGOLA 40 DM LED-W BI	99	35651	SIRYA 2 LED-W	81	36681	TAB DIG LED-N AN	21	38170	TEGOLA 60/2X55 EL CR	99
35190	TEGOLA 40 LED-N CR	99	35661	SIRYA 2 LED-N	81	36686	TAB DIG LED-N AL	21	38171	TEGOLA 60/2X55 EL BI	99
35191	TEGOLA 40 LED-N BI	99	35671	SPICCHIO LED-W	85	36687	TAB DIG LED-N NE	21	38200	TEGOLA 40/2X24 DM CR	99
35200	TEGOLA 40 DM LED-N CR	99	35681	SPICCHIO LED-N	85	36690	TAB DALI LED-N CR	21	38201	TEGOLA 40/2X24 DM BI	99
35201	TEGOLA 40 DM LED-N BI	99	35691	SPICCHIO TIRANTE LED-W	85	36691	TAB DALI LED-N AN	21	38210	TEGOLA 60/2X55 DM CR	99
35210	TEGOLA 60 LED-W CR	99	35701	SPICCHIO TIRANTE LED-N	85	36696	TAB DALI LED-N AL	21	38211	TEGOLA 60/2X55 DM BI	99
35211	TEGOLA 60 LED-W BI	99	35711	PALLINO 300 LED-W	87	36697	TAB DALI LED-N NE	21	39052	SIRYA 1 EL	81
35220	TEGOLA 60 DM LED-W CR	99	35721	PALLINO 300 LED-N	87	36700	TAB1 LED-W CR	23	39062	SIRYA 2 EL	81
35221	TEGOLA 60 DM LED-W BI	99	35731	ASIA AP LED-W BI	61	36701	TAB1 LED-W AN	23	39120	TRILYUM AP EL	83
35230	TEGOLA 60 LED-N CR	99	35737	ASIA AP LED-W NE	61	36706	TAB1 LED-W AL	23	39150	OPERA EL/26	93
35231	TEGOLA 60 LED-N BI	99	35741	ASIA AP LED-N BI	61	36707	TAB1 LED-W NE	23	39181	VIP 2 EL CR	77
35240	TEGOLA 60 DM LED-N CR	99	35747	ASIA AP LED-N NE	61	36710	TAB1 LED24-W CR	23	39186	VIP 2 EL NS	77
35241	TEGOLA 60 DM LED-N BI	99	35751	OMEGA AP LED-W BI	89	36711	TAB1 LED24-W AN	23	39210	SPLIT 60/24 EL CR	36
35250	SPLIT 60 LED-W CR	36	35756	OMEGA AP LED-W CR	89	36716	TAB1 LED24-W AL	23	39216	SPLIT 60/24 EL AL	36
35256	SPLIT 60 LED-W AL	36	35757	OMEGA AP LED-W NE	89	36717	TAB1 LED24-W NE	23	39218	SPLITDK 60/24 EL CR	171
35260	SPLIT 60S LED-W CR	36	35761	OMEGA AP LED-N BI	89	36720	TAB1 DIG LED-W CR	23	39219	SPLITDK 60/24 EL AL	171
35266	SPLIT 60S LED-W AL	36	35766	OMEGA AP LED-N CR	89	36721	TAB1 DIG LED-W AN	23	39220	SPLIT 90/39 EL CR	37
35270	SPLIT 60S DM LED-W CR	36	35767	OMEGA AP LED-N NE	89	36726	TAB1 DIG LED-W AL	23	39226	SPLIT 90/39 EL AL	37
35276	SPLIT 60S DM LED-W AL	36	35771	MEGA 1 LED-W	91	36727	TAB1 DIG LED-W NE	23	39228	SPLITDK 90/39 EL CR	171
35280	SPLIT 60 LED-N CR	36	35781	MEGA 1 LED-N	91	36730	TAB1 DALI LED-W CR	23	39229	SPLITDK 90/39 EL AL	171
35286	SPLIT 60 LED-N AL	36	35791	MEGA 2 LED-W TR	91	36731	TAB1 DALI LED-W AN	23	39230	SPLIT 120/54 EL CR	38
35290	SPLIT 60S LED-N CR	36	35801	MEGA 2 LED-N TR	91	36736	TAB1 DALI LED-W AL	23	39236	SPLIT 120/54 EL AL	38
35296	SPLIT 60S LED-N AL	36	35810	OPERA LED-W	93	36737	TAB1 DALI LED-W NE	23	39238	SPLITDK 120/54 EL CR	171
35300	SPLIT 60S DM LED-N CR	36	35820	OPERA LED-N	93	36740	TAB1 LED-N CR	23	39239	SPLITDK 120/54 EL AL	171
35306	SPLIT 60S DM LED-N AL	36	35831	GIROTONDO DX LED-W	95	36741	TAB1 LED-N AN	23	39240	SPLIT 150/80 EL CR	39
35310	SPLIT 90 LED-W CR	37	35841	GIROTONDO SX LED-W	95	36746	TAB1 LED-N AL	23	39246	SPLIT 150/80 EL AL	39
35316	SPLIT 90 LED-W AL	37	35851	GIROTONDO DX LED-N	95	36747	TAB1 LED-N NE	23	39248	SPLITDK 150/80 EL CR	171
35320	SPLIT 90S LED-W CR	37	35861	GIROTONDO SX LED-N	95	36750	TAB1 LED24-N CR	23	39249	SPLITDK 150/80 EL AL	171
35326	SPLIT 90S LED-W AL	37	35871	GOCCIA LED-W	97	36751	TAB1 LED24-N AN	23	39250	SPLIT 60/2X24 EL CR	36
35330	SPLIT 90S DM LED-W CR	37	35881	GOCCIA LED-N	97	36756	TAB1 LED24-N AL	23	39256	SPLIT 60/2X24 EL AL	36
35336	SPLIT 90S DM LED-W AL	37	35891	DOMO 130 LED-W BI	101	36757	TAB1 LED24-N NE	23	39258	SPLITDK 60/2X24 EL CR	171
35340	SPLIT 90 LED-N CR	37	35896	DOMO 130 LED-W GR	101	36760	TAB1 DIG LED-N CR	23	39259	SPLITDK 60/2X24 EL AL	171
35346	SPLIT 90 LED-N AL	37	35897	DOMO 130 LED-W AT	101	36761	TAB1 DIG LED-N AN	23	39260	SPLIT 90/2X39 EL CR	37
35350	SPLIT 90S LED-N CR	37	35898	DOMO 130 LED-W RU	101	36766	TAB1 DIG LED-N AL	23	39266	SPLIT 90/2X39 EL AL	37
35356	SPLIT 90S LED-N AL	37	35901	DOMO 130S LED-W BI	101	36767	TAB1 DIG LED-N NE	23	39268	SPLITDK 90/2X39 EL CR	171
35360	SPLIT 90S DM LED-N CR	37	35906	DOMO 130S LED-W GR	101	36770	TAB1 DALI LED-N CR	23	39269	SPLITDK 90/2X39 EL AL	171
35366	SPLIT 90S DM LED-N AL	37	35907	DOMO 130S LED-W AT	101	36771	TAB1 DALI LED-N AN	23	39270	SPLIT 120/2X54 EL CR	38
35370	SPLIT 120 LED-W CR	38	35908	DOMO 130S LED-W RU	101	36776	TAB1 DALI LED-N AL	23	39276	SPLIT 120/2X54 EL AL	38
35376	SPLIT 120 LED-W AL	38	35911	DOMO 130S DM LED-W BI	101	36777	TAB1 DALI LED-N NE	23	39278	SPLITDK 120/2X54 EL CR	171
35380	SPLIT 120S LED-W CR	38	35916	DOMO 130S DM LED-W GR	101	36821	VELA LED-W	79	39279	SPLITDK 120/2X54 EL AL	171
35386	SPLIT 120S LED-W AL	38	35917	DOMO 130S DM LED-W AT	101	36831	VELA LED-N	79	39280	SPLIT 150/2X80 EL CR	39
35390	SPLIT 120S DM LED-W CR	38	35918	DOMO 130S DM LED-W RU	101	36841	AURORA 250 LED-W BI	75	39286	SPLIT 150/2X80 EL AL	39
35396	SPLIT 120S DM LED-W AL	38	35921	DOMO 130 LED-N BI	101	36851	AURORA 250 LED-N BI	75	39288	SPLITDK 150/2X80 EL CR	171
35400	SPLIT 120 LED-N CR	38	35926	DOMO 130 LED-N GR	101	36861	AURORA 430 LED-W BI	75	39289	SPLITDK 150/2X80 EL AL	171
35406	SPLIT 120 LED-N AL	38	35927	DOMO 130 LED-N AT	101	36871	AURORA 430 LED-N BI	75	39300	OPERA EL/52	93
35410	SPLIT 120S LED-N CR	38	35928	DOMO 130 LED-N RU	101	36881	TAB2 LED-W BI	29	39380	DUO AP 60/2X24 EL CR	44
35416	SPLIT 120S LED-N AL	38	35931	DOMO 130S LED-N BI	101	36886	TAB2 LED-W AL	29	39386	DUO AP 60/2X24 EL AL	44
35420	SPLIT 120S DM LED-N CR	38	35936	DOMO 130S LED-N GR	101	36891	TAB2 LED-N BI	29	39388	DUODK AP 60/2X24 EL CR	169
35426	SPLIT 120S DM LED-N AL	38	35937	DOMO 130S LED-N AT	101	36896	TAB2 LED-N AL	29	39389	DUODK AP 60/2X24 EL AL	169
35430	SPLIT 150 LED-W CR	39	35938	DOMO 130S LED-N RU	101	36901	TAB2 DIG LED-W BI	29	39390	DUO AP 90/2X39 EL CR	45
35436	SPLIT 150 LED-W AL	39	35941	DOMO 130S DM LED-N BI	101	36906	TAB2 DIG LED-W AL	29	39396	DUO AP 90/2X39 EL AL	45
35440	SPLIT 150S LED-W CR	39	35946	DOMO 130S DM LED-N GR	101	36911	TAB2 DIG LED-N BI	29	39398	DUODK AP 90/2X39 EL CR	169
35446	SPLIT 150S LED-W AL	39	35947	DOMO 130S DM LED-N AT	101	36916	TAB2 DIG LED-N AL	29	39399	DUODK AP 90/2X39 EL AL	169
35450	SPLIT 150S DM LED-W CR	39	35948	DOMO 130S DM LED-N RU	101	36921	TAB2 DALI LED-W BI	29	39400	DUO AP 60/4X24 EL CR	44
35456	SPLIT 150S DM LED-W AL	39	35951	DOMO 130/150 MD-EL BI	101	36926	TAB2 DALI LED-W AL	29	39406	DUO AP 60/4X24 EL AL	44
35460	SPLIT 150 LED-N CR	39	35956	DOMO 130/150 MD-EL GR	101	36931	TAB2 DALI LED-N BI	29	39408	DUODK AP 60/4X24 EL CR	169
35466	SPLIT 150 LED-N AL	39	35957	DOMO 130/150 MD-EL AT	101	36936	TAB2 DALI LED-N AL	29	39409	DUODK AP 60/4X24 EL AL	169
35470	SPLIT 150S LED-N CR	39	35958	DOMO 130/150 MD-EL RU	101	36940	SPLIT 20 LED-W IN CR	40	39410	DUO AP 90/4X39 EL CR	45
35476	SPLIT 150S LED-N AL	39	35960	TRILYUM AP LED-W	83	36946	SPLIT 20 LED-W IN AL	40	39416	DUO AP 90/4X39 EL AL	45
35480	SPLIT 150S DM LED-N CR	39	35970	TRILYUM AP LED-N	83	36950	SPLIT 20 LED-N IN CR	40	39418	DUODK AP 90/4X39 EL CR	169
35486	SPLIT 150S DM LED-N AL	39	35981	LOLLO LED-W BI	73	36956	SPLIT 20 LED-N IN AL	40	39419	DUODK AP 90/4X39 EL AL	169
35490	DUO AP 60 LED-W CR	44	35987	LOLLO LED-W NE	73	36960	SPLIT 60 LED-W IN CR	40	39501	DOMO 130/2X42 EL BI	101
35496	DUO AP 60 LED-W AL	44	35991	LOLLO LED-N BI	73	36966	SPLIT 60 LED-W IN AL	40	39506	DOMO 130/2X42 EL GR	101
35500	DUO AP 60S LED-W CR	44	35997	LOLLO LED-N NE	73	36970	SPLIT 60 LED-N IN CR	40	39507	DOMO 130/2X42 EL AT	101
35506	DUO AP 60S LED-W AL	44	36620	TAB LED-W CR	21	36976	SPLIT 60 LED-N IN AL	40	39508	DOMO 130/2X42 EL RU	101
35510	DUO AP 60S DM LED-W CR	44	36621	TAB LED-W AN	21	36980	SPLIT 20 LED-W CR	36	39521	SPICCHIO EL	85
35516	DUO AP 60S DM LED-W AL	44	36626	TAB LED-W AL	21	36986	SPLIT 20 LED-W AL	36	39531	SPICCHIO TIRANTE EL	85
35520	DUO AP 60 LED-N CR	44	36627	TAB LED-W NE	21	36990	SPLIT 20 LED-N CR	36	39561	VELA EL	79
35526	DUO AP 60 LED-N AL	44	36630	TAB LED24-W CR	21	36996	SPLIT 20 LED-N AL	36	39571	VIP 1 EL CR	77
35530	DUO AP 60S LED-N CR	44	36631	TAB LED24-W AN	21	37050	TI-LIGHT AP	49	39576	VIP 1 EL NS	77
35536	DUO AP 60S LED-N AL	44	36636	TAB LED24-W AL	21	38031	AURORA 250 EL BI	75	39620	SPLIT 20/18 IN CR	40

14 appliche interni/esterni
wall lights indoor/outdoor

150 plafoniere interni/esterni
ceiling bowls indoor/outdoor

248 testaleto
bed head units

258 sospensioni
suspensions

344 lampade
lamps

384 lampioni ed incassi
bollards & recessed lights

450 indice
index

cod.	articolo/item	pag.	cod.	articolo/item	pag.	cod.	articolo/item	pag.	cod.	articolo/item	pag.
39626	SPLIT 20/18 IN AL	40	46091	TOP EXTRA DM LED-N AT-TR	188	50068	PLAN 60 EM LED-W RU	113	51107	A8 200 AT	444
39630	SPLIT 20/18 EL CR	36	46092	TOP EXTRA DM LED-N AT-GI	188	50071	PLAN 60 EM LED-N BI	113	51108	A8 200 RU	444
39636	SPLIT 20/18 EL AL	36	46093	TOP EXTRA DM LED-N AT-RO	188	50076	PLAN 60 EM LED-N GR	113	51161	RING 350 BI	243
39670	SPLIT 60/24 IN CR	40	46095	TOP EXTRA DM LED-N AT-BL	188	50077	PLAN 60 EM LED-N AT	113	51166	RING 350 GR	243
39676	SPLIT 60/24 IN AL	40	46101	TOP EXTRA LED-W BI-TR	187	50078	PLAN 60 EM LED-N RU	113	51167	RING 350 AT	243
39680	DUO AP 60/4X24 DM CR	44	46102	TOP EXTRA LED-W BI-GI	187	50081	BLIK 60 EM LED-W BI	119	51168	RING 350 RU	243
39686	DUO AP 60/4X24 DM AL	44	46103	TOP EXTRA LED-W BI-RO	187	50086	BLIK 60 EM LED-W GR	119	51176	KROS GR	145
39688	DUODK AP 60/4X24 DM CR	169	46105	TOP EXTRA LED-W BI-BL	187	50087	BLIK 60 EM LED-W AT	119	51177	KROS AT	145
39689	DUODK AP 60/4X24 DM AL	169	46111	TOP EXTRA LED-N BI-TR	187	50088	BLIK 60 EM LED-W RU	119	51178	KROS RU	145
39690	DUO AP 90/4X39 DM CR	45	46112	TOP EXTRA LED-N BI-GI	187	50091	BLIK 60 EM LED-N BI	119	51186	BAND GR	143
39696	DUO AP 90/4X39 DM AL	45	46113	TOP EXTRA LED-N BI-RO	187	50096	BLIK 60 EM LED-N GR	119	51187	BAND AT	143
39698	DUODK AP 90/4X39 DM CR	169	46115	TOP EXTRA LED-N BI-BL	187	50097	BLIK 60 EM LED-N AT	119	51188	BAND RU	143
39699	DUODK AP 90/4X39 DM AL	169	46121	TOP EXTRA DM LED-W BI-TR	187	50098	BLIK 60 EM LED-N RU	119	51226	KING GR	247
39700	SPLIT 90/2X39 DM CR	37	46122	TOP EXTRA DM LED-W BI-GI	187	50101	STAR C60 EM LED-W BI	123	51227	KING AT	247
39706	SPLIT 90/2X39 DM AL	37	46123	TOP EXTRA DM LED-W BI-RO	187	50106	STAR C60 EM LED-W GR	123	51228	KING RU	247
39708	SPLITDK 90/2X39 DM CR	171	46125	TOP EXTRA DM LED-W BI-BL	187	50107	STAR C60 EM LED-W AT	123	51236	QUEEN GR	245
39709	SPLITDK 90/2X39 DM AL	171	46131	TOP EXTRA DM LED-N BI-TR	187	50108	STAR C60 EM LED-W RU	123	51237	QUEEN AT	245
39710	SPLIT 120/2X54 DM CR	38	46132	TOP EXTRA DM LED-N BI-GI	187	50111	STAR C60 EM LED-N BI	123	51238	QUEEN RU	245
39716	SPLIT 120/2X54 DM AL	38	46133	TOP EXTRA DM LED-N BI-RO	187	50116	STAR C60 EM LED-N GR	123	51246	ASSO GR	147
39718	SPLITDK 120/2X54 DM CR	171	46135	TOP EXTRA DM LED-N BI-BL	187	50117	STAR C60 EM LED-N AT	123	51247	ASSO AT	147
39719	SPLITDK 120/2X54 DM AL	171	46141	TOP EXTRA LED-W GR-TR	187	50118	STAR C60 EM LED-N RU	123	51248	ASSO RU	147
39720	SPLIT 150/2X80 DM CR	39	46142	TOP EXTRA LED-W GR-GI	187	50121	STAR L60 EM LED-W BI	125	54001	PLAN 20 LED-W BI	112
39726	SPLIT 150/2X80 DM AL	39	46143	TOP EXTRA LED-W GR-RO	187	50126	STAR L60 EM LED-W GR	125	54006	PLAN 20 LED-W GR	112
39728	SPLITDK 150/2X80 DM CR	171	46145	TOP EXTRA LED-W GR-BL	187	50127	STAR L60 EM LED-W AT	125	54007	PLAN 20 LED-W AT	112
39729	SPLITDK 150/2X80 DM AL	171	46151	TOP EXTRA LED-N GR-TR	187	50128	STAR L60 EM LED-W RU	125	54008	PLAN 20 LED-W RU	112
40001	TOP EXTRA EM AT-TR	188	46152	TOP EXTRA LED-N GR-GI	187	50131	STAR L60 EM LED-N BI	125	54011	PLAN 20 LED-N BI	112
40002	TOP EXTRA EM AT-GI	188	46153	TOP EXTRA LED-N GR-RO	187	50136	STAR L60 EM LED-N GR	125	54016	PLAN 20 LED-N GR	112
40003	TOP EXTRA EM AT-RO	188	46155	TOP EXTRA LED-N GR-BL	187	50137	STAR L60 EM LED-N AT	125	54017	PLAN 20 LED-N AT	112
40005	TOP EXTRA EM AT-BL	188	46161	TOP EXTRA DM LED-W GR-TR	187	50138	STAR L60 EM LED-N RU	125	54018	PLAN 20 LED-N RU	112
40011	TOP EXTRA EM GR-TR	187	46162	TOP EXTRA DM LED-W GR-GI	187	50141	COVER EM LED-W AT-TR	141	54021	PLAN 30 LED-W BI	112
40012	TOP EXTRA EM GR-GI	187	46163	TOP EXTRA DM LED-W GR-RO	187	50142	COVER EM LED-W AT-GI	141	54026	PLAN 30 LED-W GR	112
40013	TOP EXTRA EM GR-RO	187	46165	TOP EXTRA DM LED-W GR-BL	187	50143	COVER EM LED-W AT-RO	141	54027	PLAN 30 LED-W AT	112
40015	TOP EXTRA EM GR-BL	187	46171	TOP EXTRA DM LED-N GR-TR	187	50145	COVER EM LED-W AT-BL	141	54028	PLAN 30 LED-W RU	112
40041	TOP EXTRA EM BI-TR	187	46172	TOP EXTRA DM LED-N GR-GI	187	50151	COVER EM LED-N AT-TR	141	54031	PLAN 30S LED-W BI	112
40042	TOP EXTRA EM BI-GI	187	46173	TOP EXTRA DM LED-N GR-RO	187	50152	COVER EM LED-N AT-GI	141	54036	PLAN 30S LED-W GR	112
40043	TOP EXTRA EM BI-RO	187	46175	TOP EXTRA DM LED-N GR-BL	187	50153	COVER EM LED-N AT-RO	141	54037	PLAN 30S LED-W AT	112
40045	TOP EXTRA EM BI-BL	187	46181	TOP EXTRA LED-W RU-TR	189	50155	COVER EM LED-N AT-BL	141	54038	PLAN 30S LED-W RU	112
40061	TOP EXTRA EM LED-W AT-TR	188	46191	TOP EXTRA LED-N RU-TR	189	50161	COVER EM LED-W GR-TR	141	54041	PLAN 30S DM LED-W BI	112
40062	TOP EXTRA EM LED-W AT-GI	188	46201	TOP EXTRA DM LED-W RU-TR	189	50162	COVER EM LED-W GR-GI	141	54046	PLAN 30S DM LED-W GR	112
40063	TOP EXTRA EM LED-W AT-RO	188	46211	TOP EXTRA DM LED-N RU-TR	189	50163	COVER EM LED-W GR-RO	141	54047	PLAN 30S DM LED-W AT	112
40065	TOP EXTRA EM LED-W AT-BL	188	48001	TOP EXTRA EL/52 AT-TR	188	50165	COVER EM LED-W GR-BL	141	54048	PLAN 30S DM LED-W RU	112
40071	TOP EXTRA EM LED-N AT-TR	188	48002	TOP EXTRA EL/52 AT-GI	188	50171	COVER EM LED-N GR-TR	141	54051	PLAN 30 LED-N BI	112
40072	TOP EXTRA EM LED-N AT-GI	188	48003	TOP EXTRA EL/52 AT-RO	188	50172	COVER EM LED-N GR-GI	141	54056	PLAN 30 LED-N GR	112
40073	TOP EXTRA EM LED-N AT-RO	188	48005	TOP EXTRA EL/52 AT-BL	188	50173	COVER EM LED-N GR-RO	141	54057	PLAN 30 LED-N AT	112
40075	TOP EXTRA EM LED-N AT-BL	188	48011	TOP EXTRA EL/52 GR-TR	187	50175	COVER EM LED-N GR-BL	141	54058	PLAN 30 LED-N RU	112
40081	TOP EXTRA EM LED-W BI-TR	187	48012	TOP EXTRA EL/52 GR-GI	187	50181	COVER EM LED-W RU-TR	141	54061	PLAN 30S LED-N BI	112
40082	TOP EXTRA EM LED-W BI-GI	187	48013	TOP EXTRA EL/52 GR-RO	187	50191	COVER EM LED-N RU-TR	141	54066	PLAN 30S LED-N GR	112
40083	TOP EXTRA EM LED-W BI-RO	187	48015	TOP EXTRA EL/52 GR-BL	187	51001	A1 100 BI	442	54067	PLAN 30S LED-N AT	112
40085	TOP EXTRA EM LED-W BI-BL	187	48341	TOP EXTRA EL AT-TR	188	51006	A1 100 GR	442	54068	PLAN 30S LED-N RU	112
40091	TOP EXTRA EM LED-N BI-TR	187	48342	TOP EXTRA EL AT-GI	188	51007	A1 100 AT	442	54071	PLAN 30S DM LED-N BI	112
40092	TOP EXTRA EM LED-N BI-GI	187	48343	TOP EXTRA EL AT-RO	188	51008	A1 100 RU	442	54076	PLAN 30S DM LED-N GR	112
40093	TOP EXTRA EM LED-N BI-RO	187	48345	TOP EXTRA EL AT-BL	188	51011	A1 200 BI	442	54077	PLAN 30S DM LED-N AT	112
40095	TOP EXTRA EM LED-N BI-BL	187	48351	TOP EXTRA EL GR-TR	187	51016	A1 200 GR	442	54078	PLAN 30S DM LED-N RU	112
40101	TOP EXTRA EM LED-W GR-TR	187	48352	TOP EXTRA EL GR-GI	187	51017	A1 200 AT	442	54081	PLAN 60 LED-W BI	113
40102	TOP EXTRA EM LED-W GR-GI	187	48353	TOP EXTRA EL GR-RO	187	51018	A1 200 RU	442	54086	PLAN 60 LED-W GR	113
40103	TOP EXTRA EM LED-W GR-RO	187	48355	TOP EXTRA EL GR-BL	187	51021	A2 100 BI	442	54087	PLAN 60 LED-W AT	113
40105	TOP EXTRA EM LED-W GR-BL	187	48451	TOP EXTRA EL BI-TR	187	51026	A2 100 GR	442	54088	PLAN 60 LED-W RU	113
40111	TOP EXTRA EM LED-N GR-TR	187	48452	TOP EXTRA EL BI-GI	187	51027	A2 100 AT	442	54091	PLAN 60 DM LED-W BI	113
40112	TOP EXTRA EM LED-N GR-GI	187	48453	TOP EXTRA EL BI-RO	187	51028	A2 100 RU	442	54096	PLAN 60 DM LED-W GR	113
40113	TOP EXTRA EM LED-N GR-RO	187	48455	TOP EXTRA EL BI-BL	187	51031	A2 200 BI	442	54097	PLAN 60 DM LED-W AT	113
40115	TOP EXTRA EM LED-N GR-BL	187	48461	TOP EXTRA EL/52 BI-TR	187	51036	A2 200 GR	442	54098	PLAN 60 DM LED-W RU	113
40121	TOP EXTRA EM RU-TR	189	48462	TOP EXTRA EL/52 BI-GI	187	51037	A2 200 AT	442	54101	PLAN 60 LED-N BI	113
40131	TOP EXTRA EM LED-W RU-TR	189	48463	TOP EXTRA EL/52 BI-RO	187	51038	A2 200 RU	442	54106	PLAN 60 LED-N GR	113
40141	TOP EXTRA EM LED-N RU-TR	189	48465	TOP EXTRA EL/52 BI-BL	187	51041	A3 100 BI	443	54107	PLAN 60 LED-N AT	113
41451	TOP EXTRA AT-TR	188	48501	TOP EXTRA EL RU-TR	189	51046	A3 100 GR	443	54108	PLAN 60 LED-N RU	113
41452	TOP EXTRA AT-GI	188	48511	TOP EXTRA EL/52 RU-TR	189	51047	A3 100 AT	443	54111	PLAN 60 DM LED-N BI	113
41453	TOP EXTRA AT-RO	188	50006	KING EM LED-W GR	247	51048	A3 100 RU	443	54116	PLAN 60 DM LED-N GR	113
41455	TOP EXTRA AT-BL	188	50007	KING EM LED-W AT	247	51051	A3 200 BI	443	54117	PLAN 60 DM LED-N AT	113
41461	TOP EXTRA GR-TR	187	50008	KING EM LED-W RU	247	51056	A3 200 GR	443	54118	PLAN 60 DM LED-N RU	113
41462	TOP EXTRA GR-GI	187	50016	KING EM LED-N GR	247	51057	A3 200 AT	443	54121	PLAN 120 LED-W BI	113
41463	TOP EXTRA GR-RO	187	50017	KING EM LED-N AT	247	51058	A3 200 RU	443	54126	PLAN 120 LED-W GR	113
41465	TOP EXTRA GR-BL	187	50018	KING EM LED-N BI	247	51061	A4 100 BI	443	54127	PLAN 120 LED-W AT	113
41491	TOP EXTRA BI-TR	187	50026	QUEEN EM LED-W GR	245	51066	A4 100 GR	443	54128	PLAN 120 LED-W RU	113
41492	TOP EXTRA BI-GI	187	50027	QUEEN EM LED-W AT	245	51067	A4 100 AT	443	54131	PLAN 120 DM LED-W BI	113
41493	TOP EXTRA BI-RO	187	50028	QUEEN EM LED-W RU	245	51068	A4 100 RU	443	54136	PLAN 120 DM LED-W GR	113
41495	TOP EXTRA BI-BL	187	50036	QUEEN EM LED-N GR	245	51071	A4 200 BI	443	54137	PLAN 120 DM LED-W AT	113
41511	TOP EXTRA RU-TR	189	50037	QUEEN EM LED-N AT	245	51076	A4 200 GR	443	54138	PLAN 120 DM LED-W RU	113
46061	TOP EXTRA LED-W AT-TR	188	50038	QUEEN EM LED-N BI	245	51077	A4 200 AT	443	54141	PLAN 120 LED-N BI	113
46062	TOP EXTRA LED-W AT-GI	188	50041	RING 350 EM LED-W BI	243	51078	A4 200 RU	443	54146	PLAN 120 LED-N GR	113
46063	TOP EXTRA LED-W AT-RO	188	50046	RING 350 EM LED-W GR	243	51081	A6 200 BI	444	54147	PLAN 120 LED-N AT	113
46065	TOP EXTRA LED-W AT-BL	188	50047	RING 350 EM LED-W AT	243	51086	A6 200 GR	444	54148	PLAN 120 LED-N RU	113
46071	TOP EXTRA LED-N AT-TR	188	50048	RING 350 EM LED-W RU	243	51087	A6 200 AT	444	54151	PLAN 120 DM LED-N BI	113
46072	TOP EXTRA LED-N AT-GI	188	50051	RING 350 EM LED-N BI	243	51088	A6 200 RU	444	54156	PLAN 120 DM LED-N GR	113
46073	TOP EXTRA LED-N AT-RO	188	50056	RING 350 EM LED-N GR	243	51091	A7 200 BI	444	54157	PLAN 120 DM LED-N AT	113
46075	TOP EXTRA LED-N AT-BL	188	50057	RING 350 EM LED-N AT	243	51096	A7 200 GR	444	54158	PLAN 120 DM LED-N RU	113
46081	TOP EXTRA DM LED-W AT-TR	188	50058	RING 350 EM LED-N RU	243	51097	A7 200 AT	444	54161	BIPLAN 30 LED-W BI	115
46082	TOP EXTRA DM LED-W AT-GI	188	50061	PLAN 60 EM LED-W BI	113	51098	A7 200 RU	444	54166	BIPLAN 30 LED-W GR	115
46083	TOP EXTRA DM LED-W AT-RO	188	50066	PLAN 60 EM LED-W GR	113	51101	A8 200 BI	444	54167	BIPLAN 30 LED-W AT	115
46085	TOP EXTRA DM LED-W AT-BL	188	50067	PLAN 60 EM LED-W AT	113	51106	A8 200 GR	444	54168	BIPLAN 30 LED-W RU	115

cod.	articolo/item	pag.	cod.	articolo/item	pag.	cod.	articolo/item	pag.	cod.	articolo/item	pag.
54171	BIPLAN 30 DM LED-W BI	115	54396	BLIK 120 DM LED-N GR	119	54617	STEP 2 LED-N AT	128	55326	EQUOS 1 LED-N/120° GR	104
54176	BIPLAN 30 DM LED-W GR	115	54397	BLIK 120 DM LED-N AT	119	54618	STEP 2 LED-N RU	128	55327	EQUOS 1 LED-N/120° AT	104
54177	BIPLAN 30 DM LED-W AT	115	54398	BLIK 120 DM LED-N RU	119	54621	STEP 3 LED-W BI	128	55328	EQUOS 1 LED-N/120° RU	104
54178	BIPLAN 30 DM LED-W RU	115	54401	STAR C20 LED-W BI	122	54626	STEP 3 LED-W GR	128	55331	EQUOS 2 LED-N/5° BI	105
54181	BIPLAN 30 LED-N BI	115	54406	STAR C20 LED-W GR	122	54627	STEP 3 LED-W AT	128	55336	EQUOS 2 LED-N/5° GR	105
54186	BIPLAN 30 LED-N GR	115	54407	STAR C20 LED-W AT	122	54628	STEP 3 LED-W RU	128	55337	EQUOS 2 LED-N/5° AT	105
54187	BIPLAN 30 LED-N AT	115	54408	STAR C20 LED-N BI	122	54631	STEP 3 LED-N BI	128	55338	EQUOS 2 LED-N/5° RU	105
54188	BIPLAN 30 LED-N RU	115	54411	STAR C20 LED-N GR	122	54636	STEP 3 LED-N GR	128	55341	EQUOS 2 LED-N/40° BI	105
54191	BIPLAN 30 DM LED-N BI	115	54416	STAR C20 LED-N AT	122	54637	STEP 3 LED-N AT	128	55346	EQUOS 2 LED-N/40° GR	105
54196	BIPLAN 30 DM LED-N GR	115	54417	STAR C20 LED-N RU	122	54638	STEP 3 LED-N RU	128	55347	EQUOS 2 LED-N/40° AT	105
54197	BIPLAN 30 DM LED-N AT	115	54418	STAR C20 LED-N BI	122	54641	COVER LED-W AT-TR	141	55348	EQUOS 2 LED-N/40° RU	105
54198	BIPLAN 30 DM LED-N GR	115	54421	STAR C30 LED-W BI	122	54642	COVER LED-W AT-GI	141	55351	EQUOS 2 LED-N/120° BI	105
54201	BIPLAN 60 LED-W BI	115	54426	STAR C30 LED-W GR	122	54643	COVER LED-W AT-RO	141	55356	EQUOS 2 LED-N/120° GR	105
54206	BIPLAN 60 LED-W GR	115	54427	STAR C30 LED-W AT	122	54645	COVER LED-W AT-BL	141	55357	EQUOS 2 LED-N/120° AT	105
54207	BIPLAN 60 LED-W AT	115	54428	STAR C30 LED-W RU	122	54651	COVER LED-N AT-TR	141	55358	EQUOS 2 LED-N/120° RU	105
54208	BIPLAN 60 LED-W RU	115	54431	STAR C30S LED-W BI	122	54652	COVER LED-N AT-GI	141	55361	EQUOS 2 LED-N/MIX BI	105
54211	BIPLAN 60 DM LED-W BI	115	54436	STAR C30S LED-W GR	122	54653	COVER LED-N AT-RO	141	55366	EQUOS 2 LED-N/MIX GR	105
54216	BIPLAN 60 DM LED-W GR	115	54437	STAR C30S LED-W AT	122	54655	COVER LED-N AT-BL	141	55367	EQUOS 2 LED-N/MIX AT	105
54217	BIPLAN 60 DM LED-W AT	115	54438	STAR C30S LED-W RU	122	54661	COVER LED-W GR-TR	141	55368	EQUOS 2 LED-N/MIX RU	105
54218	BIPLAN 60 DM LED-W RU	115	54441	STAR C30 LED-N BI	122	54662	COVER LED-W GR-GI	141	55371	EQUOS 1 LED-W/5° BI	104
54221	BIPLAN 60 LED-N BI	115	54446	STAR C30 LED-N GR	122	54663	COVER LED-W GR-RO	141	55376	EQUOS 1 LED-W/5° GR	104
54226	BIPLAN 60 LED-N GR	115	54447	STAR C30 LED-N AT	122	54665	COVER LED-W GR-BL	141	55377	EQUOS 1 LED-W/5° AT	104
54227	BIPLAN 60 LED-N AT	115	54448	STAR C30 LED-N RU	122	54671	COVER LED-N GR-TR	141	55378	EQUOS 1 LED-W/5° RU	104
54228	BIPLAN 60 LED-N RU	115	54451	STAR C30S LED-N BI	122	54672	COVER LED-N GR-GI	141	55381	EQUOS 1 LED-W/40° BI	104
54231	BIPLAN 60 DM LED-N BI	115	54456	STAR C30S LED-N GR	122	54673	COVER LED-N GR-RO	141	55386	EQUOS 1 LED-W/40° GR	104
54236	BIPLAN 60 DM LED-N GR	115	54457	STAR C30S LED-N AT	122	54675	COVER LED-N GR-BL	141	55387	EQUOS 1 LED-W/40° AT	104
54237	BIPLAN 60 DM LED-N AT	115	54458	STAR C30S LED-N RU	122	54681	COVER LED-W RU-TR	141	55388	EQUOS 1 LED-W/40° RU	104
54238	BIPLAN 60 DM LED-N RU	115	54461	STAR C60 LED-W BI	123	54691	COVER LED-N RU-TR	141	55391	EQUOS 1 LED-W/120° BI	104
54241	BLIK 20 LED-W BI	118	54466	STAR C60 LED-W GR	123	54706	POLO LED-W GR	149	55396	EQUOS 1 LED-W/120° GR	104
54246	BLIK 20 LED-W GR	118	54467	STAR C60 LED-W AT	123	54707	POLO LED-W AT	149	55397	EQUOS 1 LED-W/120° AT	104
54247	BLIK 20 LED-W AT	118	54468	STAR C60 LED-W RU	123	54708	POLO LED-W RU	149	55398	EQUOS 1 LED-W/120° RU	104
54248	BLIK 20 LED-W RU	118	54471	STAR C60 LED-N BI	123	54716	POLO LED-N GR	149	55401	EQUOS 2 LED-W/5° BI	105
54251	BLIK 20 LED-N BI	118	54476	STAR C60 LED-N GR	123	54717	POLO LED-N AT	149	55406	EQUOS 2 LED-W/5° GR	105
54256	BLIK 20 LED-N GR	118	54477	STAR C60 LED-N AT	123	54718	POLO LED-N RU	149	55407	EQUOS 2 LED-W/5° AT	105
54257	BLIK 20 LED-N AT	118	54478	STAR C60 LED-N RU	123	54726	RIGA LED-W GR	149	55408	EQUOS 2 LED-W/5° RU	105
54258	BLIK 20 LED-N RU	118	54481	STAR C120 LED-W BI	123	54727	RIGA LED-W AT	149	55411	EQUOS 2 LED-W/40° BI	105
54261	BLIK 30 LED-W BI	118	54486	STAR C120 LED-W GR	123	54728	RIGA LED-W RU	149	55416	EQUOS 2 LED-W/40° GR	105
54266	BLIK 30 LED-W GR	118	54487	STAR C120 LED-W AT	123	54736	RIGA LED-N GR	149	55417	EQUOS 2 LED-W/40° AT	105
54267	BLIK 30 LED-W AT	118	54488	STAR C120 LED-W RU	123	54737	RIGA LED-N AT	149	55418	EQUOS 2 LED-W/40° RU	105
54268	BLIK 30 LED-W RU	118	54491	STAR C120 LED-N BI	123	54738	RIGA LED-N RU	149	55421	EQUOS 2 LED-W/120° BI	105
54271	BLIK 30S LED-W BI	118	54496	STAR C120 LED-N GR	123	54741	K4 100 LED-W BI	445	55426	EQUOS 2 LED-W/120° GR	105
54276	BLIK 30S LED-W GR	118	54497	STAR C120 LED-N AT	123	54746	K4 100 LED-W GR	445	55427	EQUOS 2 LED-W/120° AT	105
54277	BLIK 30S LED-W AT	118	54498	STAR C120 LED-N RU	123	54747	K4 100 LED-W AT	445	55428	EQUOS 2 LED-W/120° RU	105
54278	BLIK 30S LED-W RU	118	54501	STAR L30 LED-W BI	125	54748	K4 100 LED-W RU	445	55431	EQUOS 2 LED-W/MIX BI	105
54281	BLIK 30S DM LED-W BI	118	54506	STAR L30 LED-W GR	125	54751	K4 100 LED-N BI	445	55436	EQUOS 2 LED-W/MIX GR	105
54286	BLIK 30S DM LED-W GR	118	54507	STAR L30 LED-W AT	125	54756	K4 100 LED-N GR	445	55437	EQUOS 2 LED-W/MIX AT	105
54287	BLIK 30S DM LED-W AT	118	54508	STAR L30 LED-W RU	125	54757	K4 100 LED-N AT	445	55438	EQUOS 2 LED-W/MIX RU	105
54288	BLIK 30S DM LED-W RU	118	54511	STAR L30S LED-W BI	125	54758	K4 100 LED-N RU	445	55441	ARK 10 LED-W BI	134
54291	BLIK 30 LED-N BI	118	54516	STAR L30S LED-W GR	125	54761	K4 200 LED-W BI	445	55446	ARK 10 LED-W GR	134
54296	BLIK 30 LED-N GR	118	54517	STAR L30S LED-W AT	125	54766	K4 200 LED-W GR	445	55447	ARK 10 LED-W AT	134
54297	BLIK 30 LED-N AT	118	54518	STAR L30S LED-W RU	125	54767	K4 200 LED-W AT	445	55448	ARK 10 LED-W RU	134
54298	BLIK 30 LED-N RU	118	54521	STAR L30 LED-N BI	125	54768	K4 200 LED-W RU	445	55451	ARK 10 LED-N BI	134
54301	BLIK 30S LED-N BI	118	54526	STAR L30 LED-N GR	125	54771	K4 200 LED-N BI	445	55456	ARK 10 LED-N GR	134
54306	BLIK 30S LED-N GR	118	54527	STAR L30 LED-N AT	125	54776	K4 200 LED-N GR	445	55457	ARK 10 LED-N AT	134
54307	BLIK 30S LED-N AT	118	54528	STAR L30 LED-N RU	125	54777	K4 200 LED-N AT	445	55458	ARK 10 LED-N RU	134
54308	BLIK 30S LED-N RU	118	54531	STAR L30S LED-N BI	125	54778	K4 200 LED-N GR	445	55461	ARK 10/2 LED-W BI	134
54311	BLIK 30S DM LED-N BI	118	54536	STAR L30S LED-N GR	125	54781	K8 200 LED-W BI	445	55466	ARK 10/2 LED-W GR	134
54316	BLIK 30S DM LED-N GR	118	54537	STAR L30S LED-N AT	125	54786	K8 200 LED-W GR	445	55467	ARK 10/2 LED-W AT	134
54317	BLIK 30S DM LED-N AT	118	54538	STAR L30S LED-N RU	125	54787	K8 200 LED-W AT	445	55468	ARK 10/2 LED-W RU	134
54318	BLIK 30S DM LED-N RU	118	54541	STAR L60 LED-W BI	125	54788	K8 200 LED-W RU	445	55471	ARK 10/2 LED-N BI	134
54321	BLIK 60 LED-W BI	119	54546	STAR L60 LED-W GR	125	54791	K8 200 LED-N BI	445	55476	ARK 10/2 LED-N GR	134
54326	BLIK 60 LED-W GR	119	54547	STAR L60 LED-W AT	125	54796	K8 200 LED-N GR	445	55477	ARK 10/2 LED-N AT	134
54327	BLIK 60 LED-W AT	119	54548	STAR L60 LED-W RU	125	54797	K8 200 LED-N AT	445	55478	ARK 10/2 LED-N RU	134
54328	BLIK 60 LED-W RU	119	54551	STAR L60 LED-N BI	125	54798	K8 200 LED-N RU	445	55481	ARK 10 MIX LED-W BI	134
54331	BLIK 60 DM LED-W BI	119	54556	STAR L60 LED-N GR	125	54801	ROL 1 LED-W BI	109	55486	ARK 10 MIX LED-W GR	134
54336	BLIK 60 DM LED-W GR	119	54557	STAR L60 LED-N AT	125	54806	ROL 1 LED-W GR	109	55487	ARK 10 MIX LED-W AT	134
54337	BLIK 60 DM LED-W AT	119	54558	STAR L60 LED-N RU	125	54807	ROL 1 LED-W AT	109	55488	ARK 10 MIX LED-W RU	134
54338	BLIK 60 DM LED-W RU	119	54561	STAR L120 LED-W BI	125	54808	ROL 1 LED-W RU	109	55491	ARK 10 MIX LED-N BI	134
54341	BLIK 60 LED-N BI	119	54566	STAR L120 LED-W GR	125	54811	ROL 1 LED-N BI	109	55496	ARK 10 MIX LED-N GR	134
54346	BLIK 60 LED-N GR	119	54567	STAR L120 LED-W AT	125	54816	ROL 1 LED-N GR	109	55497	ARK 10 MIX LED-N AT	134
54347	BLIK 60 LED-N AT	119	54568	STAR L120 LED-W RU	125	54817	ROL 1 LED-N AT	109	55498	ARK 10 MIX LED-N RU	134
54348	BLIK 60 LED-N RU	119	54571	STAR L120 LED-N BI	125	54818	ROL 1 LED-N GR	109	55501	ARK 20 LED-W BI	135
54351	BLIK 60 DM LED-N BI	119	54576	STAR L120 LED-N GR	125	54821	ROL 2 LED-W BI	109	55506	ARK 20 LED-W GR	135
54356	BLIK 60 DM LED-N GR	119	54577	STAR L120 LED-N AT	125	54826	ROL 2 LED-W GR	109	55507	ARK 20 LED-W AT	135
54357	BLIK 60 DM LED-N AT	119	54578	STAR L120 LED-N RU	125	54827	ROL 2 LED-W AT	109	55508	ARK 20 LED-W RU	135
54358	BLIK 60 DM LED-N RU	119	54581	STEP 1 LED-W BI	128	54828	ROL 2 LED-W GR	109	55511	ARK 20 LED-N BI	135
54361	BLIK 120 LED-W BI	119	54586	STEP 1 LED-W GR	128	54831	ROL 2 LED-N BI	109	55516	ARK 20 LED-N GR	135
54366	BLIK 120 LED-W GR	119	54587	STEP 1 LED-W AT	128	54836	ROL 2 LED-N GR	109	55517	ARK 20 LED-N AT	135
54367	BLIK 120 LED-W AT	119	54588	STEP 1 LED-W RU	128	54837	ROL 2 LED-N AT	109	55518	ARK 20 LED-N RU	135
54368	BLIK 120 LED-W RU	119	54591	STEP 1 LED-N BI	128	54838	ROL 2 LED-N GR	109	55521	ARK 20/2 LED-W BI	135
54371	BLIK 120 DM LED-W BI	119	54596	STEP 1 LED-N GR	128	55301	EQUOS 1 LED-N/5° BI	104	55526	ARK 20/2 LED-W GR	135
54376	BLIK 120 DM LED-W GR	119	54597	STEP 1 LED-N AT	128	55306	EQUOS 1 LED-N/5° GR	104	55527	ARK 20/2 LED-W AT	135
54377	BLIK 120 DM LED-W AT	119	54598	STEP 1 LED-N RU	128	55307	EQUOS 1 LED-N/5° AT	104	55528	ARK 20/2 LED-W RU	135
54378	BLIK 120 DM LED-W RU	119	54601	STEP 2 LED-W BI	128	55308	EQUOS 1 LED-N/5° RU	104	55531	ARK 20/2 LED-N BI	135
54381	BLIK 120 LED-N BI	119	54606	STEP 2 LED-W GR	128	55311	EQUOS 1 LED-N/40° BI	104	55536	ARK 20/2 LED-N GR	135
54386	BLIK 120 LED-N GR	119	54607	STEP 2 LED-W AT	128	55316	EQUOS 1 LED-N/40° GR	104	55537	ARK 20/2 LED-N AT	135
54387	BLIK 120 LED-N AT	119	54608	STEP 2 LED-W RU	128	55317	EQUOS 1 LED-N/40° AT	104	55538	ARK 20/2 LED-N RU	135
54388	BLIK 120 LED-N RU	119	54611	STEP 2 LED-N BI	128	55318	EQUOS 1 LED-N/40° RU	104	55541	ARK 20 MIX LED-W BI	135
54391	BLIK 120 DM LED-N BI	119	54616	STEP 2 LED-N GR	128	55321	EQUOS 1 LED-N/120° BI	104	55546	ARK 20 MIX LED-W GR	135

14 applique interni/esterni
wall lights indoor/outdoor

150 plafoniere interni/esterni
ceiling bowls indoor/outdoor

248 testaletto
bed head units

258 sospensioni
suspensions

344 lampade
lamps

384 lampioni ed incassi
bollards & recessed lights

450 indice
index

cod.	articolo/item	pag.	cod.	articolo/item	pag.	cod.	articolo/item	pag.	cod.	articolo/item	pag.
55547	ARK 20 MIX LED-W AT	135	55806	A2 100 LED-N GR	442	56048	INKA 1/90 LED-W RU	399	57897	FARO 70 LED-W AT	416
55548	ARK 20 MIX LED-W RU	135	55807	A2 100 LED-N AT	442	56056	INKA 1/90 LED-N GR	399	57898	FARO 70 LED-W RU	416
55551	ARK 20 MIX LED-N BI	135	55808	A2 100 LED-N RU	442	56057	INKA 1/90 LED-N AT	399	57906	FARO 70 LED-N GR	416
55556	ARK 20 MIX LED-N GR	135	55811	A2 200 LED-W BI	442	56058	INKA 1/90 LED-N RU	399	57907	FARO 70 LED-N AT	416
55557	ARK 20 MIX LED-N AT	135	55816	A2 200 LED-W GR	442	56066	INKA 1/92 LED-W GR	399	57908	FARO 70 LED-N RU	416
55558	ARK 20 MIX LED-N RU	135	55817	A2 200 LED-W AT	442	56067	INKA 1/92 LED-W AT	399	57916	FARO 85 LED-W GR	416
55561	KIT 1 LED-W BI	138	55818	A2 200 LED-W RU	442	56068	INKA 1/92 LED-W RU	399	57917	FARO 85 LED-W AT	416
55566	KIT 1 LED-W GR	138	55821	A2 200 LED-N BI	442	56076	INKA 1/92 LED-N GR	399	57918	FARO 85 LED-W RU	416
55567	KIT 1 LED-W AT	138	55826	A2 200 LED-N GR	442	56077	INKA 1/92 LED-N AT	399	57926	FARO 85 LED-N GR	416
55568	KIT 1 LED-W RU	138	55827	A2 200 LED-N AT	442	56078	INKA 1/92 LED-N RU	399	57927	FARO 85 LED-N AT	416
55571	KIT 1 LED-N BI	138	55828	A2 200 LED-N RU	442	57636	STEP 1/30 LED-W GR	401	57928	FARO 85 LED-N RU	416
55576	KIT 1 LED-N GR	138	55831	A3 100 LED-W BI	443	57637	STEP 1/30 LED-W AT	401	57936	BEST 50 LED-W GR	419
55577	KIT 1 LED-N AT	138	55836	A3 100 LED-W GR	443	57638	STEP 1/30 LED-W RU	401	57937	BEST 50 LED-W AT	419
55578	KIT 1 LED-N RU	138	55837	A3 100 LED-W AT	443	57646	STEP 1/30 LED-N GR	401	57938	BEST 50 LED-W RU	419
55581	KIT 2 LED-W BI	138	55838	A3 100 LED-W RU	443	57647	STEP 1/30 LED-N AT	401	57946	BEST 50 LED-W GR	419
55586	KIT 2 LED-W GR	138	55841	A3 100 LED-N BI	443	57648	STEP 1/30 LED-N RU	401	57947	BEST 50 LED-W AT	419
55587	KIT 2 LED-W AT	138	55846	A3 100 LED-N GR	443	57656	STEP 1/60 LED-W GR	401	57948	BEST 50 LED-W RU	419
55588	KIT 2 LED-W RU	138	55847	A3 100 LED-N AT	443	57657	STEP 1/60 LED-W AT	401	57956	BEST 90 LED-W GR	419
55591	KIT 2 LED-N BI	138	55848	A3 100 LED-N RU	443	57658	STEP 1/60 LED-W RU	401	57957	BEST 90 LED-W AT	419
55596	KIT 2 LED-N GR	138	55851	A3 200 LED-W BI	443	57666	STEP 1/60 LED-N GR	401	57958	BEST 90 LED-W RU	419
55597	KIT 2 LED-N AT	138	55856	A3 200 LED-W GR	443	57667	STEP 1/60 LED-N AT	401	57966	BEST 90 LED-W GR	419
55598	KIT 2 LED-N RU	138	55857	A3 200 LED-W AT	443	57668	STEP 1/60 LED-N RU	401	57967	BEST 90 LED-W AT	419
55606	BAND LED-W GR	143	55858	A3 200 LED-W RU	443	57676	STEP 1/32 LED-W GR	401	57968	BEST 90 LED-W RU	419
55607	BAND LED-W AT	143	55861	A3 200 LED-N BI	443	57677	STEP 1/32 LED-W AT	401	58346	ASSO EL GR	147
55608	BAND LED-W RU	143	55866	A3 200 LED-N GR	443	57678	STEP 1/32 LED-W RU	401	58347	ASSO EL AT	147
55616	BAND LED-N GR	143	55867	A3 200 LED-N AT	443	57686	STEP 1/32 LED-N GR	401	58348	ASSO EL RU	147
55617	BAND LED-N AT	143	55868	A3 200 LED-N RU	443	57687	STEP 1/32 LED-N AT	401	58366	KING EL GR	247
55618	BAND LED-N RU	143	55871	A4 100 LED-W BI	443	57688	STEP 1/32 LED-N RU	401	58367	KING EL AT	247
55626	KROS LED-W GR	145	55876	A4 100 LED-W GR	443	57696	STEP 1/62 LED-W GR	401	58368	KING EL RU	247
55627	KROS LED-W AT	145	55877	A4 100 LED-W AT	443	57697	STEP 1/62 LED-W AT	401	58386	QUEEN EL GR	245
55628	KROS LED-W RU	145	55878	A4 100 LED-W RU	443	57698	STEP 1/62 LED-W RU	401	58387	QUEEN EL AT	245
55636	KROS LED-N GR	145	55881	A4 100 LED-N BI	443	57706	STEP 1/62 LED-N GR	401	58388	QUEEN EL RU	245
55637	KROS LED-N AT	145	55886	A4 100 LED-N GR	443	57707	STEP 1/62 LED-N AT	401	58391	RING 280 EL BI	243
55638	KROS LED-N RU	145	55887	A4 100 LED-N AT	443	57708	STEP 1/62 LED-N RU	401	58396	RING 280 EL GR	243
55656	ASSO LED-W GR	147	55888	A4 100 LED-N RU	443	57716	STEP 2/30 LED-W GR	402	58397	RING 280 EL AT	243
55657	ASSO LED-W AT	147	55891	A4 200 LED-W BI	443	57717	STEP 2/30 LED-W AT	402	58398	RING 280 EL RU	243
55658	ASSO LED-W RU	147	55896	A4 200 LED-W GR	443	57718	STEP 2/30 LED-W RU	402	58401	RING 350 EL BI	243
55666	ASSO LED-N GR	147	55897	A4 200 LED-W AT	443	57726	STEP 2/30 LED-N GR	402	58406	RING 350 EL GR	243
55667	ASSO LED-N AT	147	55898	A4 200 LED-W RU	443	57727	STEP 2/30 LED-N AT	402	58407	RING 350 EL AT	243
55668	ASSO LED-N RU	147	55901	A4 200 LED-N BI	443	57728	STEP 2/30 LED-N RU	402	58408	RING 350 EL RU	243
55676	KING LED-W GR	247	55906	A4 200 LED-N GR	443	57736	STEP 2/60 LED-W GR	402	59006	KIT 1/60 LED-W GR	406
55677	KING LED-W AT	247	55907	A4 200 LED-N AT	443	57737	STEP 2/60 LED-W AT	402	59007	KIT 1/60 LED-W AT	406
55678	KING LED-W RU	247	55908	A4 200 LED-N RU	443	57738	STEP 2/60 LED-W RU	402	59008	KIT 1/60 LED-W RU	406
55686	KING LED-N GR	247	55911	A6 200 LED-W BI	444	57746	STEP 2/60 LED-N GR	402	59016	KIT 1/60 LED-N GR	406
55687	KING LED-N AT	247	55916	A6 200 LED-W GR	444	57747	STEP 2/60 LED-N AT	402	59017	KIT 1/60 LED-N AT	406
55688	KING LED-N RU	247	55917	A6 200 LED-W AT	444	57748	STEP 2/60 LED-N RU	402	59018	KIT 1/60 LED-N RU	406
55696	QUEEN LED-W GR	245	55918	A6 200 LED-W RU	444	57756	STEP 2/32 LED-W GR	402	59026	KIT 1/100 LED-W GR	406
55697	QUEEN LED-W AT	245	55921	A6 200 LED-N BI	444	57757	STEP 2/32 LED-W AT	402	59027	KIT 1/100 LED-W AT	406
55698	QUEEN LED-W RU	245	55926	A6 200 LED-N GR	444	57758	STEP 2/32 LED-W RU	402	59028	KIT 1/100 LED-W RU	406
55706	QUEEN LED-N GR	245	55927	A6 200 LED-N AT	444	57766	STEP 2/32 LED-N GR	402	59036	KIT 1/100 LED-N GR	406
55707	QUEEN LED-N AT	245	55928	A6 200 LED-N RU	444	57767	STEP 2/32 LED-N AT	402	59037	KIT 1/100 LED-N AT	406
55708	QUEEN LED-N RU	245	55931	A7 200 LED-W BI	444	57768	STEP 2/32 LED-N RU	402	59038	KIT 1/100 LED-N RU	406
55711	RING 280 LED-W BI	243	55936	A7 200 LED-W GR	444	57776	STEP 2/62 LED-W GR	402	59046	KIT 1/62 LED-W GR	406
55716	RING 280 LED-W GR	243	55937	A7 200 LED-W AT	444	57777	STEP 2/62 LED-W AT	402	59047	KIT 1/62 LED-W AT	406
55717	RING 280 LED-W AT	243	55938	A7 200 LED-W RU	444	57778	STEP 2/62 LED-W RU	402	59048	KIT 1/62 LED-W RU	406
55718	RING 280 LED-W RU	243	55941	A7 200 LED-N BI	444	57786	STEP 2/62 LED-N GR	402	59056	KIT 1/62 LED-N GR	406
55721	RING 280 LED-N BI	243	55946	A7 200 LED-N GR	444	57787	STEP 2/62 LED-N AT	402	59057	KIT 1/62 LED-N AT	406
55726	RING 280 LED-N GR	243	55947	A7 200 LED-N AT	444	57788	STEP 2/62 LED-N RU	402	59058	KIT 1/62 LED-N RU	406
55727	RING 280 LED-N AT	243	55948	A7 200 LED-N RU	444	57796	STEP 3/30 LED-W GR	403	59066	KIT 1/102 LED-W GR	406
55728	RING 280 LED-N RU	243	55951	A8 200 LED-W BI	444	57797	STEP 3/30 LED-W AT	403	59067	KIT 1/102 LED-W AT	406
55731	RING 350 LED-W BI	243	55956	A8 200 LED-W GR	444	57798	STEP 3/30 LED-W RU	403	59068	KIT 1/102 LED-W RU	406
55736	RING 350 LED-W GR	243	55957	A8 200 LED-W AT	444	57806	STEP 3/30 LED-N GR	403	59076	KIT 1/102 LED-N GR	406
55737	RING 350 LED-W AT	243	55958	A8 200 LED-W RU	444	57807	STEP 3/30 LED-N AT	403	59077	KIT 1/102 LED-N AT	406
55738	RING 350 LED-W RU	243	55961	A8 200 LED-N BI	444	57808	STEP 3/30 LED-N RU	403	59078	KIT 1/102 LED-N RU	406
55741	RING 350 LED-N BI	243	55966	A8 200 LED-N GR	444	57816	STEP 3/60 LED-W GR	403	59086	KIT 2/60 LED-W GR	407
55746	RING 350 LED-N GR	243	55967	A8 200 LED-N AT	444	57817	STEP 3/60 LED-W AT	403	59087	KIT 2/60 LED-W AT	407
55747	RING 350 LED-N AT	243	55968	A8 200 LED-N RU	444	57818	STEP 3/60 LED-W RU	403	59088	KIT 2/60 LED-W RU	407
55748	RING 350 LED-N RU	243	55971	NANO APS LED-W BI	131	57826	STEP 3/60 LED-N GR	403	59096	KIT 2/60 LED-N GR	407
55751	A1 100 LED-W BI	442	55976	NANO APS LED-W GR	131	57827	STEP 3/60 LED-N AT	403	59097	KIT 2/60 LED-N AT	407
55756	A1 100 LED-W GR	442	55977	NANO APS LED-W AT	131	57828	STEP 3/60 LED-N RU	403	59098	KIT 2/60 LED-N RU	407
55757	A1 100 LED-W AT	442	55978	NANO APS LED-W RU	131	57836	STEP 3/32 LED-W GR	403	59106	KIT 2/100 LED-W GR	407
55758	A1 100 LED-W RU	442	55981	NANO APS LED-N BI	131	57837	STEP 3/32 LED-W AT	403	59107	KIT 2/100 LED-W AT	407
55761	A1 100 LED-N BI	442	55986	NANO APS LED-N GR	131	57838	STEP 3/32 LED-W RU	403	59108	KIT 2/100 LED-W RU	407
55766	A1 100 LED-N GR	442	55987	NANO APS LED-N AT	131	57846	STEP 3/32 LED-N GR	403	59116	KIT 2/100 LED-N GR	407
55767	A1 100 LED-N AT	442	55988	NANO APS LED-N RU	131	57847	STEP 3/32 LED-N AT	403	59117	KIT 2/100 LED-N AT	407
55768	A1 100 LED-N RU	442	56006	INKA 1/60 LED-W GR	399	57848	STEP 3/32 LED-N RU	403	59118	KIT 2/100 LED-N RU	407
55771	A1 200 LED-W BI	442	56007	INKA 1/60 LED-W AT	399	57856	STEP 3/62 LED-W GR	403	59126	KIT 2/62 LED-W GR	407
55776	A1 200 LED-W GR	442	56008	INKA 1/60 LED-W RU	399	57857	STEP 3/62 LED-W AT	403	59127	KIT 2/62 LED-W AT	407
55777	A1 200 LED-W AT	442	56016	INKA 1/60 LED-N GR	399	57858	STEP 3/62 LED-W RU	403	59128	KIT 2/62 LED-W RU	407
55778	A1 200 LED-W RU	442	56017	INKA 1/60 LED-N AT	399	57866	STEP 3/62 LED-N GR	403	59136	KIT 2/62 LED-N GR	407
55781	A1 200 LED-N BI	442	56018	INKA 1/60 LED-N GR	399	57867	STEP 3/62 LED-N AT	403	59137	KIT 2/62 LED-N AT	407
55786	A1 200 LED-N GR	442	56026	INKA 1/62 LED-W GR	399	57868	STEP 3/62 LED-N RU	403	59138	KIT 2/62 LED-N RU	407
55787	A1 200 LED-N AT	442	56027	INKA 1/62 LED-W AT	399	57876	FARO 50 LED-W GR	416	59146	KIT 2/102 LED-W GR	407
55788	A1 200 LED-N RU	442	56028	INKA 1/62 LED-W RU	399	57877	FARO 50 LED-W AT	416	59147	KIT 2/102 LED-W AT	407
55791	A2 100 LED-W BI	442	56036	INKA 1/62 LED-N GR	399	57878	FARO 50 LED-W RU	416	59148	KIT 2/102 LED-W RU	407
55796	A2 100 LED-W GR	442	56037	INKA 1/62 LED-N AT	399	57886	FARO 50 LED-N GR	416	59156	KIT 2/102 LED-N GR	407
55797	A2 100 LED-W AT	442	56038	INKA 1/62 LED-N RU	399	57887	FARO 50 LED-N AT	416	59157	KIT 2/102 LED-N AT	407
55798	A2 100 LED-W RU	442	56046	INKA 1/90 LED-W GR	399	57888	FARO 50 LED-N RU	416	59158	KIT 2/102 LED-N RU	407
55801	A2 100 LED-N BI	442	56047	INKA 1/90 LED-W AT	399	57896	FARO 70 LED-W GR	416	59166	NANO 12 LED-W GR	409

cod.	articolo/item	pag.	cod.	articolo/item	pag.	cod.	articolo/item	pag.	cod.	articolo/item	pag.
59167	NANO 12 LED-W AT	409	59437	PLAZA 182 LED-N AT	430	59736	BOX 150BS LED-W GR	437	60151	EQUOS 1 EM BI	106
59168	NANO 12 LED-W RU	409	59438	PLAZA 182 LED-N RU	430	59737	BOX 150BS LED-W AT	437	60156	EQUOS 1 EM GR	106
59176	NANO 12 LED-N GR	409	59446	BOX 30A LED-W GR	434	59738	BOX 150BS LED-W RU	437	60157	EQUOS 1 EM AT	106
59177	NANO 12 LED-N AT	409	59447	BOX 30A LED-W AT	434	59746	BOX 150B LED-N GR	437	60158	EQUOS 1 EM RU	106
59178	NANO 12 LED-N RU	409	59448	BOX 30A LED-W RU	434	59747	BOX 150B LED-N AT	437	60161	EQUOS 2 EM BI	107
59186	NANO 35 LED-W GR	409	59456	BOX 30A LED-N GR	434	59748	BOX 150B LED-N RU	437	60166	EQUOS 2 EM GR	107
59187	NANO 35 LED-W AT	409	59457	BOX 30A LED-N AT	434	59756	BOX 150BS LED-N GR	437	60167	EQUOS 2 EM AT	107
59188	NANO 35 LED-W RU	409	59458	BOX 30A LED-N RU	434	59757	BOX 150BS LED-N AT	437	60168	EQUOS 2 EM RU	107
59196	NANO 35 LED-N GR	409	59466	BOX 30B LED-W GR	434	59758	BOX 150BS LED-N RU	437	60171	BLIK 60 EM/72 BI	119
59197	NANO 35 LED-N AT	409	59467	BOX 30B LED-W AT	434	59766	BOX 150C LED-W GR	437	60176	BLIK 60 EM/72 GR	119
59198	NANO 35 LED-N RU	409	59468	BOX 30B LED-W RU	434	59767	BOX 150C LED-W AT	437	60177	BLIK 60 EM/72 AT	119
59201	B4 200 LED-W BI	448	59476	BOX 30B LED-N GR	434	59768	BOX 150C LED-W RU	437	60178	BLIK 60 EM/72 RU	119
59206	B4 200 LED-W GR	448	59477	BOX 30B LED-N AT	434	59776	BOX 150CS LED-W GR	437	60181	PLAN 60 EM/72 BI	113
59207	B4 200 LED-W AT	448	59478	BOX 30B LED-N RU	434	59777	BOX 150CS LED-W AT	437	60186	PLAN 60 EM/72 GR	113
59208	B4 200 LED-W RU	448	59486	BOX 30C LED-W GR	434	59778	BOX 150CS LED-W RU	437	60187	PLAN 60 EM/72 AT	113
59211	B4 200 LED-N BI	448	59487	BOX 30C LED-W AT	434	59786	BOX 150C LED-N GR	437	60188	PLAN 60 EM/72 RU	113
59216	B4 200 LED-N GR	448	59488	BOX 30C LED-W RU	434	59787	BOX 150C LED-N AT	437	60191	STAR C60 EM/72 BI	123
59217	B4 200 LED-N AT	448	59496	BOX 30C LED-N GR	434	59788	BOX 150C LED-N RU	437	60196	STAR C60 EM/72 GR	123
59218	B4 200 LED-N RU	448	59497	BOX 30C LED-N AT	434	59796	BOX 150CS LED-N GR	437	60197	STAR C60 EM/72 AT	123
59221	B4 200/2 LED-W BI	448	59498	BOX 30C LED-N RU	434	59797	BOX 150CS LED-N AT	437	60198	STAR C60 EM/72 RU	123
59226	B4 200/2 LED-W GR	448	59506	BOX 60A LED-W GR	435	59798	BOX 150CS LED-N RU	437	60201	STAR L60 EM/72 BI	125
59227	B4 200/2 LED-W AT	448	59507	BOX 60A LED-W AT	435	59806	POLO 60 LED-W GR	439	60206	STAR L60 EM/72 GR	125
59228	B4 200/2 LED-W RU	448	59508	BOX 60A LED-W RU	435	59807	POLO 60 LED-W AT	439	60207	STAR L60 EM/72 AT	125
59231	B4 200/2 LED-N BI	448	59516	BOX 60A LED-N GR	435	59808	POLO 60 LED-W RU	439	60208	STAR L60 EM/72 RU	125
59236	B4 200/2 LED-N GR	448	59517	BOX 60A LED-N AT	435	59816	POLO 60 LED-N GR	439	60311	COVER EM RU-TR	141
59237	B4 200/2 LED-N AT	448	59518	BOX 60A LED-N RU	435	59817	POLO 60 LED-N AT	439	61241	B4 200 BI	448
59238	B4 200/2 LED-N RU	448	59526	BOX 60B LED-W GR	435	59818	POLO 60 LED-N RU	439	61246	B4 200 GR	448
59241	B8 200 LED-W BI	449	59527	BOX 60B LED-W AT	435	59826	POLO 62 LED-W GR	439	61247	B4 200 AT	448
59246	B8 200 LED-W GR	449	59528	BOX 60B LED-W RU	435	59827	POLO 62 LED-W AT	439	61248	B4 200 RU	448
59247	B8 200 LED-W AT	449	59536	BOX 60B LED-N GR	435	59828	POLO 62 LED-W RU	439	61251	B4 200/2 BI	448
59248	B8 200 LED-W RU	449	59537	BOX 60B LED-N AT	435	59836	POLO 62 LED-N GR	439	61256	B4 200/2 GR	448
59251	B8 200 LED-N BI	449	59538	BOX 60B LED-N RU	435	59837	POLO 62 LED-N AT	439	61257	B4 200/2 AT	448
59256	B8 200 LED-N GR	449	59546	BOX 60C LED-W GR	435	59838	POLO 62 LED-N RU	439	61258	B4 200/2 RU	448
59257	B8 200 LED-N AT	449	59547	BOX 60C LED-W AT	435	59846	POLO 100 LED-W GR	439	61261	B8 200 BI	449
59258	B8 200 LED-N RU	449	59548	BOX 60C LED-W RU	435	59847	POLO 100 LED-W AT	439	61266	B8 200 GR	449
59261	B8 200/2 LED-W BI	449	59556	BOX 60C LED-N GR	435	59848	POLO 100 LED-W RU	439	61267	B8 200 AT	449
59266	B8 200/2 LED-W GR	449	59557	BOX 60C LED-N AT	435	59856	POLO 100 LED-N GR	439	61268	B8 200 RU	449
59267	B8 200/2 LED-W AT	449	59558	BOX 60C LED-N RU	435	59857	POLO 100 LED-N AT	439	61271	B8 200/2 BI	449
59268	B8 200/2 LED-W RU	449	59566	BOX 120A LED-W GR	436	59858	POLO 100 LED-N RU	439	61276	B8 200/2 GR	449
59271	B8 200/2 LED-N BI	449	59567	BOX 120A LED-W AT	436	59866	POLO 102 LED-W GR	439	61277	B8 200/2 AT	449
59276	B8 200/2 LED-N GR	449	59568	BOX 120A LED-W RU	436	59867	POLO 102 LED-W AT	439	61278	B8 200/2 RU	449
59277	B8 200/2 LED-N AT	449	59576	BOX 120AS LED-W GR	436	59868	POLO 102 LED-W RU	439	61301	K4 100 BI	445
59278	B8 200/2 LED-N RU	449	59577	BOX 120AS LED-W AT	436	59876	POLO 102 LED-N GR	439	61306	K4 100 GR	445
59286	PARK 90 LED-W GR	426	59578	BOX 120AS LED-W RU	436	59877	POLO 102 LED-N AT	439	61307	K4 100 AT	445
59287	PARK 90 LED-W AT	426	59586	BOX 120A LED-N GR	436	59878	POLO 102 LED-N RU	439	61308	K4 100 RU	445
59288	PARK 90 LED-W RU	426	59587	BOX 120A LED-N AT	436	59886	KUBA 60 LED-W GR	393	61311	K4 200 BI	445
59296	PARK 90 LED-N GR	426	59588	BOX 120A LED-N RU	436	59887	KUBA 60 LED-W AT	393	61316	K4 200 GR	445
59297	PARK 90 LED-N AT	426	59596	BOX 120AS LED-N GR	436	59888	KUBA 60 LED-W RU	393	61317	K4 200 AT	445
59298	PARK 90 LED-N RU	426	59597	BOX 120AS LED-N AT	436	59896	KUBA 60 LED-N GR	393	61318	K4 200 RU	445
59306	PARK 180 LED-W GR	426	59598	BOX 120AS LED-N RU	436	59897	KUBA 60 LED-N AT	393	61321	K8 200 BI	445
59307	PARK 180 LED-W AT	426	59606	BOX 120B LED-W GR	436	59898	KUBA 60 LED-N RU	393	61326	K8 200 GR	445
59308	PARK 180 LED-W RU	426	59607	BOX 120B LED-W AT	436	59906	KUBA 90 LED-W GR	393	61327	K8 200 AT	445
59316	PARK 180 LED-N GR	426	59608	BOX 120B LED-W RU	436	59907	KUBA 90 LED-W AT	393	61328	K8 200 RU	445
59317	PARK 180 LED-N AT	426	59616	BOX 120BS LED-W GR	436	59908	KUBA 90 LED-W RU	393	61746	POLO GR	149
59318	PARK 180 LED-N RU	426	59617	BOX 120BS LED-W AT	436	59916	KUBA 90 LED-N GR	393	61747	POLO AT	149
59326	PARK 92 LED-W GR	426	59618	BOX 120BS LED-W RU	436	59917	KUBA 90 LED-N AT	393	61748	POLO RU	149
59327	PARK 92 LED-W AT	426	59626	BOX 120B LED-N GR	436	59918	KUBA 90 LED-N RU	393	61756	RIGA GR	149
59328	PARK 92 LED-W RU	426	59627	BOX 120B LED-N AT	436	59926	PALOLED 60 LED-W GR	389	61757	RIGA AT	149
59336	PARK 92 LED-N GR	426	59628	BOX 120B LED-N RU	436	59927	PALOLED 60 LED-W AT	389	61758	RIGA RU	149
59337	PARK 92 LED-N AT	426	59636	BOX 120BS LED-N GR	436	59928	PALOLED 60 LED-W RU	389	62001	BLIK 30 BI	118
59338	PARK 92 LED-N RU	426	59637	BOX 120BS LED-N AT	436	59936	PALOLED 60 LED-N GR	389	62006	BLIK 30 GR	118
59346	PARK 182 LED-W GR	426	59638	BOX 120BS LED-N RU	436	59937	PALOLED 60 LED-N AT	389	62007	BLIK 30 AT	118
59347	PARK 182 LED-W AT	426	59646	BOX 120C LED-W GR	436	59938	PALOLED 60 LED-N RU	389	62008	BLIK 30 RU	118
59348	PARK 182 LED-W RU	426	59647	BOX 120C LED-W AT	436	59946	PALOLED 62 LED-W GR	389	62011	PLAN 30 BI	112
59356	PARK 182 LED-N GR	426	59648	BOX 120C LED-W RU	436	59947	PALOLED 62 LED-W AT	389	62016	PLAN 30 GR	112
59357	PARK 182 LED-N AT	426	59656	BOX 120CS LED-W GR	436	59948	PALOLED 62 LED-W RU	389	62017	PLAN 30 AT	112
59358	PARK 182 LED-N RU	426	59657	BOX 120CS LED-W AT	436	59956	PALOLED 62 LED-N GR	389	62018	PLAN 30 RU	112
59366	PLAZA 90 LED-W GR	430	59658	BOX 120CS LED-W RU	436	59957	PALOLED 62 LED-N AT	389	62091	COVER AT-TR	141
59367	PLAZA 90 LED-W AT	430	59666	BOX 120C LED-N GR	436	59958	PALOLED 62 LED-N RU	389	62092	COVER AT-GI	141
59368	PLAZA 90 LED-W RU	430	59667	BOX 120C LED-N AT	436	59966	PALOLED 110 LED-W GR	389	62093	COVER AT-RO	141
59376	PLAZA 90 LED-N GR	430	59668	BOX 120C LED-N RU	436	59967	PALOLED 110 LED-W AT	389	62095	COVER AT-BL	141
59377	PLAZA 90 LED-N AT	430	59676	BOX 120CS LED-N GR	436	59968	PALOLED 110 LED-W RU	389	62101	COVER GR-TR	141
59378	PLAZA 90 LED-N RU	430	59677	BOX 120CS LED-N AT	436	59976	PALOLED 110 LED-N GR	389	62102	COVER GR-GI	141
59386	PLAZA 180 LED-W GR	430	59678	BOX 120CS LED-N RU	436	59977	PALOLED 110 LED-N AT	389	62103	COVER GR-RO	141
59387	PLAZA 180 LED-W AT	430	59686	BOX 150A LED-W GR	437	59978	PALOLED 110 LED-N RU	389	62105	COVER GR-BL	141
59388	PLAZA 180 LED-W RU	430	59687	BOX 150A LED-W AT	437	59986	PALOLED 112 LED-W GR	389	62121	STAR C30 BI	122
59396	PLAZA 180 LED-N GR	430	59688	BOX 150A LED-W RU	437	59987	PALOLED 112 LED-W AT	389	62126	STAR C30 GR	122
59397	PLAZA 180 LED-N AT	430	59696	BOX 150AS LED-W GR	437	59988	PALOLED 112 LED-W RU	389	62127	STAR C30 AT	122
59398	PLAZA 180 LED-N RU	430	59697	BOX 150AS LED-W AT	437	59996	PALOLED 112 LED-N GR	389	62128	STAR C30 RU	122
59406	PLAZA 92 LED-W GR	430	59698	BOX 150AS LED-W RU	437	59997	PALOLED 112 LED-N AT	389	62131	STAR L30 BI	125
59407	PLAZA 92 LED-W AT	430	59706	BOX 150A LED-N GR	437	59998	PALOLED 112 LED-N RU	389	62136	STAR L30 GR	125
59408	PLAZA 92 LED-W RU	430	59707	BOX 150A LED-N AT	437	60041	COVER EM AT-TR	141	62137	STAR L30 AT	125
59416	PLAZA 92 LED-N GR	430	59708	BOX 150A LED-N RU	437	60042	COVER EM AT-GI	141	62138	STAR L30 RU	125
59417	PLAZA 92 LED-N AT	430	59716	BOX 150AS LED-N GR	437	60043	COVER EM AT-RO	141	62161	KIT 1 BI	138
59418	PLAZA 92 LED-N RU	430	59717	BOX 150AS LED-N AT	437	60045	COVER EM AT-BL	141	62166	KIT 1 GR	138
59426	PLAZA 182 LED-W GR	430	59718	BOX 150AS LED-N RU	437	60051	COVER EM GR-TR	141	62167	KIT 1 AT	138
59427	PLAZA 182 LED-W AT	430	59726	BOX 150B LED-W GR	437	60052	COVER EM GR-GI	141	62168	KIT 1 RU	138
59428	PLAZA 182 LED-W RU	430	59727	BOX 150B LED-W AT	437	60053	COVER EM GR-RO	141	62171	KIT 2 BI	138
59436	PLAZA 182 LED-N GR	430	59728	BOX 150B LED-W RU	437	60055	COVER EM GR-BL	141	62176	KIT 2 GR	138

14 applique interni/esterni
wall lights indoor/outdoor

150 plafoniere interni/esterni
ceiling bowls indoor/outdoor

248 testaletto
bed head units

258 sospensioni
suspensions

344 lampade
lamps

384 lampioni ed incassi
bollards & recessed lights

450 indice
index

cod.	articolo/item	pag.	cod.	articolo/item	pag.	cod.	articolo/item	pag.	cod.	articolo/item	pag.
62177	KIT 2 AT	138	64037	STAR C120/2X54 EL AT	123	64518	EQUOS MIX 70 MD-EL RU	107	65327	KIT 2/102 AT	407
62178	KIT 2 RU	138	64038	STAR C120/2X54 EL RU	123	64521	EQUOS 2/2X35 MD-EL BI	107	65328	KIT 2/102 RU	407
62181	BLIK 20 BI	118	64071	STAR L120/2X54 EL BI	125	64526	EQUOS 2/2X35 MD-EL GR	107	65336	LAND 50 GR	421
62186	BLIK 20 GR	118	64076	STAR L120/2X54 EL GR	125	64527	EQUOS 2/2X35 MD-EL AT	107	65337	LAND 50 AT	421
62187	BLIK 20 AT	118	64077	STAR L120/2X54 EL AT	125	64528	EQUOS 2/2X35 MD-EL RU	107	65338	LAND 50 RU	421
62188	BLIK 20 RU	118	64078	STAR L120/2X54 EL RU	125	64531	EQUOS 2/2X70 MD-EL BI	107	65346	BEST 50 GR	419
62191	PLAN 20 BI	112	64091	BLIK 20 EL BI	118	64536	EQUOS 2/2X70 MD-EL GR	107	65347	BEST 50 AT	419
62196	PLAN 20 GR	112	64096	BLIK 20 EL GR	118	64537	EQUOS 2/2X70 MD-EL AT	107	65348	BEST 50 RU	419
62197	PLAN 20 AT	112	64097	BLIK 20 EL AT	118	64538	EQUOS 2/2X70 MD-EL RU	107	65356	LAND 90 GR	421
62198	PLAN 20 RU	112	64098	BLIK 20 EL RU	118	64541	EQUOS 2/2X150 MD-EL BI	107	65357	LAND 90 AT	421
62211	STAR C20 BI	122	64121	BIPLAN 60/3X24 EL BI	115	64546	EQUOS 2/2X150 MD-EL GR	107	65358	LAND 90 RU	421
62216	STAR C20 GR	122	64126	BIPLAN 60/3X24 EL GR	115	64547	EQUOS 2/2X150 MD-EL AT	107	65366	BEST 90 GR	419
62217	STAR C20 AT	122	64127	BIPLAN 60/3X24 EL AT	115	64548	EQUOS 2/2X150 MD-EL RU	107	65367	BEST 90 AT	419
62218	STAR C20 RU	122	64128	BIPLAN 60/3X24 EL RU	115	64551	PLAN 30/2X42 DM BI	112	65368	BEST 90 RU	419
62231	COVER RU-TR	141	64131	EQUOS 1/26 EL BI	106	64556	PLAN 30/2X42 DM GR	112	65376	PARK 90 GR	426
63081	BLIK 60/2X24 EL BI	119	64136	EQUOS 1/26 EL GR	106	64557	PLAN 30/2X42 DM AT	112	65377	PARK 90 AT	426
63086	BLIK 60/2X24 EL GR	119	64137	EQUOS 1/26 EL AT	106	64558	PLAN 30/2X42 DM RU	112	65378	PARK 90 RU	426
63087	BLIK 60/2X24 EL AT	119	64138	EQUOS 1/26 EL RU	106	64561	PLAN 60/2X36 DM BI	113	65386	PARK 92 GR	426
63088	BLIK 60/2X24 EL RU	119	64141	EQUOS 1/42 EL BI	106	64566	PLAN 60/2X36 DM GR	113	65387	PARK 92 AT	426
63101	BLIK 60/2x55 EL BI	119	64146	EQUOS 1/42 EL GR	106	64567	PLAN 60/2X36 DM AT	113	65388	PARK 92 RU	426
63106	BLIK 60/2x55 EL GR	119	64147	EQUOS 1/42 EL AT	106	64568	PLAN 60/2X36 DM RU	113	65396	PARK 180 GR	426
63107	BLIK 60/2x55 EL AT	119	64148	EQUOS 1/42 EL RU	106	64571	PLAN 60/2X55 DM BI	113	65397	PARK 180 AT	426
63108	BLIK 60/2x55 EL RU	119	64151	EQUOS 1/42 EL LONG BI	106	64576	PLAN 60/2X55 DM GR	113	65398	PARK 180 RU	426
63141	BLIK 120/2x54 EL BI	119	64156	EQUOS 1/42 EL LONG GR	106	64577	PLAN 60/2X55 DM AT	113	65406	PARK 182 GR	426
63146	BLIK 120/2x54 EL GR	119	64157	EQUOS 1/42 EL LONG AT	106	64578	PLAN 60/2X55 DM RU	113	65407	PARK 182 AT	426
63147	BLIK 120/2x54 EL AT	119	64158	EQUOS 1/42 EL LONG RU	106	64581	PLAN 120/2x54 DM BI	113	65408	PARK 182 RU	426
63148	BLIK 120/2x54 EL RU	119	64161	EQUOS 2/2X42 EL BI	107	64586	PLAN 120/2x54 DM GR	113	65416	PLAZA 90 GR	430
63231	PLAN 60/2X24 EL BI	113	64166	EQUOS 2/2X42 EL GR	107	64587	PLAN 120/2x54 DM AT	113	65417	PLAZA 90 AT	430
63236	PLAN 60/2X24 EL GR	113	64167	EQUOS 2/2X42 EL AT	107	64588	PLAN 120/2x54 DM RU	113	65418	PLAZA 90 RU	430
63237	PLAN 60/2X24 EL AT	113	64168	EQUOS 2/2X42 EL RU	107	64591	BLIK 30/2X42 DM BI	118	65426	PLAZA 92 GR	430
63238	PLAN 60/2X24 EL RU	113	64181	BIPLAN 30/3X18 EL BI	115	64596	BLIK 30/2X42 DM GR	118	65427	PLAZA 92 AT	430
63251	PLAN 60/2X55 EL BI	113	64186	BIPLAN 30/3X18 EL GR	115	64597	BLIK 30/2X42 DM AT	118	65428	PLAZA 92 RU	430
63256	PLAN 60/2X55 EL GR	113	64187	BIPLAN 30/3X18 EL AT	115	64598	BLIK 30/2X42 DM RU	118	65436	PLAZA 180 GR	430
63257	PLAN 60/2X55 EL AT	113	64188	BIPLAN 30/3X18 EL RU	115	64601	BLIK 60/2X36 DM BI	119	65437	PLAZA 180 AT	430
63258	PLAN 60/2X55 EL RU	113	64261	BLIK 60/2X36 EL BI	119	64606	BLIK 60/2X36 DM GR	119	65438	PLAZA 180 RU	430
63291	PLAN 120/2x54 EL BI	113	64266	BLIK 60/2X36 EL GR	119	64607	BLIK 60/2X36 DM AT	119	65446	PLAZA 182 GR	430
63296	PLAN 120/2x54 EL GR	113	64267	BLIK 60/2X36 EL AT	119	64608	BLIK 60/2X36 DM RU	119	65447	PLAZA 182 AT	430
63297	PLAN 120/2x54 EL AT	113	64268	BLIK 60/2X36 EL RU	119	64611	BLIK 60/2X55 DM BI	119	65448	PLAZA 182 RU	430
63298	PLAN 120/2x54 EL RU	113	64281	PLAN 20 EL BI	112	64616	BLIK 60/2X55 DM GR	119	66146	BOX 60A/2X24 EL GR	435
63411	COVER EL AT-TR	141	64286	PLAN 20 EL GR	112	64617	BLIK 60/2X55 DM AT	119	66147	BOX 60A/2X24 EL AT	435
63412	COVER EL AT-GI	141	64287	PLAN 20 EL AT	112	64618	BLIK 60/2X55 DM RU	119	66148	BOX 60A/2X24 EL RU	435
63413	COVER EL AT-RO	141	64288	PLAN 20 EL RU	112	64621	BLIK 120/2x54 DM BI	119	66206	BOX 60B/2X24 EL GR	435
63415	COVER EL AT-BL	141	64311	PLAN 60/2X36 EL BI	113	64626	BLIK 120/2x54 DM GR	119	66207	BOX 60B/2X24 EL AT	435
63421	COVER EL GR-TR	141	64316	PLAN 60/2X36 EL GR	113	64627	BLIK 120/2x54 DM AT	119	66208	BOX 60B/2X24 EL RU	435
63422	COVER EL GR-GI	141	64317	PLAN 60/2X36 EL AT	113	64628	BLIK 120/2x54 DM RU	119	66266	BOX 60C/2X24 EL GR	435
63423	COVER EL GR-RO	141	64318	PLAN 60/2X36 EL RU	113	64631	COVER EL RU-TR	141	66267	BOX 60C/2X24 EL AT	435
63425	COVER EL GR-BL	141	64351	STAR C20 EL BI	122	65006	BOX 30A GR	434	66268	BOX 60C/2X24 EL RU	435
63651	BLIK 30/2X42 EL BI	118	64356	STAR C20 EL GR	122	65007	BOX 30A AT	434	66306	BOX 120A/2X54 EL GR	436
63656	BLIK 30/2X42 EL GR	118	64357	STAR C20 EL AT	122	65008	BOX 30A RU	434	66307	BOX 120A/2X54 EL AT	436
63657	BLIK 30/2X42 EL AT	118	64358	STAR C20 EL RU	122	65016	BOX 30B GR	434	66308	BOX 120A/2X54 EL RU	436
63658	BLIK 30/2X42 EL RU	118	64381	STAR C60/2X36 EL BI	123	65017	BOX 30B AT	434	66346	BOX 120B/2X54 EL GR	436
63661	PLAN 30/2X42 EL BI	112	64386	STAR C60/2X36 EL GR	123	65018	BOX 30B RU	434	66347	BOX 120B/2X54 EL AT	436
63666	PLAN 30/2X42 EL GR	112	64387	STAR C60/2X36 EL AT	123	65026	BOX 30C GR	434	66348	BOX 120B/2X54 EL RU	436
63667	PLAN 30/2X42 EL AT	112	64388	STAR C60/2X36 EL RU	123	65027	BOX 30C AT	434	66386	BOX 120C/2X54 EL GR	436
63668	PLAN 30/2X42 EL RU	112	64411	STAR L60/2X36 EL BI	125	65028	BOX 30C RU	434	66387	BOX 120C/2X54 EL AT	436
63701	STAR C30/2X42 EL BI	122	64416	STAR L60/2X36 EL GR	125	65216	POLO 60 GR	439	66388	BOX 120C/2X54 EL RU	436
63706	STAR C30/2X42 EL GR	122	64417	STAR L60/2X36 EL AT	125	65217	POLO 60 AT	439	66426	BOX 150A/2X80 EL GR	437
63707	STAR C30/2X42 EL AT	122	64418	STAR L60/2X36 EL RU	125	65218	POLO 60 RU	439	66427	BOX 150A/2X80 EL AT	437
63708	STAR C30/2X42 EL RU	122	64441	EQUOS 1L/35 MD-EL BI	106	65226	POLO 62 GR	439	66428	BOX 150A/2X80 EL RU	437
63761	STAR C60/2X24 EL BI	123	64446	EQUOS 1L/35 MD-EL GR	106	65227	POLO 62 AT	439	66466	BOX 150B/2X80 EL GR	437
63766	STAR C60/2X24 EL GR	123	64447	EQUOS 1L/35 MD-EL AT	106	65228	POLO 62 RU	439	66467	BOX 150B/2X80 EL AT	437
63767	STAR C60/2X24 EL AT	123	64448	EQUOS 1L/35 MD-EL RU	106	65236	POLO 100 GR	439	66468	BOX 150B/2X80 EL RU	437
63768	STAR C60/2X24 EL RU	123	64451	EQUOS 1/35 MD-EL BI	106	65237	POLO 100 AT	439	66506	BOX 150C/2X80 EL GR	437
63771	STAR C60/2X55 EL BI	123	64456	EQUOS 1/35 MD-EL GR	106	65238	POLO 100 RU	439	66507	BOX 150C/2X80 EL AT	437
63776	STAR C60/2X55 EL GR	123	64457	EQUOS 1/35 MD-EL AT	106	65246	POLO 102 GR	439	66508	BOX 150C/2X80 EL RU	437
63777	STAR C60/2X55 EL AT	123	64458	EQUOS 1/35 MD-EL RU	106	65247	POLO 102 AT	439	66926	KIT 1/60 EL GR	406
63778	STAR C60/2X55 EL RU	123	64461	EQUOS 1/70 MD-EL BI	106	65248	POLO 102 RU	439	66927	KIT 1/60 EL AT	406
63811	STAR L30/2X42 EL BI	125	64466	EQUOS 1/70 MD-EL GR	106	65256	KIT 1/60 GR	406	66928	KIT 1/60 EL RU	406
63816	STAR L30/2X42 EL GR	125	64467	EQUOS 1/70 MD-EL AT	106	65257	KIT 1/60 AT	406	66946	KIT 1/100 EL GR	406
63817	STAR L30/2X42 EL AT	125	64468	EQUOS 1/70 MD-EL RU	106	65258	KIT 1/60 RU	406	66947	KIT 1/100 EL AT	406
63818	STAR L30/2X42 EL RU	125	64471	EQUOS 1/150 MD-EL BI	106	65266	KIT 1/100 GR	406	66948	KIT 1/100 EL RU	406
63871	STAR L60/2X24 EL BI	125	64476	EQUOS 1/150 MD-EL GR	106	65267	KIT 1/100 AT	406	66966	KIT 1/62 EL GR	406
63876	STAR L60/2X24 EL GR	125	64477	EQUOS 1/150 MD-EL AT	106	65268	KIT 1/100 RU	406	66967	KIT 1/62 EL AT	406
63877	STAR L60/2X24 EL AT	125	64478	EQUOS 1/150 MD-EL RU	106	65276	KIT 1/62 GR	406	66968	KIT 1/62 EL RU	406
63878	STAR L60/2X24 EL RU	125	64481	EQUOS 2L/35 MD-EL BI	107	65277	KIT 1/62 AT	406	66986	KIT 1/102 EL GR	406
63881	STAR L60/2X55 EL BI	125	64486	EQUOS 2L/35 MD-EL GR	107	65278	KIT 1/62 RU	406	66987	KIT 1/102 EL AT	406
63886	STAR L60/2X55 EL GR	125	64487	EQUOS 2L/35 MD-EL AT	107	65286	KIT 1/102 GR	406	66988	KIT 1/102 EL RU	406
63887	STAR L60/2X55 EL AT	125	64488	EQUOS 2L/35 MD-EL RU	107	65287	KIT 1/102 AT	406	67006	KIT 2/60 EL GR	407
63888	STAR L60/2X55 EL RU	125	64491	EQUOS 2/70 MD-EL BI	107	65288	KIT 1/102 RU	406	67007	KIT 2/60 EL AT	407
63971	KIT 1 EL BI	138	64496	EQUOS 2/70 MD-EL GR	107	65296	KIT 2/60 GR	407	67008	KIT 2/60 EL RU	407
63976	KIT 1 EL GR	138	64497	EQUOS 2/70 MD-EL AT	107	65297	KIT 2/60 AT	407	67026	KIT 2/100 EL GR	407
63977	KIT 1 EL AT	138	64498	EQUOS 2/70 MD-EL RU	107	65298	KIT 2/60 RU	407	67027	KIT 2/100 EL AT	407
63978	KIT 1 EL RU	138	64501	EQUOS 2/150 MD-EL BI	107	65306	KIT 2/100 GR	407	67028	KIT 2/100 EL RU	407
63991	KIT 2 EL BI	138	64506	EQUOS 2/150 MD-EL GR	107	65307	KIT 2/100 AT	407	67046	KIT 2/62 EL GR	407
63996	KIT 2 EL GR	138	64507	EQUOS 2/150 MD-EL AT	107	65308	KIT 2/100 RU	407	67047	KIT 2/62 EL AT	407
63997	KIT 2 EL AT	138	64508	EQUOS 2/150 MD-EL RU	107	65316	KIT 2/62 GR	407	67048	KIT 2/62 EL RU	407
63998	KIT 2 EL RU	138	64511	EQUOS MIX 70 MD-EL BI	107	65317	KIT 2/62 AT	407	67066	KIT 2/102 EL GR	407
64031	STAR C120/2X54 EL BI	123	64516	EQUOS MIX 70 MD-EL GR	107	65318	KIT 2/62 RU	407	67067	KIT 2/102 EL AT	407
64036	STAR C120/2X54 EL GR	123	64517	EQUOS MIX 70 MD-EL AT	107	6532					

cod.	artículo/item	pag.	cod.	artículo/item	pag.	cod.	artículo/item	pag.	cod.	artículo/item	pag.
67076	BOX 60A/2X36 EL GR	435	68498	PLAZA 92/2x26 EL RU	430	70741	TUTTOTONDO 600 DM RGB DIG BI	267	71980	YOYO 600 CR	270
67077	BOX 60A/2X36 EL AT	435	68506	PLAZA182/2x26 EL GR	430	70746	TUTTOTONDO 600 DM RGB DIG AL	267	71981	YOYO 600 BI	270
67078	BOX 60A/2X36 EL RU	435	68507	PLAZA 182/2x26 EL AT	430	70747	TUTTOTONDO 600 DM RGB DIG NE	267	71990	YOYO 900 CR	270
67086	BOX 60B/2X36 EL GR	435	68508	PLAZA 182/2x26 EL RU	430	70751	TUTTOTONDO 600 DM RGB DALI BI	267	71991	YOYO 900 BI	270
67087	BOX 60B/2X36 EL AT	435	68516	BOX 30A/26 EL GR	434	70756	TUTTOTONDO 600 DM RGB DALI AL	267	72071	NORDICA	329
67088	BOX 60B/2X36 EL RU	435	68517	BOX 30A/26 EL AT	434	70757	TUTTOTONDO 600 DM RGB DALI NE	267	72110	TRILYUM	341
67096	BOX 60C/2X36 EL GR	435	68518	BOX 30A/26 EL RU	434	70761	TUTTOTONDO 900 DM RGB DIG BI	267	72231	OPEN 250	326
67097	BOX 60C/2X36 EL AT	435	68526	BOX 30B/26 EL GR	434	70766	TUTTOTONDO 900 DM RGB DIG AL	267	72241	OPEN 350	326
67098	BOX 60C/2X36 EL RU	435	68527	BOX 30B/26 EL AT	434	70767	TUTTOTONDO 900 DM RGB DIG NE	267	72251	OPEN 450	326
67106	BEST 50/35 MD-EL GR	419	68528	BOX 30B/26 EL RU	434	70771	TUTTOTONDO 900 DM RGB DALI BI	267	72280	STILO 400 CR	316
67107	BEST 50/35 MD-EL AT	419	68536	BOX 30C/26 EL GR	434	70776	TUTTOTONDO 900 DM RGB DALI AL	267	72281	STILO 400 BI	316
67108	BEST 50/35 MD-EL RU	419	68537	BOX 30C/26 EL AT	434	70777	TUTTOTONDO 900 DM RGB DALI NE	267	72310	STILO 500 CR	317
67116	BEST 50/70 MD-EL GR	419	68538	BOX 30C/26 EL RU	434	70780	YOYO 600 LED-W RGB DIG CR	273	72311	STILO 500 BI	317
67117	BEST 50/70 MD-EL AT	419	68876	LAND 90 EL GR	421	70781	YOYO 600 LED-W RGB DIG BI	273	72340	STILO 600 CR	318
67118	BEST 50/70 MD-EL RU	419	68877	LAND 90 EL AT	421	70790	YOYO 600 LED-W RGB DALI CR	273	72341	STILO 600 BI	318
67126	BEST 90/35 MD-EL GR	419	68878	LAND 90 EL RU	421	70791	YOYO 600 LED-W RGB DALI BI	273	74251	TUTTOTONDO 600 LED-W BI	264
67127	BEST 90/35 MD-EL AT	419	68896	VISOR 90 EL GR	423	70800	YOYO 600 LED-N RGB DIG CR	273	74256	TUTTOTONDO 600 LED-W AL	264
67128	BEST 90/35 MD-EL RU	419	68897	VISOR 90 EL AT	423	70801	YOYO 600 LED-N RGB DIG BI	273	74257	TUTTOTONDO 600 LED-W NE	264
67136	BEST 90/70 MD-EL GR	419	68898	VISOR 90 EL RU	423	70810	YOYO 600 LED-N RGB DALI CR	273	74261	TUTTOTONDO 600 DM LED-W BI	264
67137	BEST 90/70 MD-EL AT	419	68916	BEST 90 EL GR	419	70811	YOYO 600 LED-N RGB DALI BI	273	74266	TUTTOTONDO 600 DM LED-W AL	264
67138	BEST 90/70 MD-EL RU	419	68917	BEST 90 EL AT	419	70820	YOYO 900 LED-W RGB DIG CR	273	74267	TUTTOTONDO 600 DM LED-W NE	264
67146	LAND 50/70 MD-EL GR	421	68918	BEST 90 EL RU	419	70821	YOYO 900 LED-W RGB DIG BI	273	74271	TUTTOTONDO 600 EM LED-W BI	264
67147	LAND 50/70 MD-EL AT	421	68990	BASE TIRAFONDI	419	70830	YOYO 900 LED-W RGB DALI CR	273	74276	TUTTOTONDO 600 EM LED-W AL	264
67148	LAND 50/70 MD-EL RU	421	69991	FRANGILUCE 30	434	70831	YOYO 900 LED-W RGB DALI BI	273	74277	TUTTOTONDO 600 EM LED-W NE	264
67156	LAND 90/70 MD-EL GR	421	69992	FRANGILUCE 60	435	70840	YOYO 900 LED-N RGB DIG CR	273	74281	TUTTOTONDO 600 LED-N BI	264
67157	LAND 90/70 MD-EL AT	421	69993	FRANGILUCE 120	436	70841	YOYO 900 LED-N RGB DIG BI	273	74286	TUTTOTONDO 600 LED-N AL	264
67158	LAND 90/70 MD-EL RU	421	69994	FRANGILUCE 150	437	70850	YOYO 900 LED-N RGB DALI CR	273	74287	TUTTOTONDO 600 LED-N NE	264
67166	VISOR 50/70 MD-EL GR	423	70040	DUO 120/2X54 EM CR	287	70851	YOYO 900 LED-N RGB DALI BI	273	74291	TUTTOTONDO 600 DM LED-N BI	264
67167	VISOR 50/70 MD-EL AT	423	70046	DUO 120/2X54 EM AL	287	70860	STILO 400/C EM CR	316	74296	TUTTOTONDO 600 DM LED-N AL	264
67168	VISOR 50/70 MD-EL RU	423	70048	DUODK 120/2X54 EM CR	289	70861	STILO 400/C EM BI	316	74297	TUTTOTONDO 600 DM LED-N NE	264
67176	VISOR 90/70 MD-EL GR	423	70049	DUODK 120/2X54 EM AL	289	70870	STILO 500/C EM CR	317	74301	TUTTOTONDO 600 EM LED-N BI	264
67177	VISOR 90/70 MD-EL AT	423	70050	DUO 150/2X80 EM CR	288	70871	STILO 500/C EM BI	317	74306	TUTTOTONDO 600 EM LED-N AL	264
67178	VISOR 90/70 MD-EL RU	423	70056	DUO 150/2X80 EM AL	288	70880	STILO 600/C EM CR	318	74307	TUTTOTONDO 600 EM LED-N NE	264
68006	LAND 50 EL GR	421	70058	DUODK 150/2X80 EM CR	289	70881	STILO 600/C EM BI	318	74311	TUTTOTONDO 900 LED-W BI	264
68007	LAND 50 EL AT	421	70059	DUODK 150/2X80 EM AL	289	70941	KIT GRAPPOLO 2	313	74316	TUTTOTONDO 900 LED-W AL	264
68008	LAND 50 EL RU	421	70060	DUO 120/4X54 EM CR	287	70951	KIT GRAPPOLO 3	313	74317	TUTTOTONDO 900 LED-W NE	264
68026	VISOR 50 EL GR	423	70066	DUO 120/4X54 EM AL	287	70961	KIT GRAPPOLO 4	313	74321	TUTTOTONDO 900 DM LED-W BI	264
68027	VISOR 50 EL AT	423	70068	DUODK 120/4X54 EM CR	289	70992	FILTRO GIALLO	325	74326	TUTTOTONDO 900 DM LED-W AL	264
68028	VISOR 50 EL RU	423	70069	DUODK 120/4X54 EM AL	289	70993	FILTRO ROSSO	325	74327	TUTTOTONDO 900 DM LED-W NE	264
68046	BEST 50 EL GR	419	70070	DUO 150/4X80 EM CR	288	70995	FILTRO BLU	325	74331	TUTTOTONDO 900 EM LED-W BI	264
68047	BEST 50 EL AT	419	70076	DUO 150/4X80 EM AL	288	70998	FILTRO ARANCIONE	325	74336	TUTTOTONDO 900 EM LED-W AL	264
68048	BEST 50 EL RU	419	70078	DUODK 150/4X80 EM CR	289	71020	STILO 400/C CR	316	74337	TUTTOTONDO 900 EM LED-W NE	264
68066	GRILL 85 EL GR	413	70079	DUODK 150/4X80 EM AL	289	71022	STILO 400/C BI	316	74341	TUTTOTONDO 900 LED-N BI	264
68067	GRILL 85 EL AT	413	70131	AREA 400 EM BI	304	71023	TUTTOTONDO 600 BI	264	74346	TUTTOTONDO 900 LED-N AL	264
68068	GRILL 85 EL RU	413	70141	AREA 500 EM BI	305	71026	TUTTOTONDO 600 AL	264	74347	TUTTOTONDO 900 LED-N NE	264
68086	FARO 85 EL GR	416	70210	YOYO 600 EM CR	270	71027	TUTTOTONDO 600 NE	264	74351	TUTTOTONDO 900 DM LED-N BI	264
68087	FARO 85 EL AT	416	70211	YOYO 600 EM BI	270	71030	STILO 500/C CR	317	74356	TUTTOTONDO 900 DM LED-N AL	264
68088	FARO 85 EL RU	416	70220	YOYO 900 EM CR	270	71032	STILO 500/C BI	317	74357	TUTTOTONDO 900 DM LED-N NE	264
68106	ISY 85 EL GR	411	70221	YOYO 900 EM BI	270	71033	TUTTOTONDO 900 BI	264	74361	TUTTOTONDO 900 EM LED-N BI	264
68107	ISY 85 EL AT	411	70236	JOB 400 EM AL	301	71036	TUTTOTONDO 900 AL	264	74366	TUTTOTONDO 900 EM LED-N AL	264
68108	ISY 85 EL RU	411	70246	JOB 500 EM AL	301	71037	TUTTOTONDO 900 NE	264	74367	TUTTOTONDO 900 EM LED-N NE	264
68346	FARO 50 EL GR	416	70261	TUTTOTONDO 600 EM BI	264	71040	STILO 600/C CR	318	74370	YOYO 600 LED-W CR	270
68347	FARO 50 EL AT	416	70266	TUTTOTONDO 600 EM AL	264	71041	STILO 600/C BI	318	74371	YOYO 600 LED-W BI	270
68348	FARO 50 EL RU	416	70267	TUTTOTONDO 600 EM NE	264	71420	ARTIKA 400 AL	333	74380	YOYO 600 DM LED-W CR	270
68356	ISY 50 EL GR	411	70271	TUTTOTONDO 900 EM BI	264	71421	ARTIKA 400 BI	333	74381	YOYO 600 DM LED-W BI	270
68357	ISY 50 EL AT	411	70276	TUTTOTONDO 900 EM AL	264	71429	ARTIKA 400 NE	333	74390	YOYO 600 EM LED-W CR	270
68358	ISY 50 EL RU	411	70277	TUTTOTONDO 900 EM NE	264	71500	RAILROAD 400 AL	338	74391	YOYO 600 EM LED-W BI	270
68366	GRILL 50 EL GR	413	70281	FILO IP65 EM BI	295	71501	RAILROAD 400 BI	338	74400	YOYO 600 LED-N CR	270
68367	GRILL 50 EL AT	413	70286	FILO IP65 EM GR	295	71509	RAILROAD 400 NE	338	74401	YOYO 600 LED-N BI	270
68368	GRILL 50 EL RU	413	70287	FILO IP65 EM AT	295	71510	WORK 370 AL	335	74410	YOYO 600 DM LED-N CR	270
68376	FARO 70 EL GR	416	70288	FILO IP65 EM RU	295	71511	WORK 370 BI	335	74411	YOYO 600 DM LED-N BI	270
68377	FARO 70 EL AT	416	70290	DUO 90/2X39 EM CR	286	71519	WORK 370 NE	335	74420	YOYO 600 EM LED-N CR	270
68378	FARO 70 EL RU	416	70296	DUO 90/2X39 EM AL	286	71530	ZEUS GR	343	74421	YOYO 600 EM LED-N BI	270
68386	ISY 70 EL GR	411	70298	DUODK 90/2X39 EM CR	289	71537	ZEUS AT	343	74430	YOYO 900 LED-W CR	270
68387	ISY 70 EL AT	411	70299	DUODK 90/2X39 EM AL	289	71538	ZEUS RA	343	74431	YOYO 900 LED-W BI	270
68388	ISY 70 EL RU	411	70300	DUO 90/4X39 EM CR	286	71539	ZEUS BR	343	74440	YOYO 900 DM LED-W CR	270
68396	GRILL 70 EL GR	413	70306	DUO 90/4X39 EM AL	286	71571	AREA 300 BI	304	74441	YOYO 900 DM LED-W BI	270
68397	GRILL 70 EL AT	413	70308	DUODK 90/4X39 EM CR	289	71581	AREA 400 BI	304	74450	YOYO 900 EM LED-W CR	270
68398	GRILL 70 EL RU	413	70309	DUODK 90/4X39 EM AL	289	71596	JOB 300 AL	301	74451	YOYO 900 EM LED-W BI	270
68436	PARK 90/26 EL GR	426	70490	STILO 400 EM CR	316	71606	JOB 400 AL	301	74460	YOYO 900 LED-N CR	270
68437	PARK 90/26 EL AT	426	70491	STILO 400 EM BI	316	71610	COSMO 300 TR	312	74461	YOYO 900 LED-N BI	270
68438	PARK 90/26 EL RU	426	70520	STILO 500 EM CR	317	71612	COSMO 300 GI	312	74470	YOYO 900 DM LED-N CR	270
68446	PARK 180/26 EL GR	426	70521	STILO 500 EM BI	317	71613	COSMO 300 RO	312	74471	YOYO 900 DM LED-N BI	270
68447	PARK 180/26 EL AT	426	70550	STILO 600 EM CR	318	71615	COSMO 300 BL	312	74480	YOYO 900 EM LED-N CR	270
68448	PARK 180/26 EL RU	426	70551	STILO 600 EM BI	318	71620	COSMO 400 TR	312	74481	YOYO 900 EM LED-N BI	270
68456	PARK 92/2x26 EL GR	426	70560	YOYO 600 DM RGB DIG CR	273	71622	COSMO 400 GI	312	74490	MONO 90 LED-W CR	280
68457	PARK 92/2x26 EL AT	426	70561	YOYO 600 DM RGB DIG BI	273	71623	COSMO 400 RO	312	74496	MONO 90 LED-W AL	280
68458	PARK 92/2x26 EL RU	426	70570	YOYO 600 DM RGB DALI CR	273	71625	COSMO 400 BL	312	74500	MONO 90S LED-W CR	280
68466	PARK 182/2x26 EL GR	426	70571	YOYO 600 DM RGB DALI BI	273	71630	COSMO 500 TR	312	74506	MONO 90S LED-W AL	280
68467	PARK 182/2x26 EL AT	426	70580	YOYO 900 DM RGB DIG CR	273	71632	COSMO 500 GI	312	74510	MONO 90S DM LED-W CR	280
68468	PARK 182/2x26 EL RU	426	70581	YOYO 900 DM RGB DIG BI	273	71633	COSMO 500 RO	312	74516	MONO 90S DM LED-W AL	280
68476	PLAZA 90/26 EL GR	430	70590	YOYO 900 DM RGB DALI CR	273	71635	COSMO 500 BL	312	74520	MONO 90 EM LED-W CR	280
68477	PLAZA 90/26 EL AT	430	70591	YOYO 900 DM RGB DALI BI	273	71640	COSMO 600 TR	313	74526	MONO 90 EM LED-W AL	280
68478	PLAZA 90/26 EL RU	430	70661	TUTTOTONDO 1200 EM BI	265	71642	COSMO 600 GI	313	74530	MONO 90S EM LED-W CR	280
68486	PLAZA 180/26 EL GR	430	70666	TUTTOTONDO 1200 EM AL	265	71643	COSMO 600 RO	313	74536	MONO 90S EM LED-W AL	280
68487	PLAZA 180/26 EL AT	430	70667	TUTTOTONDO 1200 EM NE	265	71645	COSMO 600 BL	313	74540	MONO 90 LED-N CR	280
68488	PLAZA 180/26 EL RU	430	70691	TUTTOTONDO 1800 EM BI	265	71651	MOON BI	307	74546	MONO 90 LED-N AL	280
68496	PLAZA 92/2x26 EL GR	430	70696	TUTTOTONDO 1800 EM AL	265	71657	MOON NE	307	74550	MONO 90S LED-N CR	280
68497	PLAZA 92/2x26 EL AT	430	70697	TUTTOTONDO 1800 EM NE	265	71841	GIROTONDO	331	74556	MONO 90S LED-N AL	280

14 applique interni/esterni
wall lights indoor/outdoor

150 plafoniere interni/esterni
ceiling bowls indoor/outdoor

248 testaleto
bed head units

258 sospensioni
suspensions

344 lampade
lamps

384 lampioni ed incassi
bollards & recessed lights</

cod.	articolo/item	pag.	cod.	articolo/item	pag.	cod.	articolo/item	pag.	cod.	articolo/item	pag.
74560	MONO 90S DM LED-N CR	280	75076	DUO 150S LED-W AL	288	75391	TAB S2 DM LED-W AN	276	75831	STILO 400/C DM LED-W BI	316
74566	MONO 90S DM LED-N AL	280	75080	DUO 150S DM LED-W CR	288	75396	TAB S2 DM LED-W AL	276	75840	STILO 400/C LED-N CR	316
74570	MONO 90 EM LED-N CR	280	75086	DUO 150S DM LED-W AL	288	75401	TAB S2 LED-N AN	276	75841	STILO 400/C LED-N BI	316
74576	MONO 90 EM LED-N AL	280	75090	DUO 150 EM LED-W CR	288	75406	TAB S2 LED-N AL	276	75850	STILO 400/C DM LED-N CR	316
74580	MONO 90S EM LED-N CR	280	75096	DUO 150 EM LED-W AL	288	75411	TAB S2 DM LED-N AN	276	75851	STILO 400/C DM LED-N BI	316
74586	MONO 90S EM LED-N AL	280	75100	DUO 150S EM LED-W CR	288	75416	TAB S2 DM LED-N AL	276	75860	STILO 500/C LED-W CR	317
74590	MONO 120 LED-W CR	281	75106	DUO 150S EM LED-W AL	288	75421	TAB S4 LED-W AN	277	75861	STILO 500/C LED-W BI	317
74596	MONO 120 LED-W AL	281	75110	DUO 150 LED-N CR	288	75426	TAB S4 LED-W AL	277	75870	STILO 500/C DM LED-W CR	317
74600	MONO 120S LED-W CR	281	75116	DUO 150 LED-N AL	288	75431	TAB S4 DM LED-W AN	277	75871	STILO 500/C DM LED-W BI	317
74606	MONO 120S LED-W AL	281	75120	DUO 150S LED-N CR	288	75436	TAB S4 DM LED-W AL	277	75880	STILO 500/C LED-N CR	317
74610	MONO 120S DM LED-W CR	281	75126	DUO 150S LED-N AL	288	75441	TAB S4 LED-N AN	277	75881	STILO 500/C LED-N BI	317
74616	MONO 120S DM LED-W AL	281	75130	DUO 150S DM LED-N CR	288	75446	TAB S4 LED-N AL	277	75890	STILO 500/C DM LED-N CR	317
74620	MONO 120 EM LED-W CR	281	75136	DUO 150S DM LED-N AL	288	75451	TAB S4 DM LED-N AN	277	75891	STILO 500/C DM LED-N BI	317
74626	MONO 120 EM LED-W AL	281	75140	DUO 150 EM LED-N CR	288	75456	TAB S4 DM LED-N AL	277	75900	STILO 600/C LED-W CR	318
74630	MONO 120S EM LED-W CR	281	75146	DUO 150 EM LED-N AL	288	75461	TAB SQ LED-W AN	277	75901	STILO 600/C LED-W BI	318
74636	MONO 120S EM LED-W AL	281	75150	DUO 150S EM LED-N CR	288	75466	TAB SQ LED-W AL	277	75910	STILO 600/C DM LED-W CR	318
74640	MONO 120 LED-N CR	281	75156	DUO 150S EM LED-N AL	288	75471	TAB SQ DM LED-W AN	277	75911	STILO 600/C DM LED-W BI	318
74646	MONO 120 LED-N AL	281	75161	FILO IP65 LED-W BI	295	75476	TAB SQ DM LED-W AL	277	75920	STILO 600/C LED-N CR	318
74650	MONO 120S LED-N CR	281	75166	FILO IP65 LED-W GR	295	75481	TAB SQ LED-N AN	277	75921	STILO 600/C LED-N BI	318
74656	MONO 120S LED-N AL	281	75167	FILO IP65 LED-W AT	295	75486	TAB SQ LED-N AL	277	75930	STILO 600/C DM LED-N CR	318
74660	MONO 120S DM LED-N CR	281	75168	FILO IP65 LED-W RU	295	75491	TAB SQ DM LED-N AN	277	75931	STILO 600/C DM LED-N BI	318
74666	MONO 120S DM LED-N AL	281	75171	FILO IP65 DM LED-W BI	295	75496	TAB SQ DM LED-N AL	277	75940	WORK 370 LED-W AL	335
74670	MONO 120 EM LED-N CR	281	75176	FILO IP65 DM LED-W GR	295	75501	FLASH S4S-W BI	297	75941	WORK 370 LED-W BI	335
74676	MONO 120 EM LED-N AL	281	75177	FILO IP65 DM LED-W AT	295	75509	FLASH S4S-W AL	297	75949	WORK 370 LED-W NE	335
74680	MONO 120S EM LED-N CR	281	75178	FILO IP65 DM LED-W RU	295	75511	FLASH S4S-W DM BI	297	75950	WORK 370 DM LED-W AL	335
74686	MONO 120S EM LED-N AL	281	75181	FILO IP65 LED-N BI	295	75519	FLASH S4S-W DM AL	297	75951	WORK 370 DM LED-W BI	335
74690	MONO 150 LED-W CR	282	75186	FILO IP65 LED-N GR	295	75521	FLASH S4S-N BI	297	75959	WORK 370 DM LED-W NE	335
74696	MONO 150 LED-W AL	282	75187	FILO IP65 LED-N AT	295	75529	FLASH S4S-N AL	297	75960	WORK 370 LED-N AL	335
74700	MONO 150S LED-W CR	282	75188	FILO IP65 LED-N RU	295	75531	FLASH S4S-N DM BI	297	75961	WORK 370 LED-N BI	335
74706	MONO 150S LED-W AL	282	75191	FILO IP65 DM LED-N BI	295	75539	FLASH S4S-N DM AL	297	75969	WORK 370 LED-N NE	335
74710	MONO 150S DM LED-W CR	282	75196	FILO IP65 DM LED-N GR	295	75541	FLASH S4L-W BI	297	75970	WORK 370 DM LED-N AL	335
74716	MONO 150S DM LED-W AL	282	75197	FILO IP65 DM LED-N AT	295	75549	FLASH S4L-W AL	297	75971	WORK 370 DM LED-N BI	335
74720	MONO 150 EM LED-W CR	282	75198	FILO IP65 DM LED-N RU	295	75551	FLASH S4L-W DM BI	297	75979	WORK 370 DM LED-N NE	335
74726	MONO 150 EM LED-W AL	282	75201	AREA 400 LED-W BI	304	75559	FLASH S4L-W DM AL	297	75980	ZEUS LED-W GR	343
74730	MONO 150S EM LED-W CR	282	75211	AREA 400 LED-N BI	304	75561	FLASH S4L-N BI	297	75987	ZEUS LED-W AT	343
74736	MONO 150S EM LED-W AL	282	75221	AREA 500 LED-W NE	305	75569	FLASH S4L-N AL	297	75988	ZEUS LED-W RM	343
74740	MONO 150 LED-N CR	282	75231	AREA 500 LED-N AL	305	75571	FLASH S4L-N DM BI	297	75989	ZEUS LED-W BR	343
74746	MONO 150 LED-N AL	282	75241	MOON LED-W BI	307	75579	FLASH S4L-N DM AL	297	75990	ZEUS LED-N GR	343
74750	MONO 150S LED-N CR	282	75247	MOON LED-W NE	307	75581	FLASH SQS-W BI	297	75997	ZEUS LED-N AT	343
74756	MONO 150S LED-N AL	282	75251	MOON DM LED-W BI	307	75589	FLASH SQS-W AL	297	75998	ZEUS LED-N RM	343
74760	MONO 150S DM LED-N CR	282	75257	MOON DM LED-W NE	307	75591	FLASH SQS-W DM BI	297	75999	ZEUS LED-N BR	343
74766	MONO 150S DM LED-N AL	282	75261	MOON LED-N BI	307	75599	FLASH SQS-W DM AL	297	76000	RAILROAD 400 LED-W AL	338
74770	MONO 150 EM LED-N CR	282	75267	MOON LED-N NE	307	75601	FLASH SQS-N BI	297	76001	RAILROAD 400 LED-W BI	338
74776	MONO 150 EM LED-N AL	282	75271	MOON DM LED-N BI	307	75609	FLASH SQS-N AL	297	76009	RAILROAD 400 LED-W NE	338
74780	MONO 150S EM LED-N CR	282	75277	MOON DM LED-N NE	307	75611	FLASH SQS-N DM BI	297	76010	RAILROAD 400 DM LED-W AL	338
74786	MONO 150S EM LED-N AL	282	75280	SOLARIUM LED-W CR	309	75619	FLASH SQS-N DM AL	297	76011	RAILROAD 400 DM LED-W BI	338
74790	DUO 90 LED-W CR	286	75281	SOLARIUM LED-W BI	309	75621	FLASH SQL-W BI	297	76019	RAILROAD 400 DM LED-W NE	338
74796	DUO 90 LED-W AL	286	75287	SOLARIUM LED-W NE	309	75629	FLASH SQL-W AL	297	76020	RAILROAD 400 LED-N AL	338
74800	DUO 90S LED-W CR	286	75290	SOLARIUM DIG LED-W CR	309	75631	FLASH SQL-W DM BI	297	76021	RAILROAD 400 LED-N BI	338
74806	DUO 90S LED-W AL	286	75291	SOLARIUM DIG LED-W BI	309	75639	FLASH SQL-W DM AL	297	76029	RAILROAD 400 LED-N NE	338
74810	DUO 90S DM LED-W CR	286	75297	SOLARIUM DIG LED-W NE	309	75641	FLASH SQL-N BI	297	76030	RAILROAD 400 DM LED-N AL	338
74816	DUO 90S DM LED-W AL	286	75300	SOLARIUM DALI LED-W CR	309	75649	FLASH SQL-N AL	297	76031	RAILROAD 400 DM LED-N BI	338
74820	DUO 90 EM LED-W CR	286	75301	SOLARIUM DALI LED-W BI	309	75651	FLASH SQL-N DM BI	297	76039	RAILROAD 400 DM LED-N NE	338
74826	DUO 90 EM LED-W AL	286	75307	SOLARIUM DALI LED-W NE	309	75659	FLASH SQL-N DM AL	297	76041	ASIA 250 LED-W BI	322
74830	DUO 90S EM LED-W CR	286	75310	SOLARIUM LED-N CR	309	75661	VOG S4-W BI	299	76047	ASIA 250 LED-W NE	322
74836	DUO 90S EM LED-W AL	286	75311	SOLARIUM LED-N BI	309	75669	VOG S4-W AL	299	76051	ASIA 250 LED-N BI	322
74840	DUO 90 LED-N CR	286	75317	SOLARIUM LED-N NE	309	75671	VOG S4-N BI	299	76057	ASIA 250 LED-N NE	322
74846	DUO 90 LED-N AL	286	75320	SOLARIUM DIG LED-N CR	309	75679	VOG S4-N AL	299	76061	ASIA 350 LED-W BI	322
74850	DUO 90S LED-N CR	286	75321	SOLARIUM DIG LED-N BI	309	75681	VOG SQ-W BI	299	76067	ASIA 350 LED-W NE	322
74856	DUO 90S LED-N AL	286	75327	SOLARIUM DIG LED-N NE	309	75689	VOG SQ-W AL	299	76071	ASIA 350 LED-N BI	322
74860	DUO 90S DM LED-N CR	286	75330	SOLARIUM DALI LED-N CR	309	75691	VOG SQ-N BI	299	76077	ASIA 350 LED-N NE	322
74866	DUO 90S DM LED-N AL	286	75331	SOLARIUM DALI LED-N BI	309	75699	VOG SQ-N AL	299	76081	ASIA 550 LED-W BI	322
74870	DUO 90 EM LED-N CR	286	75337	SOLARIUM DALI LED-N NE	309	75700	STILO 400 LED-W CR	316	76087	ASIA 550 LED-W NE	322
74876	DUO 90 EM LED-N AL	286	75340	COSMO 300 LED-W TR	312	75701	STILO 400 LED-W BI	316	76091	ASIA 550 DM LED-W BI	322
74880	DUO 90S EM LED-N CR	286	75341	TAB S1 LED-W AN	276	75710	STILO 400 DM LED-W CR	316	76097	ASIA 550 DM LED-W NE	322
74886	DUO 90S EM LED-N AL	286	75342	COSMO 300 LED-W GI	312	75711	STILO 400 DM LED-W BI	316	76101	ASIA 550 LED-N BI	322
74890	DUO 120 LED-W CR	287	75343	COSMO 300 LED-W RO	312	75720	STILO 400 LED-N CR	316	76107	ASIA 550 LED-N NE	322
74896	DUO 120 LED-W AL	287	75345	COSMO 300 LED-W BL	312	75721	STILO 400 LED-N BI	316	76111	ASIA 550 DM LED-N BI	322
74900	DUO 120S LED-W CR	287	75346	TAB S1 LED-W AL	276	75730	STILO 400 DM LED-N CR	316	76117	ASIA 550 DM LED-N NE	322
74906	DUO 120S LED-W AL	287	75350	COSMO 300 LED-N TR	312	75731	STILO 400 DM LED-N BI	316	77061	TUTTOTONDO 1200 EL BI	265
74910	DUO 120S DM LED-W CR	287	75351	TAB S1 DM LED-W AN	276	75740	STILO 500 LED-W CR	317	77066	TUTTOTONDO 1200 EL AL	265
74916	DUO 120S DM LED-W AL	287	75352	COSMO 300 LED-N GI	312	75741	STILO 500 LED-W BI	317	77067	TUTTOTONDO 1200 EL NE	265
74920	DUO 120 EM LED-W CR	287	75353	COSMO 300 LED-N RO	312	75750	STILO 500 DM LED-W CR	317	77081	TUTTOTONDO 1200 DM BI	265
74926	DUO 120 EM LED-W AL	287	75355	COSMO 300 LED-N BL	312	75751	STILO 500 DM LED-W BI	317	77086	TUTTOTONDO 1200 DM AL	265
74930	DUO 120S EM LED-W CR	287	75356	TAB S1 DM LED-W AL	276	75760	STILO 500 LED-N CR	317	77087	TUTTOTONDO 1200 DM NE	265
74936	DUO 120S EM LED-W AL	287	75360	COSMO 400 LED-W TR	312	75761	STILO 500 LED-N BI	317	77091	TUTTOTONDO 1800 EL BI	265
74940	DUO 120 LED-N CR	287	75361	TAB S1 LED-N AN	276	75770	STILO 500 DM LED-N CR	317	77096	TUTTOTONDO 1800 EL AL	265
74946	DUO 120 LED-N AL	287	75362	COSMO 400 LED-W GI	312	75771	STILO 500 DM LED-N BI	317	77097	TUTTOTONDO 1800 EL NE	265
74950	DUO 120S LED-N CR	287	75363	COSMO 400 LED-W RO	312	75780	STILO 600 LED-W CR	318	77111	TUTTOTONDO 1800 DM BI	265
74956	DUO 120S LED-N AL	287	75365	COSMO 400 LED-W BL	312	75781	STILO 600 LED-W BI	318	77116	TUTTOTONDO 1800 DM AL	265
74960	DUO 120S DM LED-N CR	287	75366	TAB S1 LED-N AL	276	75790	STILO 600 DM LED-W CR	318	77117	TUTTOTONDO 1800 DM NE	265
74966	DUO 120S DM LED-N AL	287	75370	COSMO 400 LED-N TR	312	75791	STILO 600 DM LED-W BI	318	77161	TUTTOTONDO 600 EL BI	264
74970	DUO 120 EM LED-N CR	287	75371	TAB S1 DM LED-N AN	276	75800	STILO 600 LED-N CR	318	77166	TUTTOTONDO 600 EL AL	264
74976	DUO 120 EM LED-N AL	287	75372	COSMO 400 LED-N GI	312	75801	STILO 600 LED-N BI	318	77167	TUTTOTONDO 600 EL NE	264
74980	DUO 120S EM LED-N CR	287	75373	COSMO 400 LED-N RO	312	75810	STILO 600 DM LED-N CR	318	77171	TUTTOTONDO 600 DM BI	264
74986	DUO 120S EM LED-N AL	287	75375	COSMO 400 LED-N BL	312	75811	STILO 600 DM LED-N BI	318	77176	TUTTOTONDO 600 DM AL	264
75060	DUO 150 LED-W CR	288	75376	TAB S1 DM LED-N AL	276	75820	STILO 400/C LED-W CR	316	77177	TUTTOTONDO 600 DM NE	264
75066	DUO 150 LED-W AL	288	75381	TAB S2 LED-W AN	276	75821	STILO 400/C LED-W BI	316	77181	TUTTOTONDO 900 EL BI	264
75070	DUO 150S LED-W CR	288	75386	TAB S2 LED-W AL	276	75830	STILO 400/C DM LED-W CR				

cod.	articolo/item	pag.	cod.	articolo/item	pag.	cod.	articolo/item	pag.	cod.	articolo/item	pag.
77187	TUTTOTONDO 900 EL NE	264	79021	YOYO 600 EL BI	270	81446	DUO/T GR	381	91051	INKA 2 BI	396
77191	TUTTOTONDO 900 DM BI	264	79040	YOYO 900 EL CR	270	81466	DUO/T EM GR	381	91056	INKA 2 GR	396
77196	TUTTOTONDO 900 DM AL	264	79041	YOYO 900 EL BI	270	81540	RETRO/T CR	377	91057	INKA 2 AT	396
77197	TUTTOTONDO 900 DM NE	264	79130	YOYO 600 DM CR	270	81542	RETRO/T OR	377	91058	INKA 2 RU	396
77201	FILO IP65 EL BI	295	79131	YOYO 600 DM BI	270	81590	COSMO/T LED-W TR	351	91061	INKA 3 BI	397
77206	FILO IP65 EL GR	295	79150	YOYO 900 DM CR	270	81592	COSMO/T LED-W GI	351	91066	INKA 3 GR	397
77207	FILO IP65 EL AT	295	79151	YOYO 900 DM BI	270	81593	COSMO/T LED-W RO	351	91067	INKA 3 AT	397
77208	FILO IP65 EL RU	295	79220	DUO 90/4X39 DM CR	286	81595	COSMO/T LED-W BL	351	91068	INKA 3 RU	397
78031	AREA 300 EL BI	304	79226	DUO 90/4X39 DM AL	286	81600	COSMO/T LED-N TR	351	91071	KUBA BI	391
78041	AREA 400 EL BI	304	79228	DUODK 90/4X39 DM CR	289	81602	COSMO/T LED-N GI	351	91076	KUBA GR	391
78061	AREA 400 DM BI	304	79229	DUODK 90/4X39 DM AL	289	81603	COSMO/T LED-N RO	351	91077	KUBA AT	391
78071	AREA 500 EL BI	305	79240	DUO 120/4X54 DM CR	287	81605	COSMO/T LED-N BL	351	91078	KUBA RU	391
78091	AREA 500 DM BI	305	79246	DUO 120/4X54 DM AL	287	81611	VITRUM LED-W	371	92151	KUBA EL BI	391
78101	OPEN 450 EL/84	326	79248	DUODK 120/4X54 DM CR	289	81621	VITRUM LED-N	371	92156	KUBA EL GR	391
78110	ARTIKA 400 EL AL	333	79249	DUODK 120/4X54 DM AL	289	81636	DUO/T LED-W GR	381	92157	KUBA EL AT	391
78111	ARTIKA 400 EL BI	333	79260	DUO 150/4X80 DM CR	288	81646	DUO/T LED-N GR	381	92158	KUBA EL RU	391
78119	ARTIKA 400 EL NE	333	79266	DUO 150/4X80 DM AL	288	81656	DUO/T EM LED-W GR	381	92161	KUBA EM BI	391
78151	OPEN 450 DM/84	326	79268	DUODK 150/4X80 DM CR	289	81666	DUO/T EM LED-N GR	381	92166	KUBA EM GR	391
78176	JOB 300 EL AL	301	79269	DUODK 150/4X80 DM AL	289	85121	ALICE/G	361	92167	KUBA EM AT	391
78186	JOB 400 EL AL	301	79280	MONO 90/2X39 DM CR	280	85130	COSMO/G300 TR	349	92168	KUBA EM RU	391
78206	JOB 400 DM AL	301	79286	MONO 90/2X39 DM AL	280	85132	COSMO/G300 GI	349	93201	KUBAMINI LED-N BI	391
78216	JOB 500 EL AL	301	79288	MONODK 90/2X39 DM CR	283	85133	COSMO/G300 RO	349	93206	KUBAMINI LED-N GR	391
78236	JOB 500 DM AL	301	79289	MONODK 90/2X39 DM AL	283	85135	COSMO/G300 BL	349	93207	KUBAMINI LED-N AT	391
78240	STILO 400/C EL CR	316	79300	MONO 120/2X54 DM CR	281	85151	GIROTONDO/G	365	93208	KUBAMINI LED-N RU	391
78241	STILO 400/C EL BI	316	79306	MONO 120/2X54 DM AL	281	85208	AVALON CR	359	93211	KUBAMINI LED-W BI	391
78250	STILO 400/C DM CR	316	79308	MONODK 120/2X54 DM CR	283	85211	CUT-OFF BI	357	93216	KUBAMINI LED-W GR	391
78251	STILO 400/C DM BI	316	79309	MONODK 120/2X54 DM AL	283	85217	CUT-OFF NE	357	93217	KUBAMINI LED-W AT	391
78260	STILO 500/C EL CR	317	79320	MONO 150/2X80 DM CR	282	85231	JULY/G	363	93218	KUBAMINI LED-W RU	391
78261	STILO 500/C EL BI	317	79326	MONO 150/2X80 DM AL	282	85280	TRILYUM/G	379	93221	KUBA LED-W BI	391
78270	STILO 500/C DM CR	317	79328	MONODK 150/2X80 DM CR	283	85330	COSMO/G400 TR	349	93226	KUBA LED-W GR	391
78271	STILO 500/C DM BI	317	79329	MONODK 150/2X80 DM AL	283	85332	COSMO/G400 GI	349	93227	KUBA LED-W AT	391
78280	STILO 600/C EL CR	318	79330	COSMO 300 EL TR	312	85333	COSMO/G400 RO	349	93228	KUBA LED-W RU	391
78281	STILO 600/C EL BI	318	79332	COSMO 300 EL GI	312	85335	COSMO/G400 BL	349	93231	KUBA LED-N BI	391
78290	STILO 600/C DM CR	318	79333	COSMO 300 EL RO	312	85340	CHROME/G CR	373	93236	KUBA LED-N GR	391
78291	STILO 600/C DM BI	318	79335	COSMO 300 EL BL	312	85347	CHROME/G NE	373	93237	KUBA LED-N AT	391
78530	MONO 90/39 EL CR	280	79340	COSMO 400 EL/42 TR	312	85350	RETRO/G CR	377	93238	KUBA LED-N RU	391
78536	MONO 90/39 EL AL	280	79342	COSMO 400 EL/42 GI	312	85352	RETRO/G OR	377	93241	INKA 1 LED-W BI	396
78538	MONODK 90/39 EL CR	283	79343	COSMO 400 EL/42 RO	312	85360	DADO PLISSE/G CR	375	93246	INKA 1 LED-W GR	396
78539	MONODK 90/39 EL AL	283	79345	COSMO 400 EL/42 BL	312	85362	DADO PLISSE/G AV	375	93247	INKA 1 LED-W AT	396
78540	MONO 120/54 EL CR	281	79350	COSMO 400 EL/84 TR	312	85368	DADO/G CR	375	93248	INKA 1 LED-W RU	396
78546	MONO 120/54 EL AL	281	79352	COSMO 400 EL/84 GI	312	85370	COSMO/G300 LED-W TR	349	93251	INKA 1 LED-N BI	396
78548	MONODK 120/54 EL CR	283	79353	COSMO 400 EL/84 RO	312	85372	COSMO/G300 LED-W GI	349	93256	INKA 1 LED-N GR	396
78549	MONODK 120/54 EL AL	283	79355	COSMO 400 EL/84 BL	312	85373	COSMO/G300 LED-W RO	349	93257	INKA 1 LED-N AT	396
78550	MONO 150/80 EL CR	282	79360	COSMO 500 EL/84 TR	312	85375	COSMO/G300 LED-W BL	349	93258	INKA 1 LED-N RU	396
78556	MONO 150/80 EL AL	282	79362	COSMO 500 EL/84 GI	312	85380	COSMO/G300 LED-N TR	349	93261	INKA 2 LED-W BI	396
78558	MONODK 150/80 EL CR	283	79363	COSMO 500 EL/84 RO	312	85382	COSMO/G300 LED-N GI	349	93266	INKA 2 LED-W GR	396
78559	MONODK 150/80 EL AL	283	79365	COSMO 500 EL/84 BL	312	85383	COSMO/G300 LED-N RO	349	93267	INKA 2 LED-W AT	396
78560	MONO 90/2X39 EL CR	280	79370	COSMO 600 EL/84 TR	313	85385	COSMO/G300 LED-N BL	349	93268	INKA 2 LED-W RU	396
78566	MONO 90/2X39 EL AL	280	79372	COSMO 600 EL/84 GI	313	85390	COSMO/G400 LED-W TR	349	93271	INKA 2 LED-N BI	396
78568	MONODK 90/2X39 EL CR	283	79373	COSMO 600 EL/84 RO	313	85392	COSMO/G400 LED-W GI	349	93276	INKA 2 LED-N GR	396
78569	MONODK 90/2X39 EL AL	283	79375	COSMO 600 EL/84 BL	313	85393	COSMO/G400 LED-W RO	349	93277	INKA 2 LED-N AT	396
78570	MONO 120/2X54 EL CR	281	79390	COSMO 400 DM/84 TR	312	85395	COSMO/G400 LED-W BL	349	93278	INKA 2 LED-N RU	396
78576	MONO 120/2X54 EL AL	281	79392	COSMO 400 DM/84 GI	312	85400	COSMO/G400 LED-N TR	349	93281	INKA 3 LED-W BI	397
78578	MONODK 120/2X54 EL CR	283	79393	COSMO 400 DM/84 RO	312	85402	COSMO/G400 LED-N GI	349	93286	INKA 3 LED-W GR	397
78579	MONODK 120/2X54 EL AL	283	79395	COSMO 400 DM/84 BL	312	85403	COSMO/G400 LED-N RO	349	93287	INKA 3 LED-W AT	397
78580	MONO 150/2X80 EL CR	282	79410	COSMO 500 DM/84 TR	312	85405	COSMO/G400 LED-N BL	349	93288	INKA 3 LED-W RU	397
78586	MONO 150/2X80 EL AL	282	79412	COSMO 500 DM/84 GI	312	85411	CUT-OFF LED-W BI	357	93291	INKA 3 LED-N BI	397
78588	MONODK 150/2X80 EL CR	283	79413	COSMO 500 DM/84 RO	312	85417	CUT-OFF LED-W NE	357	93296	INKA 3 LED-N GR	397
78589	MONODK 150/2X80 EL AL	283	79415	COSMO 500 DM/84 BL	312	85421	ASIA/G LED-W BI	355	93297	INKA 3 LED-N AT	397
78600	DUO 90/2X39 EL CR	286	79430	COSMO 600 DM/84 TR	313	85427	ASIA/G LED-W NE	355	93298	INKA 3 LED-N RU	397
78606	DUO 90/2X39 EL AL	286	79432	COSMO 600 DM/84 GI	313	85431	ASIA/G LED-N BI	355	93977	CASSAFORMA KUBAMINI	391
78608	DUODK 90/ 2X39 EL CR	289	79433	COSMO 600 DM/84 RO	313	85437	ASIA/G LED-N NE	355	93987	CASSAFORMA INKA	397
78609	DUODK 90/ 2X39 EL AL	289	79435	COSMO 600 DM/84 BL	313	80081	ALICE/P	361	93997	CASSAFORMA KUBA	391
78610	DUO 120/2X54 EL CR	287	79471	MOON EL BI	307	88090	COSMO/G200 BI	349	LC-F	CABLAGGIO F	292
78616	DUO 120/2X54 EL AL	287	79477	MOON EL NE	307	88151	JULY/P	363	LC-FX	CABLAGGIO FX	292
78618	DUODK 120/2X54 EL CR	289	79491	MOON DM BI	307	88160	TRILYUM/P	379	LC-G2	GIUNTO 2	292
78619	DUODK 120/2X54 EL AL	289	79497	MOON DM NE	307	88171	ASIA/P LED-W BI	355	LC-G3	GIUNTO 3	292
78620	DUO 150/2X80 EL CR	288	79680	STILO 400 EL CR	316	88177	ASIA/P LED-W NE	355	LC-G4	GIUNTO 4	292
78626	DUO 150/2X80 EL AL	288	79681	STILO 400 EL BI	316	88181	ASIA/P LED-N BI	355	LC-M	CABLAGGIO M	292
78628	DUODK 150/2X80 EL CR	289	79700	STILO 400 DM CR	316	88187	ASIA/P LED-N NE	355	LC-MF	CABLAGGIO MF	292
78629	DUODK 150/2X80 EL AL	289	79701	STILO 400 DM BI	316	88191	KYO BI	353	LC-MX	CABLAGGIO MX	292
78640	DUO 90/4X39 EL CR	286	79770	STILO 500 EL CR	317	88192	KYO GI	353	LC-R150	KIT ROSONE 150	292
78646	DUO 90/4X39 EL AL	286	79771	STILO 500 EL BI	317	88193	KYO AR	353	LC-R300	KIT ROSONE 300	292
78648	DUODK 90/4X39 EL CR	289	79790	STILO 500 DM CR	317	88196	KYO AL	353		BASIC	254
78649	DUODK 90/4X39 EL AL	289	79791	STILO 500 DM BI	317	88201	KYO LED-W BI	353		FLY	252
78650	DUO 120/4X54 EL CR	287	79860	STILO 600 EL CR	318	88202	KYO LED-W GI	353		NUBIS	256
78656	DUO 120/4X54 EL AL	287	79861	STILO 600 EL BI	318	88203	KYO LED-W AR	353		SMART	250
78658	DUODK 120/4X54 EL CR	289	79880	STILO 600 DM CR	318	88206	KYO LED-W AL	353			
78659	DUODK 120/4X54 EL AL	289	79881	STILO 600 DM BI	318	88211	KYO LED-N BI	353			
78660	DUO 150/4X80 EL CR	288	81180	COSMO/T TR	351	88212	KYO LED-N GI	353			
78666	DUO 150/4X80 EL AL	288	81182	COSMO/T GI	351	88213	KYO LED-N AR	353			
78668	DUODK 150/4X80 EL CR	289	81183	COSMO/T RO	351	88216	KYO LED-N AL	353			
78669	DUODK 150/4X80 EL AL	289	81185	COSMO/T BL	351	90060	ALIMENTATORE 60W-24V	9			
78810	WORK 370 EL AL	335	81201	GIROTONDO/T	365	90061	ALIMENTATORE 100W-24V	9			
78811	WORK 370 EL BI	335	81341	NORDICA/T2	367	90062	ALIMENTATORE 150W-24V	9			
78819	WORK 370 EL NE	335	81370	TI-LIGHT/T	368	91041	INKA 1 BI	396			
78991	OPEN 350 EL	326	81380	TRILYUM/T	379	91046	INKA 1 GR	396			
79001	OPEN 450 EL/42	326	81391	VITRUM BI	371	91047	INKA 1 AT	396			
79020	YOYO 600 EL CR	270	81436	TRIS 3X80	383	91048	INKA 1 RU	396			

Indice alfabetico

Alphabetic index Index alphabetique
Indice alfabético Index alphabetisch

A B C D E F G

articolo/item	pag.	articolo/item	pag.	articolo/item	pag.	articolo/item	pag.	articolo/item	pag.
A1 100	440	CABLAGGIO M	290	GAMMA 250	208	MOON	306	STEP 2	126
A1 200	440	CABLAGGIO MF	290	GAMMA 350	208	NANO 12	408	STEP 3	126
A2 100	440	CABLAGGIO MX	290	GAMMA 450	208	NANO 35	408	STEP 1/30	400
A2 200	440	CASSAFORMA INKA	394	GAMMA METAL 270	212	NANO APS	130	STEP 1/32	400
A3 100	440	CASSAFORMA KUBA	390	GAMMA METAL 370	212	NORDICA	328	STEP 1/60	400
A3 200	440	CASSAFORMA KUBAMINI	390	GAMMA METAL 470	212	NORDICA/T2	366	STEP 1/62	400
A4 100	440	CASSAFORMA TAB1	22	GINA DX	70	NUBIS	256	STEP 2/30	400
A4 200	440	CHROME	62	GINA SX	70	OMEGA 300	238	STEP 2/32	400
A6 200	440	CHROME/G	372	GIROTONDO DX	94	OMEGA 400	238	STEP 2/60	400
A7 200	440	COSMO 300	310	GIROTONDO SX	94	OMEGA 500	238	STEP 2/62	400
A8 200	440	COSMO 400	310	GIROTONDO	330	OMEGA AP	88	STEP 3/30	400
ALICE/G	360	COSMO 500	310	GIROTONDO/G	364	OPEN 250	324	STEP 3/32	400
ALICE/P	360	COSMO 600	310	GIROTONDO/T	364	OPEN 350	324	STEP 3/60	400
ALIMENTATORE 100W-24V	9	COSMO P300	164	GIUNTO 2 ELETTR.	290	OPEN 450	324	STEP 3/62	400
ALIMENTATORE 150W-24V	9	COSMO P400	164	GIUNTO 3 ELETTR.	290	OPERA	92	STILO 400	314
ALIMENTATORE 60W-24V	9	COSMO/G200	348	GIUNTO 4 ELETTR.	290	OVETTO 230	54	STILO 400/C	314
ALMA 400	224	COSMO/G300	348	GOCCIA	96	OVETTO 350	54	STILO 500	314
ALMA 600	224	COSMO/G400	348	GRIFFE 400	220	PAGODA	56	STILO 500/C	314
AREA 300	302	COSMO/T	350	GRIFFE 600	220	PALLINO 190	86	STILO 600	314
AREA 400	302	COVER	140	GRILL 50	412	PALLINO 190 TIRANTE	86	STILO 600/C	314
AREA 500	302	CUT-OFF	356	GRILL 70	412	PALLINO 300	86	TAB LED	18
ARK 10	132	DADO	64	GRILL 85	412	PALOLED 60	388	TAB RGB	26
ARK 10/2	132	DADO PLISSE'	64	INKA 1	394	PALOLED 62	388	TAB1 LED	22
ARK 10 MIX	132	DADO/G	374	INKA 1/60	398	PALOLED 110	388	TAB1 RGB	26
ARK 20	132	DADO PLISSE'/G	374	INKA 1/62	398	PALOLED 112	388	TAB2 LED	28
ARK 20/2	132	DELTA	218	INKA 1/90	398	PARK 90	424	TAB MAXI	30
ARK 20 MIX	132	DISCO 260	232	INKA 1/92	398	PARK 92	424	TAB S1	274
ARTIKA 400	332	DISCO 310	232	INKA 2	394	PARK 180	424	TAB S2	274
ASIA AP	60	DOMO 130	100	INKA 3	394	PARK 182	424	TAB S4	274
ASIA/P	354	DOMO 300	100	ISY 50	410	PLAN 20	110	TAB SQ	274
ASIA/G	354	DUO 90	284	ISY 70	410	PLAN 30	110	TEGOLA 40	98
ASIA 250	320	DUO 120	284	ISY 85	410	PLAN 60	110	TEGOLA 60	98
ASIA 350	320	DUO 150	284	JOB 300	300	PLAN 120	110	TI-LIGHT AP	48
ASIA 550	320	DUO AP 60	42	JOB 400	300	PLAZA 90	428	TI-LIGHT/T	368
ASSO	146	DUO AP 90	42	JOB 500	300	PLAZA 92	428	TOP EXTRA	186
ASTRA 250	190	DUO/T	380	JULY/P	362	PLAZA 180	428	TOP PLUS	184
ASTRA 300	190	DUODK 90	284	JULY/G	362	PLAZA 182	428	TRILYUM AP	82
ASTRA 360	190	DUODK 120	284	K4 100	440	POLO	148	TRILYUM	340
ASTRA 450	190	DUODK 150	284	K4 200	440	POLO 60	438	TRILYUM/G	378
ASTRA 550	190	DUODK AP 60	168	K8 200	440	POLO 62	438	TRILYUM/P	378
ASTRA METAL 320	196	DUODK AP 90	168	KING	246	POLO 100	438	TRILYUM/T	378
ASTRA METAL 370	196	EQUOS 1 LED-5°	102	KIT 1	136	POLO 102	438	TRIS	382
ASTRA METAL 470	196	EQUOS 1 LED-40°	102	KIT 1/60	404	QUADRO 250	230	TUTTOTONDO 600	262
ASTRA METAL 570	196	EQUOS 1 LED-120°	102	KIT 1/62	404	QUADRO 300	230	TUTTOTONDO 600 RGB	266
ASTRA MINI 170	200	EQUOS 2 LED-5°	102	KIT 1/100	404	QUEEN	244	TUTTOTONDO 900	262
ASTRA MINI 200	200	EQUOS 2 LED-40°	102	KIT 1/102	404	RAILROAD	336	TUTTOTONDO 900 RGB	266
AURORA 250	74	EQUOS 2 LED-120°	102	KIT 2	136	REGOLO 250	228	TUTTOTONDO 1200	262
AURORA 430	74	EQUOS 2 LED-MIX	102	KIT 2/60	404	REGOLO 350	228	TUTTOTONDO 1800	262
AVALON	358	EQUOS 1	102	KIT 2/62	404	RETRO' AP	66	TUTTOTONDO P600	154
B4 200	446	EQUOS 2	102	KIT 2/100	404	RETRO' G	376	TUTTOTONDO P600 RGB	158
B4 200/2	446	EQUOS MIX	102	KIT 2/102	404	RETRO' T	376	TUTTOTONDO P900	154
B8 200	446	ERGO 60	46	KIT GRAPPOLO 2	313	RIGA	148	TUTTOTONDO P900 RGB	158
B8 200/2	446	FARO 50	414	KIT GRAPPOLO 3	313	RING 280	242	VELA	78
BAND	142	FARO 70	414	KIT GRAPPOLO 4	313	RING 350	242	VIP 1	76
BASIC	254	FARO 85	414	KIT ROSONE 150	290	ROL 1	108	VIP 2	76
BEST 50	418	FILO IP65	294	KIT ROSONE 300	290	ROL 2	108	VIP 500	166
BEST 90	418	FILTRO ARANCIONE X OPEN	324	KROS	144	SEGNO	68	VIP 501	166
BASE TIRAFONDI	418	FILTRO BLU X OPEN	324	KUBA	390	SIRYA 1	80	VISOR 50	422
BETA	216	FILTRO GIALLO X OPEN	324	KUBA 60	392	SIRYA 2	80	VISOR 90	422
BIPLAN 30	114	FILTRO ROSSO X OPEN	324	KUBA 90	392	SMART	250	VITRUM	370
BIPLAN 60	114	FLASH AS-25°	50	KUBAMINI	390	SOLARIUM	308	VOG A	52
BLIK 20	116	FLASH AL-40°	50	KYO AP	58	SPICCHIO	84	VOG P	178
BLIK 30	116	FLASH PS-25°	172	KYO	352	SPICCHIO TIRANTE	84	VOG I1	178
BLIK 60	116	FLASH PL-40°	172	LAND 50	420	SPLIT 20	34	VOG I2	178
BLIK 120	116	FLASH I1S-25°	172	LAND 90	420	SPLIT 20 IN	34	VOG I4	178
BOLLA 260	234	FLASH I1L-40°	172	LELLA 250	240	SPLIT 60	34	VOG IQ	178
BOLLA 310	234	FLASH I2S-25°	172	LELLA 300	240	SPLIT 60 IN	34	VOG S4	298
BOLLA 370	234	FLASH I2L-40°	172	LOLLO	72	SPLIT 90	34	VOG SQ	298
BOX 30A	432	FLASH I4S-25°	172	MEGA 1	90	SPLIT 120	34	WORK 370	334
BOX 30B	432	FLASH I4L-40°	172	MEGA 2	90	SPLIT 150	34	YOYO 600	268
BOX 30C	432	FLASH IQS-25°	172	MEGA 250	202	SPLITDK 60	170	YOYO 600 RGB	272
BOX 60A	432	FLASH IQL-40°	172	MEGA 350	202	SPLITDK 90	170	YOYO 900	268
BOX 60B	432	FLASH S4S-25°	296	MEGA 450	202	SPLITDK 120	170	YOYO 900 RGB	272
BOX 60C	432	FLASH S4L-40°	296	MEGA METAL 260	206	SPLITDK 150	170	YOYO P600	160
BOX 120A	432	FLASH SQS-25°	296	MEGA METAL 360	206	STAR C20	120	YOYO P600 RGB	162
BOX 120B	432	FLASH SQL-40°	296	MEGA METAL 460	206	STAR C30	120	YOYO P900	160
BOX 120C	432	FLY	252	MONO 90	278	STAR C60	120	YOYO P900 RGB	162
BOX 150A	432	FORMA	32	MONO 120	278	STAR C120	120	ZEUS	342
BOX 150B	432	FRANGILUCE 30	432	MONO 150	278	STAR L30	124		
BOX 150C	432	FRANGILUCE 60	432	MONODK 90	278	STAR L60	124		
CABLAGGIO F	290	FRANGILUCE 120	432	MONODK 120	278	STAR L120	124		
CABLAGGIO FX	290	FRANGILUCE 150	432	MONODK 150	278	STEP 1	126		

Condizioni di garanzia

Krea Design garantisce al compratore la corretta realizzazione dei propri prodotti per un periodo di due anni dalla data della compravendita. Durante il periodo di garanzia qualsiasi difetto di fabbricazione o di materiale sarà rettificato senza alcun addebito. Krea Design si riserva il diritto di rettificare il danno attraverso la riparazione, il cambio o la sostituzione del prodotto.

La garanzia non copre e il produttore non è responsabile nei seguenti casi:

- parti di materiali soggetti ad usura;
- problemi risultanti da cause esterne quali incidenti, abusi, utilizzo improprio, maneggiamento scorretto, negligenza, fuoco, furto, vandalismo, esplosioni, disastri naturali o altre cause esterne non dipendenti dalla difettosità del prodotto stesso;
- Condizioni che dimostrino una cattiva installazione, scorrette applicazioni, installazione in condizioni ambientali estreme diverse da quelle indicate nelle specifiche del prodotto stesso, situazioni di sotto o sovra tensione di alimentazione, mancato rispetto delle istruzioni, maneggiamento, trasporto, manutenzione impropri o inadeguati, negligenza, accidentalità, manomissioni del prodotto;
- Incompatibilità: realizzazioni, installazioni, operazioni di manutenzione con prodotti non supportati dal produttore;
- Situazioni in cui componenti vengono sostituiti con parti con fornite dal produttore;
- La qualità di installazione sui prodotti dell'azienda produttrice dei sopraccitati componenti non fornito dal produttore;
- Piccoli difetti che non abbiano ripercussioni sul valore o sul funzionamento dell'apparecchio.
- **Le variazioni di colore dei led ed il loro flusso luminoso sono nei limiti di tolleranza stabiliti dal costruttore dei led; esse possono variare con ogni lotto di produzione.**

Costi aggiuntivi per eventuali interventi successivi all'acquisto (es. interventi di sostituzione di parti commissionati ad aziende impiantiste esterne) vanno presentati preventivamente e concordati per iscritto dall'azienda Krea Design la quale si riserva la facoltà di approvazione dei medesimi.

Warranty conditions

Krea Design warrants to the purchaser the correct construction of its products for a period of two years from the date of purchase. During the warranty period any manufacturing defect or material will be rectified without charge. Krea Design reserves the right to correct the damage through repair, exchange or replacement of the product.

The warranty does not cover and the manufacturer is not liable in the following cases:

- parts of items subject to wear;
- problems resulting from external causes such as accidents, abuse, misuse, improper handling, neglect, fire, theft, vandalism, explosions, natural disasters or other external causes not caused by defects of the product;
- conditions which demonstrate a bad installation, improper application, installation in extreme environmental conditions other than those listed in the specifications of the product itself, situations of under or over voltage, failure to follow instructions, handling, transportation, improper or inadequate maintenance, neglect, accident, tampering with the product;
- Incompatibility: installation, maintenance products that are not supported by the manufacturer;
- Situations in which components are replaced with parts supplied by the manufacturer;
- The quality installation of products of the producer of the above mentioned components not supplied by the manufacturer;
- Small defects that do not affect the value or operation.
- **Changes in the colour of the LED and their luminous flux are within the tolerance limits specified by the manufacturer of the LED; they may change by each production batch.**

Additional costs for any action after the purchase (ex. replacements of parts ordered to external companies) must be submitted and agreed in advance in writing by Krea Design which reserves the right to approve them.

Conditions de garantie

Krea Design garantit à l'acheteur de la mise en œuvre réussie de ses produits pour une période de deux ans à compter de la date d'achat. Au cours de la période de garantie, tout défaut de fabrication ou de matériel seront rectifiés sans frais. Krea Design se réserve le droit de corriger les dommages par la réparation, l'échange ou le remplacement du produit.

La garantie ne couvre pas et le fabricant n'est pas responsable dans les cas suivants:

- Pièces d'articles soumis à l'usure;
- Les problèmes résultant de causes externes telles que les accidents, abus, mauvais usage, mauvaise manipulation, une négligence, incendie, vol, vandalisme, explosions, catastrophes naturelles ou d'autres causes extérieures non causés par des défauts du produit;
- Conditions qui démontrent une mauvaise installation, mauvaise application, l'installation dans des conditions environnementales extrêmes autres que ceux énumérés dans les spécifications du produit lui-même, les situations de sous ou surtension, défaut de suivre les instructions, la manutention, le transport,

l'entretien incorrect ou inadéquat, la négligence, un accident, une altération du produit;

- Incompatibilité: conception, installation, produits d'entretien qui ne sont pas pris en charge par le constructeur;
- Les situations dans lesquelles les composants sont remplacés par des pièces fournies par le fabricant;
- L'installation de la qualité des produits du producteur des éléments précités, non fournies par le fabricant;
- Les défauts mineurs qui n'affectent pas la valeur ou l'exploitation.
- **Changements dans la couleur des LED et de leur flux lumineux sont dans les limites de tolérance définies par le fabricant des LED; ils peuvent varier en fonction de chaque lot de production.**

Les coûts supplémentaires pour des mesures après l'achat (par exemple, les remplacements de pièces commandées à des sociétés en dehors des installations) doit être présenté et accepté à l'avance par écrit par le Krea Design qui se réserve le droit de les approuver.

Condiciones de Garantía

Krea Design garantiza al comprador la implementación exitosa de sus productos por un período de dos años a partir de la fecha de compra. Durante el período de garantía cualquier defecto de fabricación o materiales será rectificado sin cargos. Krea Design se reserva el derecho de corregir los daños mediante la reparación, cambio o sustitución del producto.

La garantía no cubre y el fabricante no se hace responsable en los siguientes casos:

- Partes de elementos sujetos a desgaste;
- Los problemas debidos a causas externas como accidentes, abuso, mal uso, mal manejo, negligencia, incendio, robo, vandalismo, explosiones, catástrofes naturales u otras causas externas no son causadas por defectos del producto;
- Condiciones que demuestran una mala instalación, aplicación incorrecta, instalación en condiciones ambientales extremas que no figuren en el pliego de condiciones del producto en sí, las situaciones de bajo o sobre voltaje, no seguir las instrucciones, la manipulación, transporte, mantenimiento incorrecto o inadecuado, negligencia, accidente, manipulación del producto;
- Incompatibilidad: diseño, instalación, productos de mantenimiento que no son apoyados por el fabricante;
- Situaciones en las que los componentes son reemplazados por las piezas suministradas por el fabricante;
- La instalación de calidad de los productos del fabricante de los componentes ya mencionados no suministrado por el fabricante;
- Los pequeños defectos que no afecten el valor o la operación.
- **Cambios en el color de los LED y su flujo luminoso están dentro los límites de tolerancia establecidos por el fabricante de los LED; que pueden variar con cada lote de producción.**

Los costos adicionales para cualquier acción después de la compra (por ejemplo, sustituciones de piezas ordenó a las empresas fuera de las instalaciones) debe ser presentada y acordada previamente por escrito por el Krea Design que se reserva el derecho de aprobar.

Garantiebedingungen

Krea Design garantiert dem Käufer die erfolgreiche Umsetzung seiner Produkte für einen Zeitraum von zwei Jahren ab dem Kaufdatum. Während der Garantiezeit einen Defekt in Material oder Verarbeitungsfehler, wird kostenlos behoben werden. Krea Design behält sich das Recht, den Schaden durch Reparatur, Austausch oder Ersatz des Produkts zu korrigieren.

Die Garantie erstreckt sich nicht und der Hersteller nicht in den folgenden Fällen haftbar:

- Teile der Begriffe Verschleiß unterliegen;
- Probleme, die sich aus äußeren Ursachen wie Unfälle, Missbrauch, unsachgemäße Behandlung, Fahrlässigkeit, Feuer, Diebstahl, Vandalismus, Explosionen, Naturkatastrophen oder andere äußere Ursachen nicht durch Mängel der Ware verursacht werden;
- Bedingungen, die eine schlechte Installation, unsachgemäße Anwendung, Installation unter extremen Umgebungsbedingungen andere als die in den Spezifikationen des Produktes selbst aufgeführt zu demonstrieren, in Situationen der Unter oder Überspannung, Versagen folgen Sie den Anweisungen, Handhabung, Transport, unsachgemäße oder unzureichende Wartung, Vernachlässigung, Unfall, Eingriffe in das Produkt;
- Inkompatibilität: Design, Installation, Wartung Produkte, die nicht vom Hersteller unterstützt werden;
- Situationen, in denen Komponenten werden mit Teilen des Herstellers ersetzt;
- Die Qualität der Installation von Produkten der Hersteller der genannten Komponenten nicht vom Hersteller geliefert werden;
- Kleine Mängel, die nicht das Wert oder die Gebrauchstauglichkeit.
- **Veränderungen in der Farbe der LED und deren Lichtstrom sind innerhalb der Toleranzgrenzen vom Hersteller der LED eingestellt; sie mit jeder Produktionscharge variieren.**

Zusätzliche Kosten für alle Maßnahmen nach dem Kauf (zB Auswechseln von Teilen bestellt Unternehmen außerhalb von Anlagen) einzureichen und im Voraus vereinbart werden schriftlich von der Krea Design, die das Recht, sie zu genehmigen Reserven.

FORO COMPETENTE: il luogo di consegna delle merci è sempre la sede di Krea Design srl. Tutti i contratti perfezionati tra Krea Design srl e il compratore si intendono stipulati in Italia e sono sottoposti alla Legge Italiana. Per qualsiasi controversia il Foro competente è quello di Como con rinuncia da parte del compratore alle competenze alternative di altri fori, previsti anche per effetto di connessione.

COMPETENT COURT: the place of delivery of goods is still the headquarters of Krea Design srl. All contracts stipulated between Krea design and the buyer shall be concluded in Italy and are subject to Italian law. For any dispute the competent court is that of Como, with renunciation by the buyer of alternate jurisdictions of other courts, even if they are connected to that of Como.

TRIBUNAL COMPÉTENT: le lieu de livraison des marchandises est toujours le siège de Krea Design srl. Tous les contrats signés entre Krea Design srl et l'acheteur sont à entendre passés en Italie et sont soumis à la loi italienne. En cas de litiges, le tribunal compétent est le tribunal de Côme avec le renoncement de la part de l'acheteur aux compétences alternatives d'autres juridictions prévues aussi par effet de lien.

TRIBUNAL COMPETENTE: el lugar convenido para la entrega de la mercancía es la sede de Krea Design srl. Todos los contratos establecidos entre Krea Design srl y el comprador se consideran estipulados en Italia y son regidos por la ley italiana. Para cualquier controversia, el tribunal competente será el de Como, y el comprador renuncia a toda jurisdicción de cualquier otro tribunal, contemplado también por motivos de conexión.

GERICHTSSTAND: Ort der Zustellung der Waren ist immer der Sitz der Krea Design Srl. Alle Verträge, die zwischen der Krea Design Srl. und dem Käufer geschlossen werden, gelten als in Italien vereinbart und unterliegen dem italienischen Recht. Bei Rechtsstreitigkeiten gleich welcher Art ist das Gericht von Como zuständig, wobei von Seiten des Käufers auf alternative Zuständigkeiten von anderen Gerichten, die auch im Fall von Zusammenhängen vorgesehen sind, verzichtet wird.

Non ci assumiamo responsabilità per errori di stampa, dimensioni, descrizioni e dati tecnici. La Società si riserva il diritto di apportare modifiche sui prodotti qui illustrati, in qualsiasi momento, senza preavviso. Sono vietate riproduzioni o copie senza autorizzazione. Il presente catalogo sostituisce tutti i precedenti.

We are not responsible for printing errors, wrong dimensions, descriptions or technical data. The Company reserves the right to amend all products herein detailed, any time and without prior notice. Unauthorized reproductions and copies are prohibited. The present catalogue replaces the previous ones.

Nous n'assumons pas la responsabilité pour des erreurs d'imprimerie, de dimensions, de descriptions et de données techniques. La Société se réserve le droit d'apporter des modifications aux produits qui sont ici illustrés, à n'importe quel moment et sans préavis. Les reproductions ou copies sans autorisation sont interdites. Ce catalogue remplace les précédents.

Asumimos nuestra responsabilidad por errores de estampado, dimensiones, descripciones y datos técnicos. La empresa se reserva el derecho de modificar los productos aquí descritos, en cualquier momento y sin necesidad de preaviso. Se prohíbe cualquier reproducción o copia sin autorización. El presente catálogo sustituye a los anteriores.

Wir übernehmen keine Haftung für Druckfehler, Maße, Beschreibungen und technische Daten. Die Gesellschaft behält sich das Recht vor, jederzeit und ohne Vorankündigung Änderungen an den hier beschriebenen Produkten vorzunehmen. Die Anfertigung von Reproduktionen bzw. Kopien ohne Genehmigung ist verboten. Dieser Katalog ersetzt alle früheren Kataloge.

art direction
RedApple ADV

graphic project
RedApple ADV
www.red-apple.it

print
CPZ

special thanks
Ivana Turconi
Silvia Castelli
Samuele Necchi
Studio Marulli

Krea Design srl è membro di:
Krea Design srl is member of:
Krea Design srl est membre de:
Krea Design srl es miembro de:
Krea Design srl ist Mitglied in:



Krea Design srl

Via Cavour 129/a
22078 Turate - Italy

Phone +39 02.96750096
Fax +39 02.96750483

Informazioni: info@kreadesign.it
Commerciale Italia: italy@kreadesign.it
Export office: world@kreadesign.it



www.kreadesign.it