



DRAPPEGGI

WIDE RANGE



SYSTEMES A CORDON KOORDSYSTEMEMEN



SLALOM 430

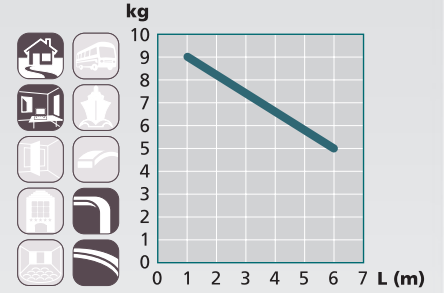
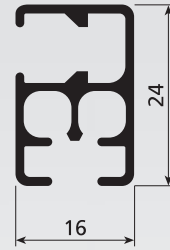
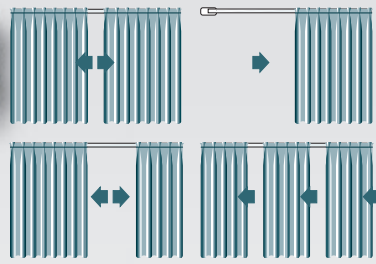

SLALOM 430

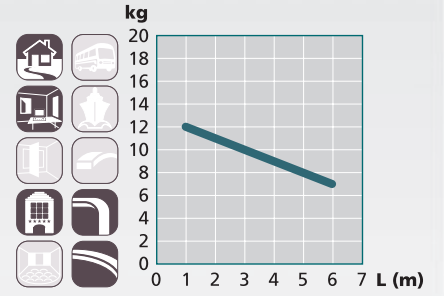
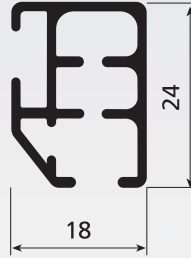
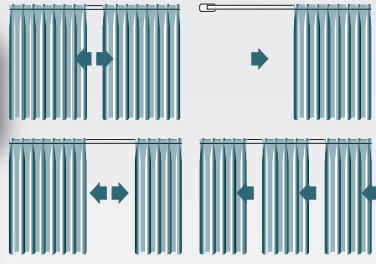

ARCO 470

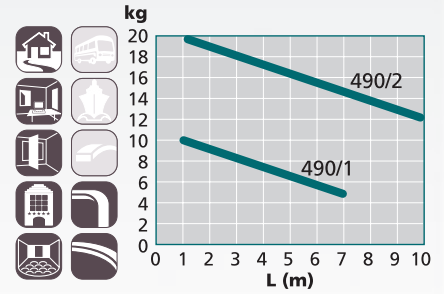
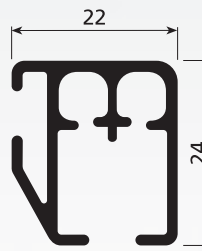
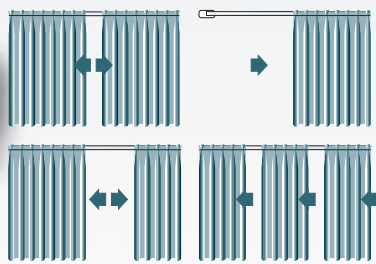

ARCO 490

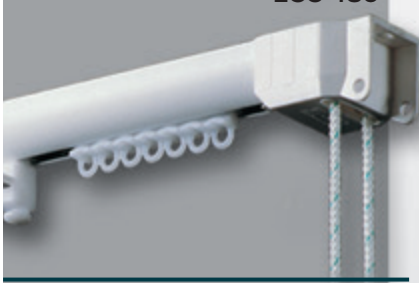
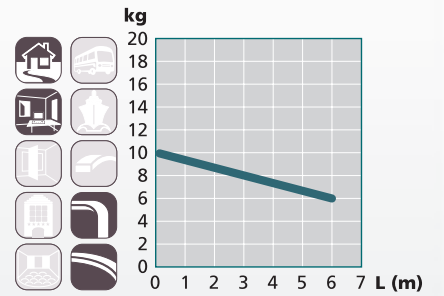
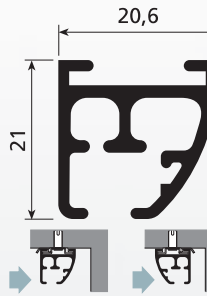
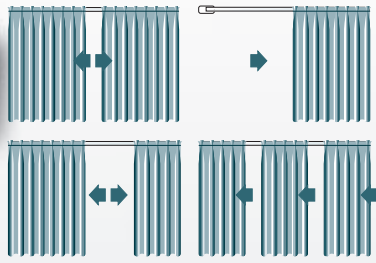

EGO 480

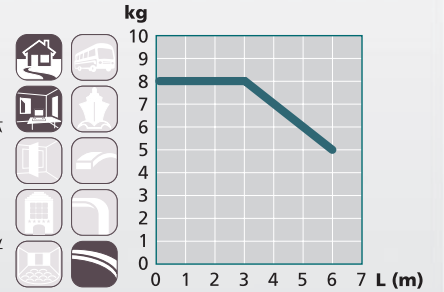
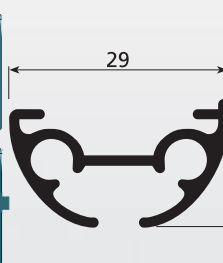
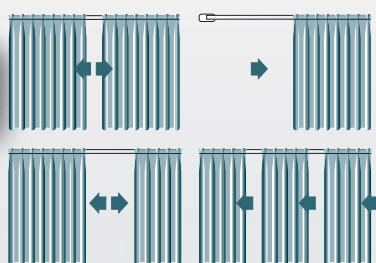

PROGETTO 420

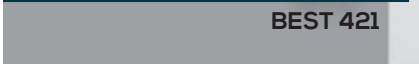
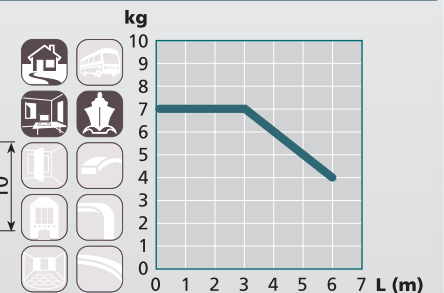
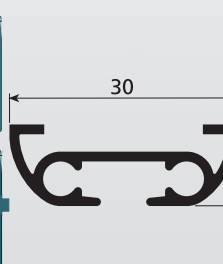
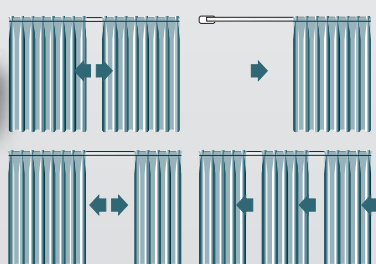

BEST 421

SYSTEMES A CORDON KOORDSYSTEMEN



ROUND 468

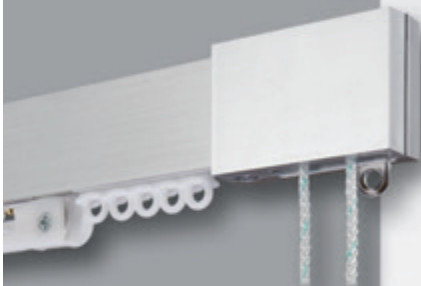
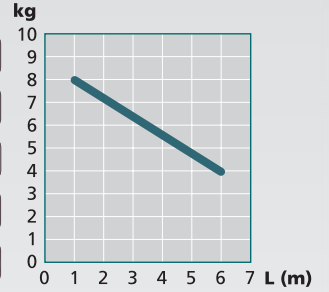
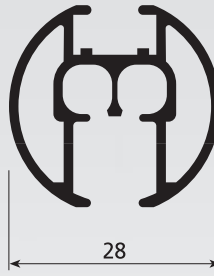
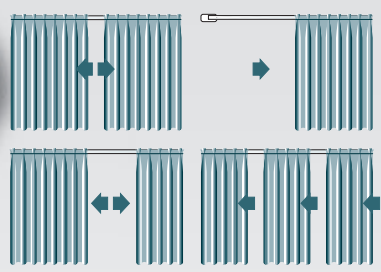

SEPARÉ 459

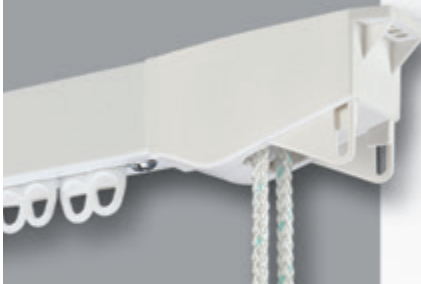
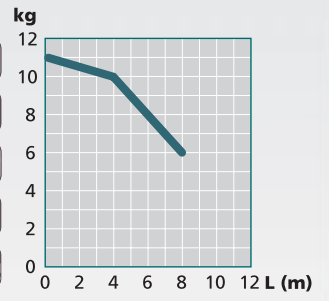
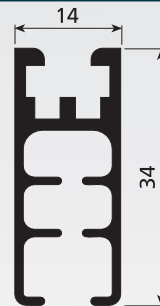
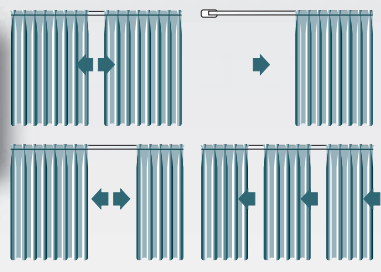

SIPARIO 202

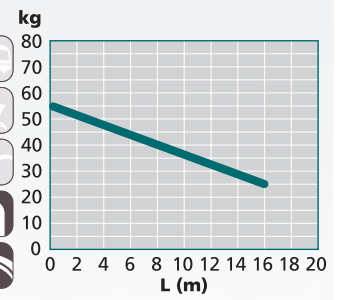
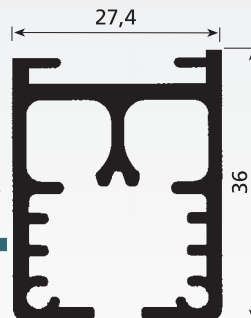
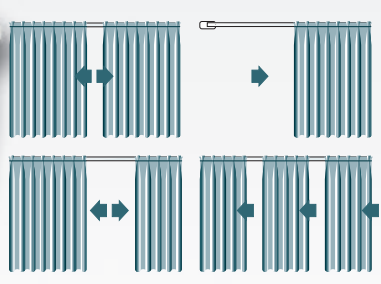

TEATRO 404

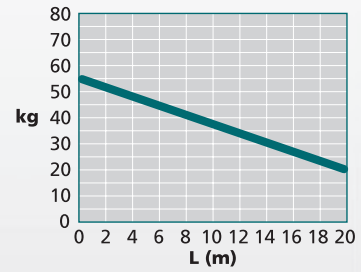
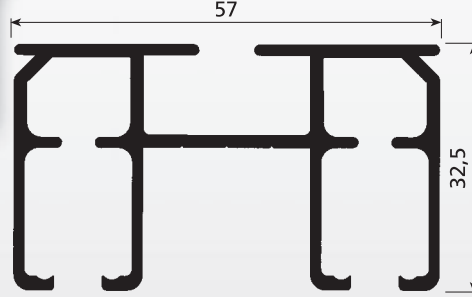

STRALYS 477

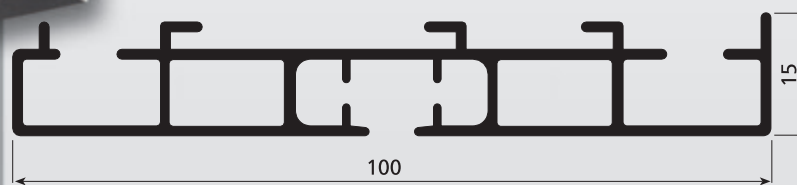
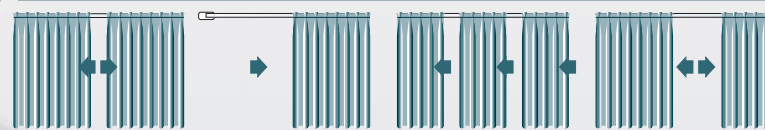

SYSTEMES MANUELS MANUELE SYSTEMEN

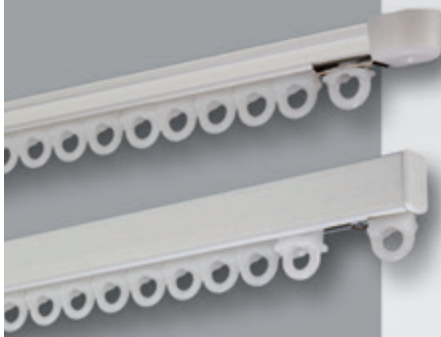

ZENITH 423 - NADIR 426

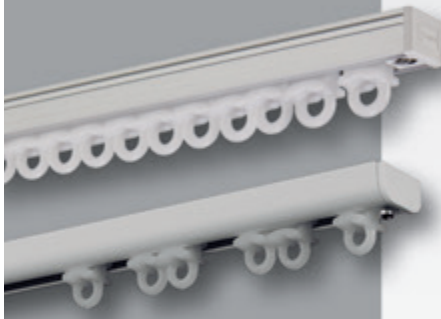
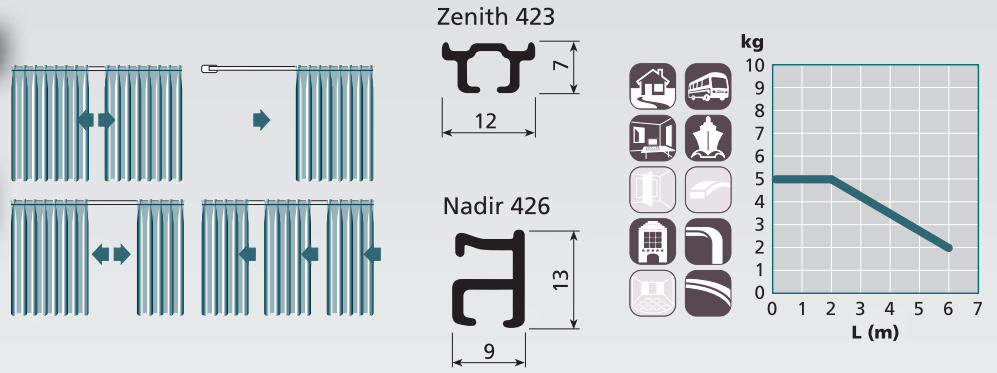

ORIZZONTE 806 - 466

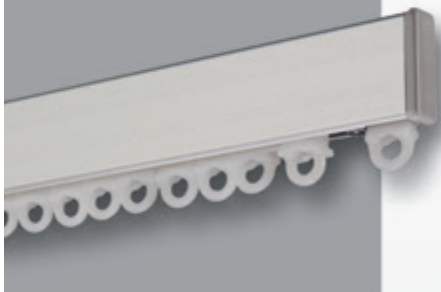
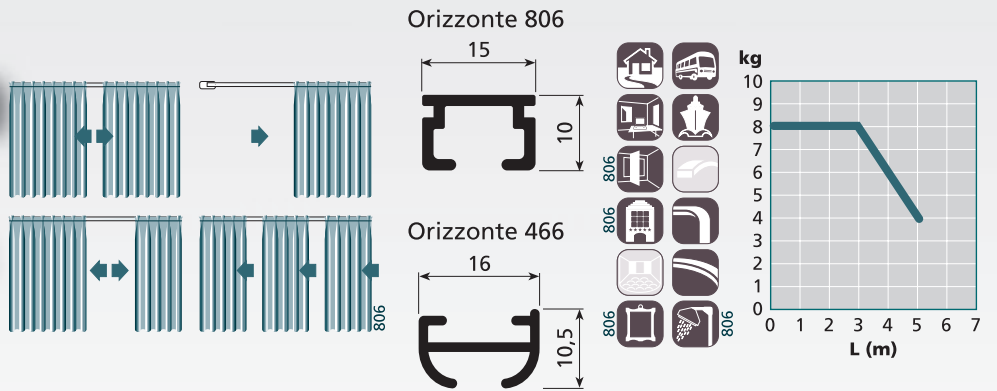

SPIN 417

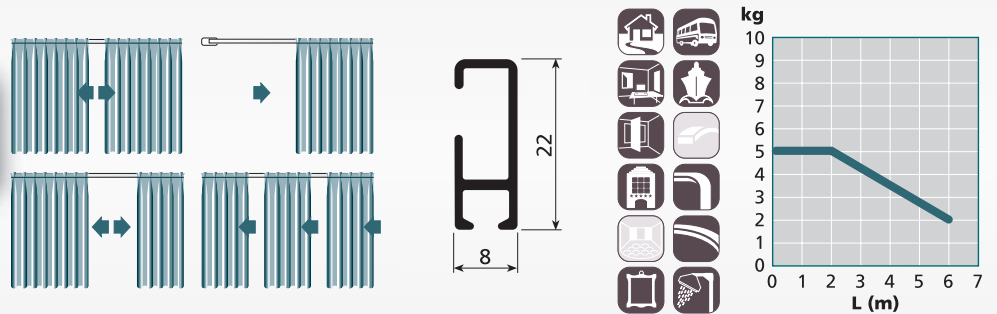

MULTIPLIO 412

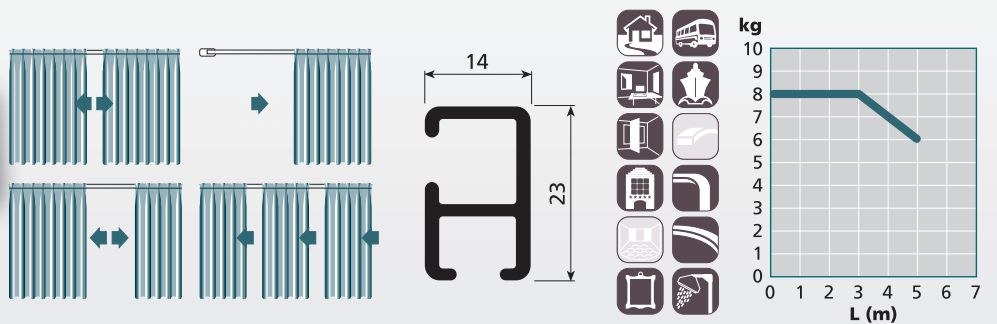

ARCO 489

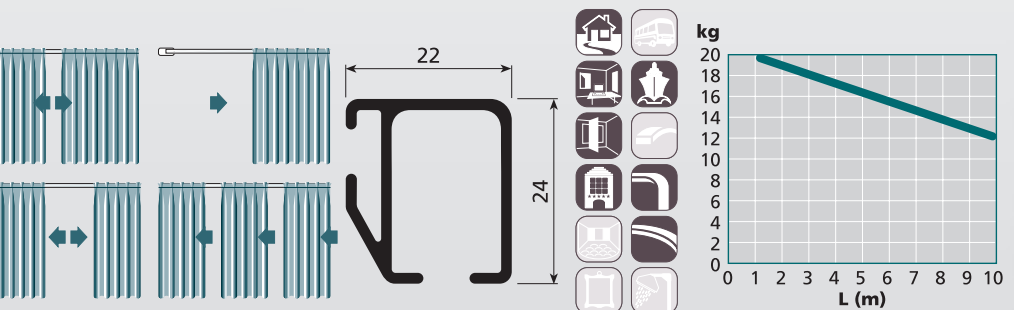

SYSTEME POUR RIDEAUX EN VAGUES

SYSTEMEN VOOR GOLFGORDIJNEN



ouverture latérale /
laterale openen

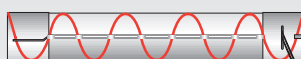

ouverture centrale /
centraal openen

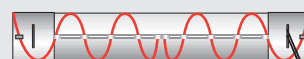

- Les systèmes Mottura, tant manuels qu'à cordon de tirage, pour rideaux en vagues. La vague en continu est obtenue grâce à un cordon muni de glisseurs/rouleurs à distance fixe.
- Mottura systemen, zowel koord- als handbediend, voor golfgordijnen. De continuele golf wordt bekomen door gebruik van een koord met glijders/rollers op vaste afstand van elkaar.

Système / Systeem



STRALYS 477	•	•
ARCO 470	•	•
EGO 480	•	•
PROGETTO 420	•	•
ROUND 468	•	•
SEPARÈ 459	•	•
SURF 324	•	•
MODULO	•	•

Système / Systeem



ROUND 464	•	
ROUND 462	•	
ROUND 460	•	
MULTIPLO 412	•	
ORIZZONTE 806	•	
ARCO 490/1	•	•
ARCO 489	•	

SYSTEMES POUR RIDEAUX MULTIPLES

SYSTEMEN VOOR MEERDERE GORDIJNEN



SURF 311

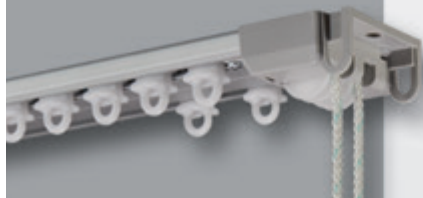
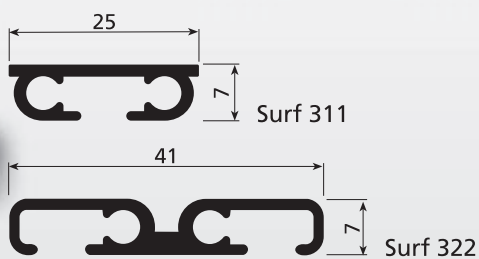
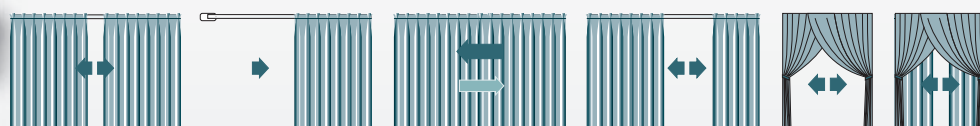

SURF 322

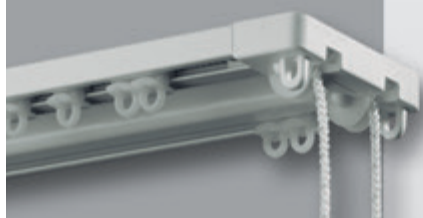
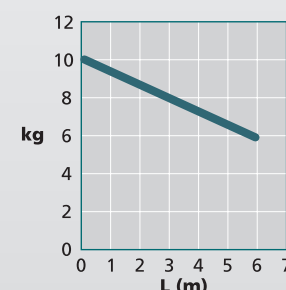
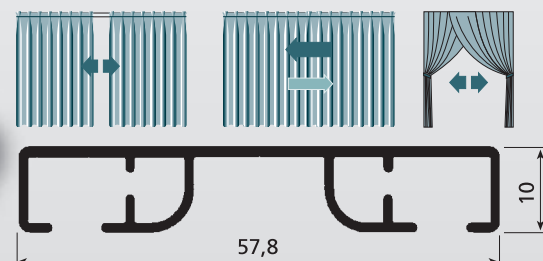

SURF 324

SYSTEMES POUR RIDEAUX MULTIPLES

SYSTEMEN VOOR MEERDERE GORDIJNEN

MODULO 105

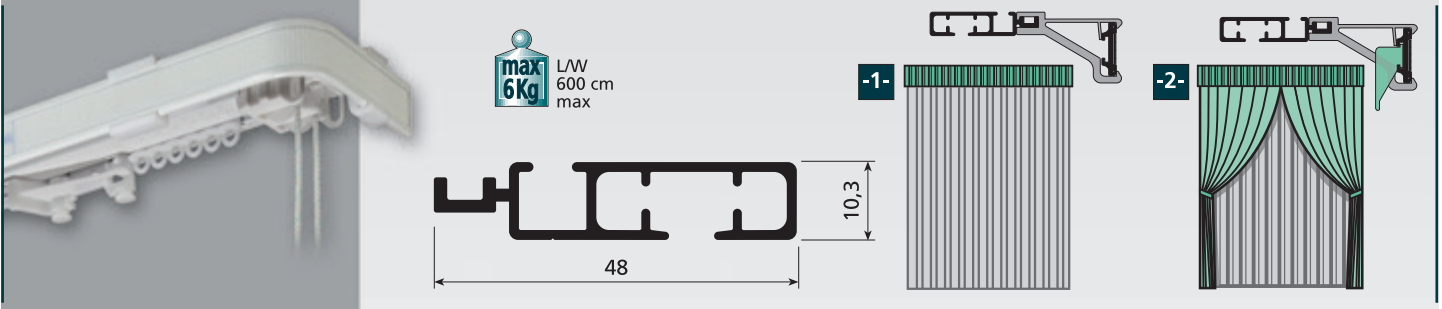

MODULO 205

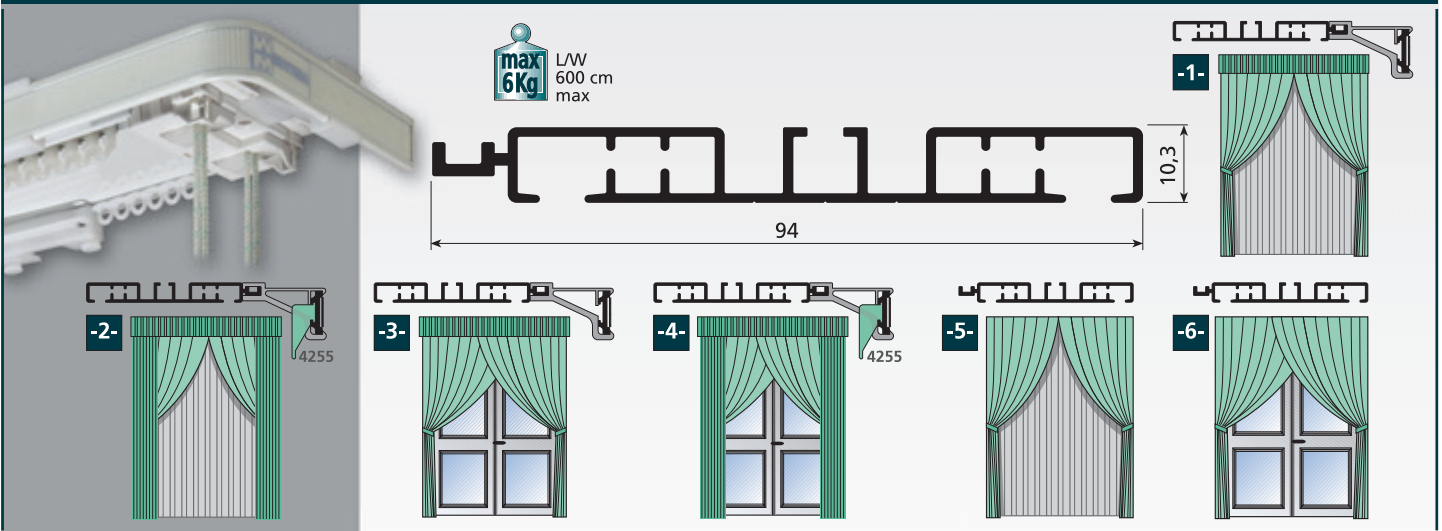

MODULO 305-306

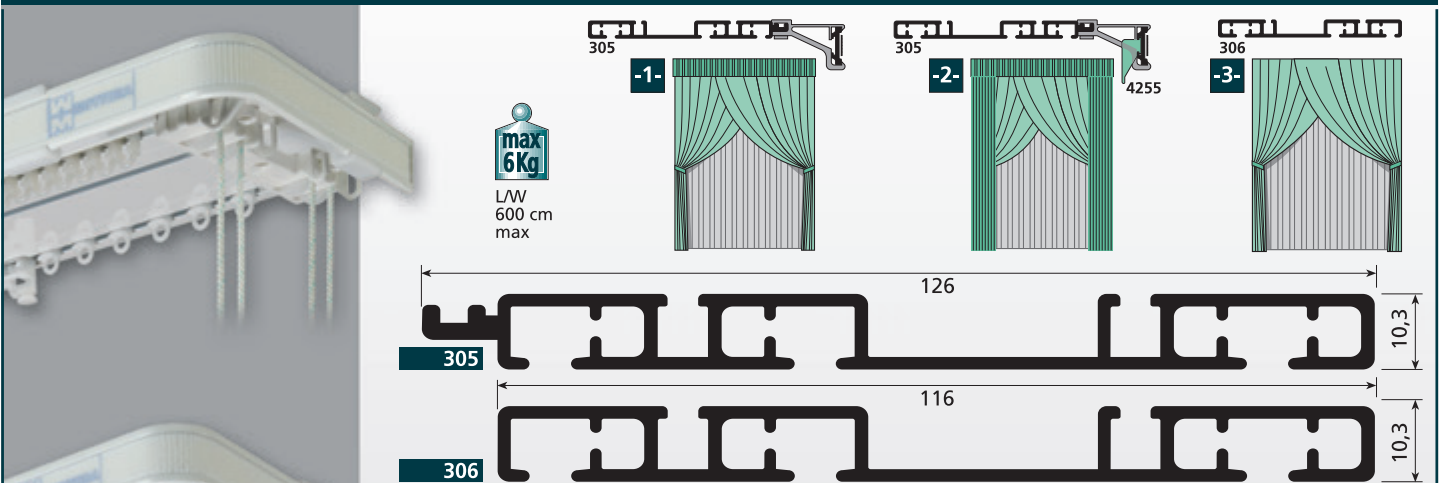

MODULO 405-406

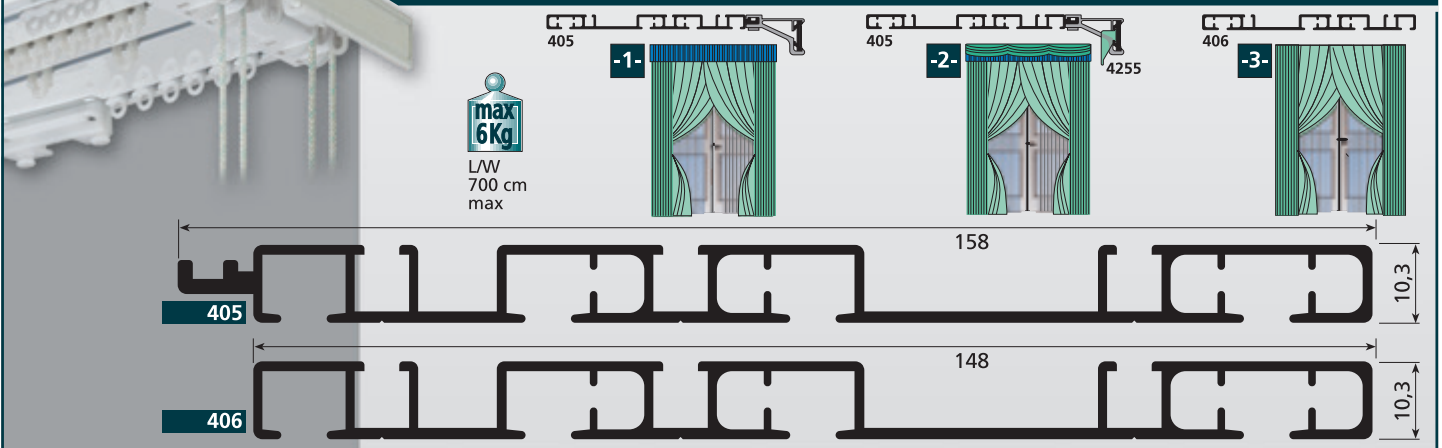

1

LA GAMME

Une gamme complète de systèmes pour usage privé ou public, pour tout type de rideaux.

HET GAMMA

Een volledig gamma systemen voor private en publieke toepassingen, voor elk type en stijl van gordijnen.

LA QUALITE

C'est notre priorité. Grâce à notre technologie sophistiquée, nous produisons des systèmes au fonctionnement souple et silencieux pour rideaux drapés, en garantissant un excellent confort d'utilisation et une longue durée de vie des produits.

DE KWALITEIT

Kwaliteit is onze eerste prioriteit. Met onze gesofistikeerde technologie kunnen we geruisloze en soepel lopende gordijnsystemen produceren, en garanderen we een uitstekende gebruiksvriendelijkheid en lange levensduur.



2

SYNERGIE

Un système Mottura est le résultat d'une technologie avancée et d'années d'expérience, qui contribuent à la constante évolution de nos produits.

SYNERGIE

Een Mottura systeem is het resultaat van een geavanceerde technologie en een jarenlange ervaring, die bijdragen tot een constante evolutie in onze producten.

MATERIEL

Mottura a des exigences très élevées et investit de manière conséquente dans la qualité en utilisant les meilleurs matériaux pour obtenir un produit final très performant.

MATERIAAL

Mottura zet hoge standaardeisen en investeert zwaar in kwaliteit, teneinde de beste materialen in te zetten om een performant eindprodukt te bekomen.



3

MOTTURA DANS LE MONDE

Nos systèmes sont distribués et utilisés dans le monde entier.

MOTTURA IN DE WERELD

Onze systemen zijn wereldwijd verspreid en gebruikt.

SECURITE

C'est également une priorité et Mottura met fortement l'accent sur une installation correcte afin d'éviter tout risque aux enfants.

VEILIGHEID

Is tevens een prioriteit, en Mottura legt sterk de nadruk op correcte installatie, om risico's voor kinderen te vermijden.

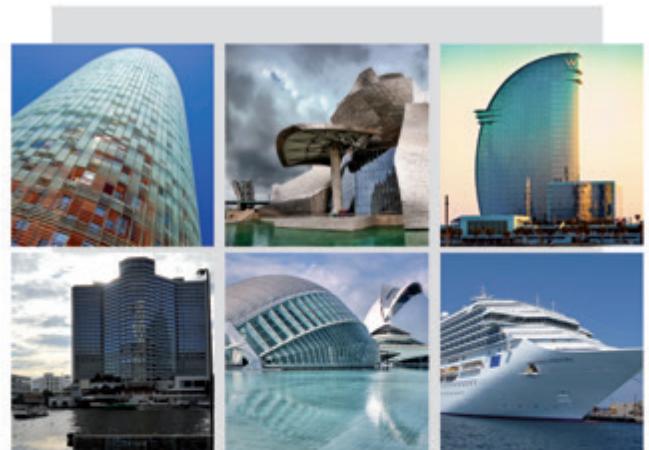

CARATTERISTICHE EIGENSCHAPPEN

SISTEMA SYSTEM			 R. min.	 R. min.	 R. min.	 Artt./Ref. 4263-4064 4361	 Artt./Ref. 4144-4330 4167-4061	 Artt./Ref. 5017-5018	 Artt./Ref. 4185-4585	 Artt./Ref. 4087 4182+4184 4181+4184
SLALOM 430 	✓	✓	12 cm	50 cm	✗	4263-4064	✗	✗	✓	✓
ARCO 470 	✓	✓	12 cm	50 cm	✗	4263-4064	✓	✗	✓	✓
ARCO 490 	✓	✓	12 cm	50 cm	✗	4263-4064	✓	✓	✓	✓ (+5327)
EGO 480 	✓	✗	12 cm	50 cm	✗	4263-4064	✓	✗	✓	✓
PROGETTO 420 	✓	✗	✗	150 cm	✗	4263-4064	✓	✗	✓	✓
BEST 421 	✓	✗	✗	✗	✗	4263-4064	✓	✗	✓	✓
ROUND 468 	✓	✓	30 cm	50 cm	✗	4263-4064	✓	✗	✓	✓
SEPARÈ 459 	✓	✓	12 cm	50 cm	✗	4263-4064	✓	✗	✓	✓
SIPARIO 202 	✓	✓	30 cm	50 cm	✗	4263-4064	✓	✓	✗	✗
TEATRO 404 	✓	✓	✗	✗	✗	4263-4064	✓	✓	✗	✗
STRALYS 477 	✓	✓	✗	✗	✗	4263-4064	✓	✗	✗	✗
ZENITH 423 	✓	✗	6/12 cm	50 cm	✗	4361	✗	✗	✗	✗
NADIR 426 	✓	✓	10 cm	50 cm	✗	4361	✗	✗	✗	✗
ORIZZONTE 806 	✓	✓	12 cm	50 cm	✗	4263-4064	✓	✗	✗	✗
ORIZZONTE 466 	✓	✓	12 cm	50 cm	✗	4263-4064	✓	✗	✗	✗
SPIN 417 	✓	✗	10 cm	50 cm	50 cm	4361	✗	✗	✗	✗
MULTIPLO 412 	✓	✓	12 cm	50 cm	✗	4263-4064	✓	✗	✗	✗
ARCO 489 	✓	✓	12 cm	50 cm	✗	4263-4064	✓	✓ (+5027/28)	✓	✓ (+5327)
SURF 311-322* 	✓	✗	✗	✗	100 cm	4263-4064	✗	✗	✓	✗
SURF 324 	✓	✗	✗	✗	✗	4263-4064	✗	✗	✓	✗
MODULO 	✓	✓	✗	✗	✗	4263-4064	✓	✗	✓	✓